



# Compliance Evaluation Report



REPORT No.: CSSC/BOS/012

ISSUED DATE: August 20, 2021

**APPLICANT :** SolaX Power Network Technology (Zhe Jiang) Co., Ltd.  
No.288, Shizhu Road, Tonglu Economic Development Zone, Tonglu  
City, Zhejiang Province 310000, P.R. CHINA

**SUBMITTED TO :** Same as above

**PRODUCT :** PV grid-connected inverter

**BRAND :** SolaX

**MODEL :** X3-Hybrid-15.0

**Scope :**

This report provides opinions for equipment compliance with the applicable standards/regulations stated in the following section. The purpose of compliance evaluation is to manifest that custom-made or imported equipment complies with the requirements of relevant standards/regulations in terms of necessary functions and settings. Local utility normally requires these opinions as a prerequisite for the first synchronization approval. The opinions are based on CSSC's evaluation of the technical evidence provided by the applicant and equipment manufacturer.

**Standards/regulations :**

Provincial Electricity Authority's Regulation on the Power Network System Interconnection Code B.E.2559 (2016)

**Technical evidence :**

Test results, product specifications and other related documents provided by the applicant

Mr. SITTICHAJ MUNGONRIT  
TEST ENGINEER

Mr. BALLANG MUENPINIJ  
HEAD of BOS TESTING UNIT

Mr. CHAMNAN LIMSAKUL  
TESTING DEPARTMENT MANAGER

(Asst. Prof. Dr. ANAWACH SANGSWANG)  
DEPUTY DIRECTOR of ACADEMIC AFFAIRS

REMARK: The authorized CSSC staff signature through electronic means shall have the same validity as a manually executed signature to the fullest extent of a paper-based report issued by CSSC.



# Compliance Evaluation Report



REPORT No.: CSSC/BOS/012

ISSUED DATE: August 20, 2021

## Product description

Brand : SolaX  
Model: X3-Hybrid-15.0

Technical specifications:

Output		Input	
Voltage	415/240V, 400/230V, 380/220V	Max. voltage	1000V
Frequency	50/60Hz nom.	Voltage range	180 – 950V MPPT
Current	24.1A max.	Current	A:26A/B:14A max.
Power	14000W nom.	Power	A:1100W/B:7000W

Remark: Referred to APPENDIX B.

## Compliance case verdicts

Complied: Submitted result complies with the requirement.  
 Does not comply: Submitted result does not comply with the requirement.  
 N/A: Not Applicable

## General remarks

This report shall not be reproduced, except in full, without the written approval of CES Solar Cells Testing Center (CSSC)

This report consists of the following documents:

- Test Compliance Validation Report
- APPENDIX A1. – List of documents from the TÜV Rheinland (Shanghai) Co., Ltd.
- APPENDIX A2. – PEA Grid Code Compliance Table.
- APPENDIX B. – X3-Hybrid Series User Manual 5.0kW – 15.0kW .
- APPENDIX C. – TÜV Rheinland’s Report No: CN21ZH49 001.
- APPENDIX D. – Laboratory Accreditation Certificate No. CNAS L3038

This report is provided without representation, warranty, or guarantee of any kind, expressed, or implied, and the CSSC provides no endorsement for any evaluated equipment, product, system or service described herein. CSSC accepts no responsibility whatsoever arising in any way from any and all use and reliance on the information contained in this report.



# Compliance Evaluation Report



REPORT No.: CSSC/BOS/012

ISSUED DATE: August 20, 2021

Test Compliance Validation			
	Technical Consideration Criteria	Submitted result - Remark	Compliance verdict / Technical comment
1	Active power control (Topic No. 12.1). A connect requestor must design an Active Power Control System to help maintaining a specified voltage level. The system must be able to decrease the electric power from 100% to 0% on a 10% per minute manner.	<p>The inverter is able to decrease the active power from 100% to 0% of nominal active power as well as be able to 10% step decrease.</p> <p>The interval time of decreasing the active power from 100% to 0% is 570.15s.</p> <p>See APPENDIX C. page 107, 12. Active power control and page 211.</p> 	Complied <sup>(1)</sup>

COPY

Ref No.: 949



# Compliance Evaluation Report



REPORT No.: CSSC/BOS/012

ISSUED DATE: August 20, 2021

Test Compliance Validation		Submitted result - Remark	Compliance verdict / Technical comment												
2	<p>Reactive Power control (Topic No. 8.1.2).</p> <p><b>Technical Consideration Criteria</b></p> <p>For a system with a converter, the power factor must be adjustable and controllable as demonstrated in the table below.</p> <table border="1" style="width: 100%; border-collapse: collapse;"> <thead> <tr> <th style="width: 25%;">Voltage Level at the Interconnection Point</th> <th style="width: 25%;">Ability to adjust the Power Factor at rated power input</th> <th style="width: 25%;">Reactive Power Control Methods</th> </tr> </thead> <tbody> <tr> <td>1) Low Voltage</td> <td>0.95 lagging - 0.95 leading or better</td> <td>At least one method: A fixed displacement factor cos <math>\theta</math></td> </tr> <tr> <td>2) Medium or High Voltage (Generation Capacity <math>\leq</math> 500 kW)</td> <td>0.90 lagging to 0.90 leading or better</td> <td>At least two methods: 1) A fixed displacement factor cos <math>\theta</math> 2) A variable reactive power depending on the voltage Q(U)</td> </tr> <tr> <td>3) Medium to High Voltage (Generation Capacity &gt;500 kW )</td> <td></td> <td></td> </tr> </tbody> </table> <p><b>Power Factor Adjustment and Reactive Electrical Power Control in System with Converter</b></p>	Voltage Level at the Interconnection Point	Ability to adjust the Power Factor at rated power input	Reactive Power Control Methods	1) Low Voltage	0.95 lagging - 0.95 leading or better	At least one method: A fixed displacement factor cos $\theta$	2) Medium or High Voltage (Generation Capacity $\leq$ 500 kW)	0.90 lagging to 0.90 leading or better	At least two methods: 1) A fixed displacement factor cos $\theta$ 2) A variable reactive power depending on the voltage Q(U)	3) Medium to High Voltage (Generation Capacity >500 kW )			<p>Generation Capacity <math>\leq</math> 500 kW</p> <p>1. A fixed displacement factor cos <math>\theta</math></p> <p>1.1. The inverter is adjustable and controllable at 0.95 lagging power factor.</p> <p>- 10% Pn : <b>1488.35W and -545.50VAr</b></p> <p>- 100% Pn : <b>14065.62W and -5121.7VAr</b></p> <p>1.2. The inverter is adjustable and controllable at 0.95 leading power factor.</p> <p>- 10% Pn : <b>1481.12W and 550.02VAr</b></p> <p>- 100% Pn : <b>14050.90W and 5104.14VAr</b></p> <p>See APPENDIX C, page 90 - 91, 6.1. A fixed displacement factor cos<math>\theta</math>.</p>	<p>Completed <sup>(1)</sup></p> <div style="text-align: right;"> </div>
Voltage Level at the Interconnection Point	Ability to adjust the Power Factor at rated power input	Reactive Power Control Methods													
1) Low Voltage	0.95 lagging - 0.95 leading or better	At least one method: A fixed displacement factor cos $\theta$													
2) Medium or High Voltage (Generation Capacity $\leq$ 500 kW)	0.90 lagging to 0.90 leading or better	At least two methods: 1) A fixed displacement factor cos $\theta$ 2) A variable reactive power depending on the voltage Q(U)													
3) Medium to High Voltage (Generation Capacity >500 kW )															



# Compliance Evaluation Report



REPORT No.: CSSC/BOS/012

ISSUED DATE: August 20, 2021

Test Compliance Validation		
Technical Consideration Criteria	Submitted result - Remark	Compliance verdict / Technical comment
2 Reactive Power control (Topic No. 8.1.2). (Cont.)	Generation Capacity > 500 kW 1. A fixed displacement factor $\cos \theta$ 1.1 The inverter is adjustable and controllable at 0.90 lagging power factor. - 1.2 The inverter is adjustable and controllable at 0.90 leading power factor. 	N/A

COPY

Ref No.: 949



# Compliance Evaluation Report



REPORT No.: CSSC/BOS/012

ISSUED DATE: August 20, 2021

Test Compliance Validation		
Technical Consideration Criteria	Submitted result - Remark	Compliance verdict / Technical comment
2 Reactive Power control (Topic No. 8.1.2). (Cont.)	Generation Capacity > 500 kW 2. A variable reactive power depending on the voltage Q(U) 2.1 Voltage set point 0.93Vh - 0.90Vh - 2.2 Voltage set point 1.07Vh - 1.10Vh - 	N/A

COPY

Ref No.: 949



# Compliance Evaluation Report



REPORT No.: CSSC/BOS/012

ISSUED DATE: August 20, 2021

Test Compliance Validation			
Technical Consideration Criteria		Submitted result - Remark	Compliance verdict / Technical comment
3	Under/Over frequency protection (Topic No. 8.2).	<p>Maximum trip time :</p> <p><math>f &lt; 47\text{Hz} = 0.062\text{s}</math></p> <p><math>f &gt; 52\text{Hz} = 0.062\text{s}</math></p> <p>See APPENDIX C, page 106, 11. Over/Under frequency and page 208 – 209.</p> 	Complied <sup>(1)</sup>

COPY

Ref No.: 949



# Compliance Evaluation Report



REPORT No.: CSSC/BOS/012

ISSUED DATE: August 20, 2021

Test Compliance Validation											
Technical Consideration Criteria	Submitted result - Remark	Compliance verdict / Technical comment									
<p>4 Voltage Fluctuation (Topic No. 8.3).</p> <p>A connection requester must design, install, and regulate his equipment in the manner that will not cause voltage fluctuation at the point of common coupling (PCC) that is excess of the levels acceptable to PEA, as specified in the Voltage Fluctuation Regulation for Business and Industrial Customers shown in Attachment 3. The Voltage Fluctuation Regulation could be reviewed and re-considered from time to time.</p> <p>PRC/PGO-02/1998. The limits for the utility voltage at PCC less than 115kV are as follow:</p> <p>Short-Term severity Values (Pst) not exceed 1.0</p> <p>Long-Term severity Values (Plt) not exceed 0.8</p> <p>• ตารางที่ 6-1 ขีด จำกัด สำหรับ ค่าความรุนแรงของโวลเทจหรือระยะสั้น (Pst) และค่าความรุนแรงของโวลเทจหรือระยะยาว (Plt) เมื่อรวมแหล่งกำเนิดแรงดันกระแสที่เชื่อมกับระบบที่มีจุดต่อระบบไฟฟ้า ณ จุดใดๆ</p> <table border="1"> <thead> <tr> <th>ระดับแรงดันไฟฟ้า ที่จุดต่อรวม</th> <th>Pst</th> <th>Plt</th> </tr> </thead> <tbody> <tr> <td>115 kV หรือต่ำกว่า</td> <td>1.0</td> <td>0.8</td> </tr> <tr> <td>มากกว่า 115 kV</td> <td>0.8</td> <td>0.6</td> </tr> </tbody> </table>	ระดับแรงดันไฟฟ้า ที่จุดต่อรวม	Pst	Plt	115 kV หรือต่ำกว่า	1.0	0.8	มากกว่า 115 kV	0.8	0.6	<p>Test procedure referred to IEC 61000-3-11</p> <p>Pst (max) = 0.58</p> <p>Plt (max) = 0.43</p> <p>See APPENDIX C. page 86-87, 4.Flicker</p> 	<p>Complied <sup>(1)</sup></p>
ระดับแรงดันไฟฟ้า ที่จุดต่อรวม	Pst	Plt									
115 kV หรือต่ำกว่า	1.0	0.8									
มากกว่า 115 kV	0.8	0.6									





# Compliance Evaluation Report



REPORT No.: CSSC/BOS/012

ISSUED DATE: August 20, 2021

Test Compliance Validation			
Technical Consideration Criteria		Submitted result - Remark	Compliance verdict / Technical comment
5	<p>Harmonics (Topic No. 8.4).</p> <p>A connection requester must design, install, and control his equipment in the manner that will not cause frequency and current distortion at the point of common coupling (PCC) that is excess of the levels acceptable to PEA, as specified in the Harmonic Regulation for business and Industrial Customers shown in Attachment 4. The Harmonic Regulation may be reviewed from time to time.</p>	<p>Test procedure referred to IEC61000-3-12</p> <p>%THDi (max) = 3.65%</p> <p>%THDv (max) = 0.46% (at rated output power)</p> <p>2<sup>nd</sup> – 33<sup>rd</sup> Current harmonics are in limit in accordance to IEC61727.</p> 	<p>Complied <sup>(1)</sup></p>

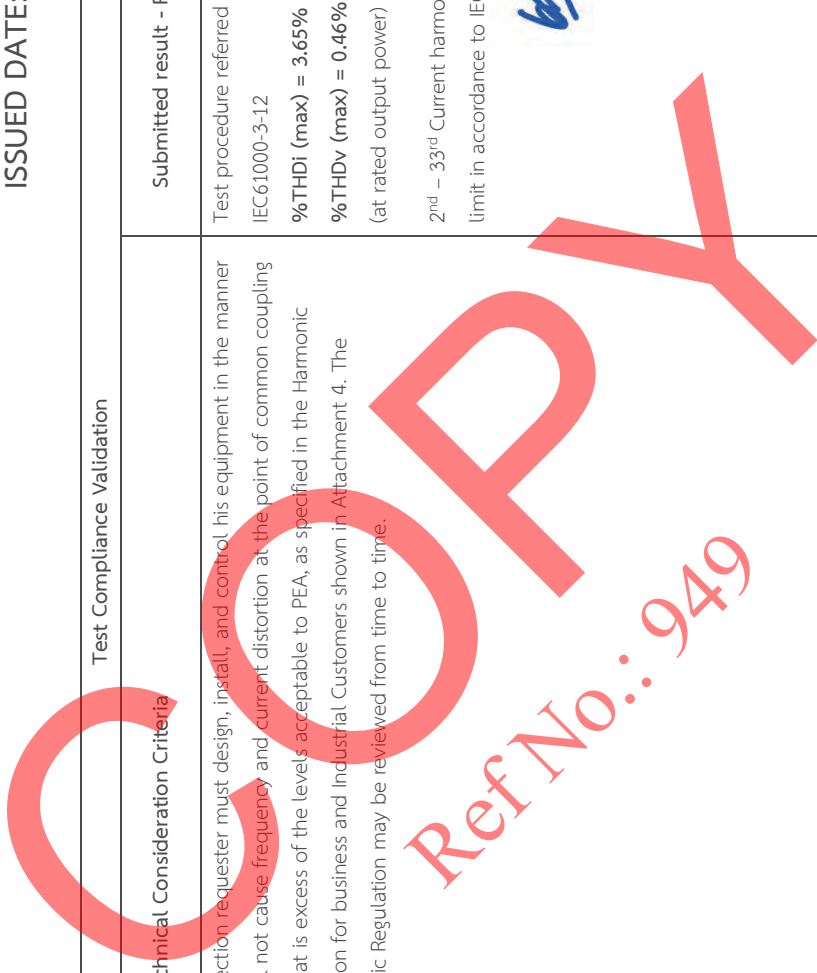



# Compliance Evaluation Report



REPORT No.: CSSC/BOS/012

ISSUED DATE: August 20, 2021

Test Compliance Validation		Submitted result - Remark	Compliance verdict / Technical comment																																																																																																																																																																									
5	<p>Harmonics (Topic No. 8.4).</p> <p>(Cont.)</p> <p><b>ตารางที่ 5-1</b> ข้อมูลค่ากระแสความถี่ฮาร์มอนิกสำหรับผู้ใช้ไฟฟ้าแรงดันที่จุดต่อร่วม*</p> <table border="1"> <thead> <tr> <th>ระดับแรงดันไฟฟ้าที่จุดต่อร่วม (kV)</th> <th>2</th><th>3</th><th>4</th><th>5</th><th>6</th><th>7</th><th>8</th><th>9</th><th>10</th><th>11</th><th>12</th><th>13</th><th>14</th><th>15</th><th>16</th><th>17</th><th>18</th><th>19</th> </tr> </thead> <tbody> <tr> <td>0-400</td> <td>48</td><td>34</td><td>22</td><td>56</td><td>11</td><td>40</td><td>9</td><td>8</td><td>7</td><td>19</td><td>6</td><td>16</td><td>3</td><td>5</td><td>5</td><td>6</td><td>4</td><td>6</td> </tr> <tr> <td>11 and 12</td> <td>13</td><td>8</td><td>6</td><td>10</td><td>4</td><td>8</td><td>3</td><td>3</td><td>3</td><td>7</td><td>2</td><td>6</td><td>2</td><td>2</td><td>2</td><td>2</td><td>1</td><td>1</td> </tr> <tr> <td>22, 24 and 33</td> <td>11</td><td>7</td><td>5</td><td>9</td><td>4</td><td>6</td><td>3</td><td>2</td><td>2</td><td>6</td><td>2</td><td>5</td><td>2</td><td>4</td><td>1</td><td>2</td><td>1</td><td>1</td> </tr> <tr> <td>69</td> <td>8</td><td>5</td><td>9</td><td>4</td><td>3</td><td>3</td><td>3</td><td>3</td><td>3</td><td>3</td><td>3</td><td>3</td><td>3</td><td>3</td><td>3</td><td>3</td><td>3</td><td>3</td> </tr> <tr> <td>115 and above</td> <td>5</td><td>4</td><td>3</td><td>4</td><td>2</td><td>3</td><td>1</td><td>1</td><td>1</td><td>1</td><td>3</td><td>1</td><td>3</td><td>1</td><td>1</td><td>1</td><td>1</td><td>1</td> </tr> </tbody> </table> <p><b>ตารางที่ 5-2</b> ขีดจำกัดความถี่ฮาร์มอนิกของแรงดันสำหรับผู้ใช้ไฟฟ้าแรงดันที่จุดต่อร่วม (ตามที่ระบุค่าความถี่ที่มีอยู่)</p> <table border="1"> <thead> <tr> <th rowspan="2">ระดับแรงดันไฟฟ้าที่จุดต่อร่วม (kV)</th> <th colspan="2">ค่าความถี่ฮาร์มอนิกของแรงดัน</th> </tr> <tr> <th>อันดับที่</th> <th>อันดับที่</th> </tr> </thead> <tbody> <tr> <td>0-400</td> <td>5</td> <td>4</td> </tr> <tr> <td>11, 12, 22 and 24</td> <td>4</td> <td>3</td> </tr> <tr> <td>33</td> <td>3</td> <td>2</td> </tr> <tr> <td>69</td> <td>2.45</td> <td>1.63</td> </tr> <tr> <td>115 and above</td> <td>1.5</td> <td>1</td> </tr> </tbody> </table>	ระดับแรงดันไฟฟ้าที่จุดต่อร่วม (kV)	2	3	4	5	6	7	8	9	10	11	12	13	14	15	16	17	18	19	0-400	48	34	22	56	11	40	9	8	7	19	6	16	3	5	5	6	4	6	11 and 12	13	8	6	10	4	8	3	3	3	7	2	6	2	2	2	2	1	1	22, 24 and 33	11	7	5	9	4	6	3	2	2	6	2	5	2	4	1	2	1	1	69	8	5	9	4	3	3	3	3	3	3	3	3	3	3	3	3	3	3	115 and above	5	4	3	4	2	3	1	1	1	1	3	1	3	1	1	1	1	1	ระดับแรงดันไฟฟ้าที่จุดต่อร่วม (kV)	ค่าความถี่ฮาร์มอนิกของแรงดัน		อันดับที่	อันดับที่	0-400	5	4	11, 12, 22 and 24	4	3	33	3	2	69	2.45	1.63	115 and above	1.5	1	<p>Current harmonics results according to IEC61727:2004.</p> <table border="1"> <thead> <tr> <th>Order</th> <th>Limits (%)</th> <th>Maximum value (%)</th> </tr> </thead> <tbody> <tr> <td>3 - 9</td> <td>&lt; 4.0</td> <td>order 5, 2.86</td> </tr> <tr> <td>11 - 15</td> <td>&lt; 2.0</td> <td>order 11, 0.89</td> </tr> <tr> <td>17 - 21</td> <td>&lt; 1.5</td> <td>order 17, 0.19</td> </tr> <tr> <td>23 - 33</td> <td>&lt; 0.6</td> <td>order 25, 0.14</td> </tr> </tbody> </table> <table border="1"> <thead> <tr> <th>Order</th> <th>Limits (%)</th> <th>Maximum value (%)</th> </tr> </thead> <tbody> <tr> <td>2 - 8</td> <td>&lt; 1.0</td> <td>order 2, 0.85</td> </tr> <tr> <td>10 - 32</td> <td>&lt; 0.5</td> <td>order 10, 0.05</td> </tr> </tbody> </table> <p>Voltage harmonics results.</p> <table border="1"> <thead> <tr> <th>Order</th> <th>Limits (%)</th> <th>Maximum value (%)</th> </tr> </thead> <tbody> <tr> <td>3 - 33</td> <td>&lt; 4.0</td> <td>order 5, 0.28</td> </tr> </tbody> </table> <table border="1"> <thead> <tr> <th>Order</th> <th>Limits (%)</th> <th>Maximum value (%)</th> </tr> </thead> <tbody> <tr> <td>2 - 32</td> <td>&lt; 2.0</td> <td>order 2, 0.03</td> </tr> </tbody> </table>	Order	Limits (%)	Maximum value (%)	3 - 9	< 4.0	order 5, 2.86	11 - 15	< 2.0	order 11, 0.89	17 - 21	< 1.5	order 17, 0.19	23 - 33	< 0.6	order 25, 0.14	Order	Limits (%)	Maximum value (%)	2 - 8	< 1.0	order 2, 0.85	10 - 32	< 0.5	order 10, 0.05	Order	Limits (%)	Maximum value (%)	3 - 33	< 4.0	order 5, 0.28	Order	Limits (%)	Maximum value (%)	2 - 32	< 2.0	order 2, 0.03
ระดับแรงดันไฟฟ้าที่จุดต่อร่วม (kV)	2	3	4	5	6	7	8	9	10	11	12	13	14	15	16	17	18	19																																																																																																																																																										
0-400	48	34	22	56	11	40	9	8	7	19	6	16	3	5	5	6	4	6																																																																																																																																																										
11 and 12	13	8	6	10	4	8	3	3	3	7	2	6	2	2	2	2	1	1																																																																																																																																																										
22, 24 and 33	11	7	5	9	4	6	3	2	2	6	2	5	2	4	1	2	1	1																																																																																																																																																										
69	8	5	9	4	3	3	3	3	3	3	3	3	3	3	3	3	3	3																																																																																																																																																										
115 and above	5	4	3	4	2	3	1	1	1	1	3	1	3	1	1	1	1	1																																																																																																																																																										
ระดับแรงดันไฟฟ้าที่จุดต่อร่วม (kV)	ค่าความถี่ฮาร์มอนิกของแรงดัน																																																																																																																																																																											
	อันดับที่	อันดับที่																																																																																																																																																																										
0-400	5	4																																																																																																																																																																										
11, 12, 22 and 24	4	3																																																																																																																																																																										
33	3	2																																																																																																																																																																										
69	2.45	1.63																																																																																																																																																																										
115 and above	1.5	1																																																																																																																																																																										
Order	Limits (%)	Maximum value (%)																																																																																																																																																																										
3 - 9	< 4.0	order 5, 2.86																																																																																																																																																																										
11 - 15	< 2.0	order 11, 0.89																																																																																																																																																																										
17 - 21	< 1.5	order 17, 0.19																																																																																																																																																																										
23 - 33	< 0.6	order 25, 0.14																																																																																																																																																																										
Order	Limits (%)	Maximum value (%)																																																																																																																																																																										
2 - 8	< 1.0	order 2, 0.85																																																																																																																																																																										
10 - 32	< 0.5	order 10, 0.05																																																																																																																																																																										
Order	Limits (%)	Maximum value (%)																																																																																																																																																																										
3 - 33	< 4.0	order 5, 0.28																																																																																																																																																																										
Order	Limits (%)	Maximum value (%)																																																																																																																																																																										
2 - 32	< 2.0	order 2, 0.03																																																																																																																																																																										



See APPENDIX C. page 102 - 105,  
10. Harmonic and waveform distortion



# Compliance Evaluation Report



REPORT No.: CSSC/BOS/012

ISSUED DATE: August 20, 2021

Test Compliance Validation		
Technical Consideration Criteria	Submitted result - Remark	Compliance verdict / Technical comment
<p>6 DC injection (Topic No. 8.5):</p> <p>A connection requester possessing a converter system must design a protection system so that the direct current dispatched to the power network system at the interconnection point will not exceed 0.5% of the rated current of the converter.</p>	<p>Test procedure referred to IEEE1547.1 clause 5.6</p> <p>Maximum DC current injection is <b>0.013A (0.06 % of 21.27A)</b></p> <p>See APPENDIX C. page 88,</p> <p>5. DC Injection and page 210.</p>	<p>Complied <sup>(1)</sup></p> 

COPY

Ref No.: 949



# Compliance Evaluation Report



REPORT No.: CSSC/BOS/012

ISSUED DATE: August 20, 2021

Test Compliance Validation			Compliance verdict / Technical comment								
Technical Consideration Criteria	Submitted result - Remark										
<p>7 Low voltage fault ride through (Topic No. 12.2).</p> <p>When encountering low voltage fault, a connection requester's generator must not immediately disconnect itself from its power network system and stay connected for a certain period of time. The voltage level at the interconnection point must be maintained as follows:</p> <p>The Period at which a Generator Must Stay Connected to Its Power Network System during a Temporary Low Voltage Fault</p> <table border="1"> <thead> <tr> <th>Voltage Level at the Connecting Point</th> <th>Time Duration (Second)</th> </tr> </thead> <tbody> <tr> <td>1) Low-voltage</td> <td>Not Required</td> </tr> <tr> <td>2) Medium or High Voltage (Generation Capacity <math>\geq</math> 500 kW)</td> <td>Required</td> </tr> <tr> <td>3) Medium to High Voltage (Generation Capacity <math>&gt;</math>500 kW)</td> <td>(see below graph)</td> </tr> </tbody> </table>	Voltage Level at the Connecting Point	Time Duration (Second)	1) Low-voltage	Not Required	2) Medium or High Voltage (Generation Capacity $\geq$ 500 kW)	Required	3) Medium to High Voltage (Generation Capacity $>$ 500 kW)	(see below graph)	<p>Generation Capacity <math>\leq</math> 500 kW</p> <p>-</p> <p>Generation Capacity <math>&gt;</math> 500 kW</p> <p>-</p>	<p>N/A</p> <p>N/A</p>	
Voltage Level at the Connecting Point	Time Duration (Second)										
1) Low-voltage	Not Required										
2) Medium or High Voltage (Generation Capacity $\geq$ 500 kW)	Required										
3) Medium to High Voltage (Generation Capacity $>$ 500 kW)	(see below graph)										
<p>Low Voltage Fault Ride Through Capability</p>											



# Compliance Evaluation Report



REPORT No.: CSSC/BOS/012

ISSUED DATE: August 20, 2021

Test Compliance Validation														
Technical Consideration Criteria	Submitted result - Remark	Compliance verdict / Technical comment												
<p>8 Under/Over voltage protection (Topic No. 12.3).</p> <p>A connection requester's power generating system must be able to disconnect from its power network system if the level on Line to Neutral voltage is out of the specified level as detailed in the following table:</p> <p>The disconnecting period when encountering over or under voltage.</p> <table border="1"> <thead> <tr> <th>Voltage Level at the Connecting Point</th> <th>Disconnecting Period (Second)</th> </tr> </thead> <tbody> <tr> <td><math>V &lt; 50\%</math></td> <td>0.3</td> </tr> <tr> <td><math>50\% \leq V &lt; 90\%</math></td> <td>2.0</td> </tr> <tr> <td><math>90\% \leq V \leq 110\%</math></td> <td>Stay connected</td> </tr> <tr> <td><math>110\% &lt; V &lt; 120\%</math></td> <td>1.0</td> </tr> <tr> <td><math>V \geq 120\%</math></td> <td>0.16</td> </tr> </tbody> </table>	Voltage Level at the Connecting Point	Disconnecting Period (Second)	$V < 50\%$	0.3	$50\% \leq V < 90\%$	2.0	$90\% \leq V \leq 110\%$	Stay connected	$110\% < V < 120\%$	1.0	$V \geq 120\%$	0.16	<p>Maximum trip time:</p> <p><math>V &lt; 50\%</math> = 0.243s</p> <p><math>50\% \leq V &lt; 90\%</math> = 1.942s</p> <p><math>110\% &lt; V &lt; 120\%</math> = 0.138s</p> <p><math>V \geq 120\%</math> = 0.118s</p> <p>See APPENDIX C., page 100 – 101, 9. Over/Under voltage and page 176 - 207.</p> <p><i>balong</i></p>	<p>Complied <sup>(1)</sup></p>
Voltage Level at the Connecting Point	Disconnecting Period (Second)													
$V < 50\%$	0.3													
$50\% \leq V < 90\%$	2.0													
$90\% \leq V \leq 110\%$	Stay connected													
$110\% < V < 120\%$	1.0													
$V \geq 120\%$	0.16													



# Compliance Evaluation Report



REPORT No.: CSSC/BOS/012

ISSUED DATE: August 20, 2021

Test Compliance Validation			
	Technical Consideration Criteria	Submitted result - Remark	Compliance verdict / Technical comment
9	<p>Anti-Islanding (Topic No. 12.4).</p> <p>To prevent islanding while there is no power supply at the power network system, a connection requester's generator must be capable to disconnect from the power network system within one second (1s).</p>	<p>Test procedure referred to IEC62116 with voltage level 220V (phase to neutral voltage) Maximum run-on time: 1. Power 100% of rating, <math>P_R</math> 0%, <math>Q_L</math> 0% is 0.325s 2. Power 66% of rating, <math>P_R</math> 0%, <math>Q_L</math> 0% is 0.452s 3. Power 33% of rating, <math>P_R</math> 0%, <math>Q_L</math> 0% is 0.249s</p> <p>See APPENDIX C., page 92 – 98, 7. Islanding Protection and page 108 – 163.</p> 	Complied <sup>(1)</sup>

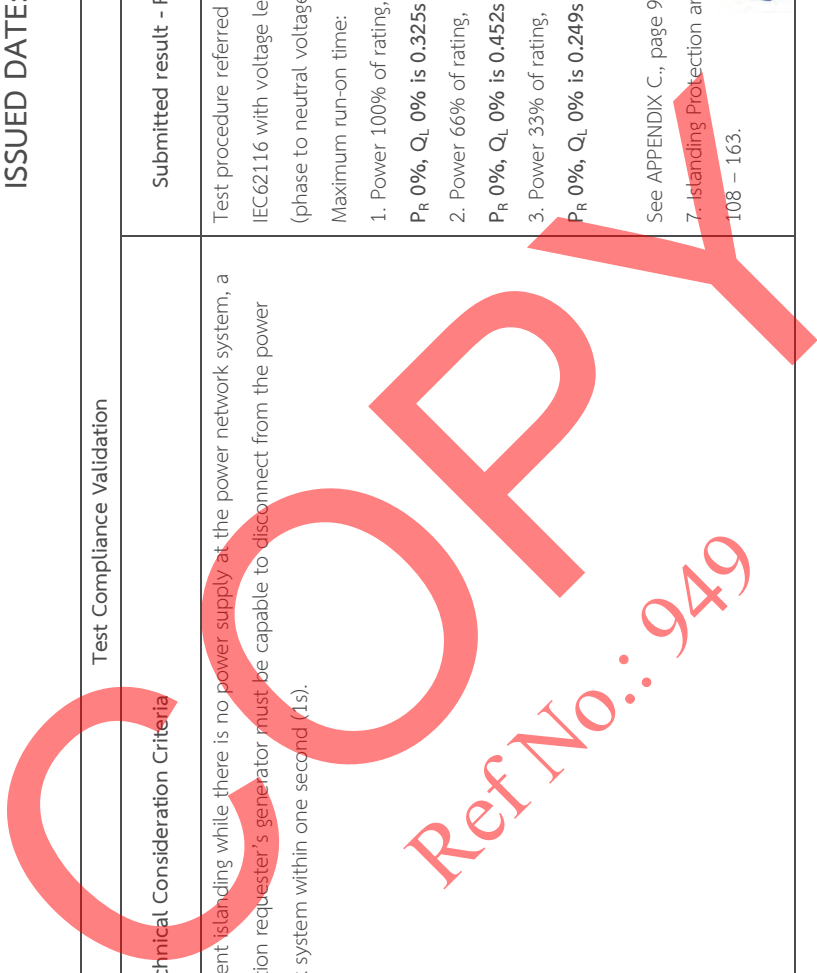



# Compliance Evaluation Report



REPORT No.: CSSC/BOS/012

ISSUED DATE: August 20, 2021

Test Compliance Validation			
	Technical Consideration Criteria	Submitted result - Remark	Compliance verdict / Technical comment
10	Response to utility recovery (Topic No. 12.5). After the disconnection, if the power network system resumes to its normal state, the connection requester's generator must be able to wait about 20 seconds to 5 minutes before re-connecting to the power network system.	Test procedure referred to IEEE1547.1 Reconnecting time: 50% < V < 90% = 121.5s 110% < V < 120% = 125.1s and f < 47Hz = 121.1s f > 52Hz = 123.3s  See APPENDIX C., page 99, 8. Response to Utility Recovery and page 164 – 175.	Complied <sup>(1)</sup>

COPY

Ref No.: 949

(1) The test results/information from an accredited third-party laboratory and are submitted to CSSC by the manufacturer/applicant. Compliance comments are provided based on the submitted values and relevant details. Details of the accredited laboratory as APPENDIX D.



# Compliance Evaluation Report



REPORT No.: CSSC/BOS/012

ISSUED DATE: August 20, 2021

APPENDIX A1. List of documents from the TÜV Rheinland (Shanghai) Co., Ltd.

TÜV Rheinland (Shanghai) Co., Ltd.  
Member of TÜV Rheinland Group



Dear Whom it may concerns ,

For compliance test report evaluation, we herewith submit following documentations to CSSC:

1. Technical specification of product : Manual.pdf
2. Test report: CN21ZH49 001.pdf
3. Laboratory accreditation: CNAS L3038 certificate-EN.pdf
4. Table of compliance: Comply table .pdf
5. Documentation list: Confirmation letter.pdf

We appreciate your valued support and would like to offer any help and varied services in the future.

With kind regards,

TÜV Rheinland (Shanghai) Co., Ltd.

Allen Hu  
Project Engineer  
Solar & Commercial Products

Allen Hu

Ref No.: 949

TÜV Rheinland (Shanghai) Co., Ltd. 莱茵技术(上海)有限公司	10-15/F, Huatsing Building, No. 88, Lane 777, West Guangzhong Road, 200072 Shanghai, P.R. China	上海市广中西路 777 弄 88 号 华清大厦 10-15 层 邮编: 200072	Tel.: (+86)21-61081188 Fax: (+86) 21-6108 1199 E-mail: info@shg.chn.tuv.com Website: www.chn.tuv.com
--	--	--	---

QMA30.105.11SHG\_7.1 Format of Notification of Test Result (Documentation in complete) / Revision date: 2008-05-14







# Compliance Evaluation Report



REPORT No.: CSSC/BOS/012

ISSUED DATE: August 20, 2021

APPENDIX A2. PEA Grid Code Compliance Table.



SolaX Power Network Technology (ZheJiang) Co., Ltd.

PEA Grid code compliance table

Item	Description	PEA requirement	Test results /Comment	Refer to Test report (or document) / page	Complied/ Does not comply
1	Voltage and Frequency	High voltage: 115kV and 69kV Medium voltage: 33kV and 22kV Low voltage: 220V 1 phase, 380V, 3 phase Frequency: 50Hz	Rated voltage: 380/400/415V, Rated frequency: 50/60Hz The product only applied to the low voltage level grid.	Refer to the name plate of product in report. CN21ZH49 001 / Page 4	Complied
2	Harmonics	Refer to IEC	Total harmonic distortion %THD (max) = 3.65% Current harmonics are in the limit according to IEC 61000-3-12	Refer to Test report CN21ZH49 001 /Page 26-29	Complied
3	Voltage fluctuation	Refer to IEC	Pst value: Pst(max) = 0.58 Plt value: Plt(max) = 0.43	Refer to Test report CN21ZH49 001 /Page 10-11	Complied
4	DC injection	Not more than 0.5% of inverter rating current.	DC injection value(max) = 0.13A of 65.22 A = 0.21% of rated current	Refer to Test report CN21ZH49 001 /Page 12 and 134	Complied
5	Reactive power control	Installation Power More than 500kW 0.9 Lag to 0.9 Lead 1) Fixed displacement factor	Installation power less than 500kW : fixed displacement factor(max): Lagging: 0.94, Leading: 0.94	Refer to Test report CN21ZH49 001 /Page 13	Complied

*Calong*



# Compliance Evaluation Report



REPORT No.: CSSC/BOS/012

ISSUED DATE: August 20, 2021

## APPENDIX A2. PEA Grid Code Compliance Table. (Cont.)

Item	Description	PEA requirement	Test results /Comment	Refer to Test report (or document /page)	Complied/ Does not comply
		2) Variable reactive power depend on voltage			
6	Active Power control	Adjustable power 10% each step from 100-0%	Adjustable power 10% each step from 100-0% results within 10min	Refer to Test report CN2121449-001 /Page 31 and 135	Complied
7	Low voltage fault Ride through	Installation Power More than 500kW, Capability with PEA wave form	Less than 500kW, no requirements	Not applicable	Not applicable
8	Under and Over voltage protection	Disconnect time of PEA requirement $V < 50\% = 0.3 \text{ Sec}$ $50\% < V < 90\% = 2.0 \text{ Sec}$ $110\% < V < 120\% = 1.0 \text{ Sec}$ $V > 120 = 0.16 \text{ Sec}$	Under and Over voltage trip time value (max): $V < 50\% = 0.243 \text{ Sec}$ $50\% < V < 90\% = 1.942 \text{ Sec}$ $110\% < V < 120\% = 0.138 \text{ Sec}$ $V > 120 = 0.118 \text{ Sec}$	Refer to Test report CN2121449-001 /Page 24-25 and 100-131	Complied
9	Under and Over frequency protection	Disconnect time of PEA requirement $f < 47 \text{ Hz} = 0.1 \text{ Sec}$ $f = 52 \text{ Hz} = 0.1 \text{ Sec}$	Under and Over frequency trip time value (max): $f < 48 \text{ Hz} = 0.62 \text{ Sec}$ $f > 51 \text{ Hz} = 0.62 \text{ Sec}$	Refer to Test report CN2121449-001 /Page 30 and 132-133	Complied
10	Anti-Islanding	Disconnect time of PEA requirement = 1 Sec Max	Trip time value (max): $P_{E1} > 100\%, P_{d0}\%, Q_{d0}\% = 0.325 \text{ Sec}$ $P_{E1} > 66\%, P_{d0}\%, Q_{d0}\% = 0.452 \text{ Sec}$ $P_{E1} > 33\%, P_{d0}\%, Q_{d0}\% = 0.249 \text{ Sec}$	Refer to Test report CN2121449-001 /Page 10-12 and 32-37	Complied

COPY

Ref No.: 012





# Compliance Evaluation Report



REPORT No.: CSSC/BOS/012

ISSUED DATE: August 20, 2021

APPENDIX A2. PEA Grid Code Compliance Table. (Cont.)

Item	Description	PEA requirement	Test results /Comment	Refer to Test report(or document) /page	Complied/ Does not comply
11	Reconnection to utility recovery	Reconnection time of PEA requirement = 20s to 5 mins	Reconnection time value: After back to specified recovery voltage range V = 90% =123.9 Sec V = 110% =125.1 Sec After back to specified frequency voltage range f = 48.0Hz =124.7 Sec f = 51.0Hz =123.5 Sec	Refer to Test report CN21ZH49 001 /Page 22 and 88-98	Complied

Allen Hu

Ref No.: 949

*balong*



# Compliance Evaluation Report



REPORT No.: CSSC/BOS/012

ISSUED DATE: August 20, 2021

APPENDIX B. X3-Hybrid Series User Manual 5.0kW – 15.0kW.





# Compliance Evaluation Report



REPORT No.: CSSC/BOS/012

ISSUED DATE: August 20, 2021

APPENDIX C. X3-Hybrid Series User Manual 5.0kW – 15.0kW. (Cont.)

Contents

<b>Contents</b>	
<b>1 Note on this Manual</b> .....	<b>03</b>
1.1 Scope of Validity.....	03
1.2 Target Group.....	03
1.3 Symbols Used.....	03
1.3.1 Important Safety Instructions.....	04
1.3.2 Explanation of Symbols.....	09
1.3.3 CE Directives.....	10
<b>2 Introduction</b> .....	<b>11</b>
2.1 Basic Features.....	11
2.2 Electrical Block Diagram of The System.....	11
2.3 Work Modes.....	14
2.4 Dimension.....	15
2.5 Terminals of Inverter.....	16
<b>3 Technical Data</b> .....	<b>17</b>
3.1 DC Input.....	17
3.2 AC Output/Input.....	17
3.3 Battery.....	18
3.4 EPS(Off-grid) Output.....	18
3.5 Efficiency, Safety and Protection.....	19
3.6 General Data.....	19
<b>4 Installation</b> .....	<b>20</b>
4.1 Check for Transport Damage.....	20
4.2 Packing List.....	20
4.3 Installation Precautions.....	22
4.4 Tool Preparation.....	23
4.5 Installation Site Conditions.....	25
4.5.1 Installation Carrier Requirements.....	25
4.5.2 Installation Requirements.....	25
4.5.3 Installation Space Requirements.....	26
4.6 Mounting.....	27

01

COPIED  
Ref No.: 049





## APPENDIX C. X3-Hybrid Series User Manual 5.0kW – 15.0kW. (Cont.)

Contents

Notes on this Manual

<b>5 Electrical Connections</b> .....	<b>30</b>
5.1 PV Connection.....	30
5.2 Grid Port and EPS(Off-grid) Output Connection.....	34
5.3 EPS(Off-grid) Block Diagram.....	35
5.4 Battery Connection.....	44
5.5 Communication Connection.....	48
5.5.1 Introduction to DRM Communication.....	48
5.5.2 Introduction to Meter/CT Communication.....	49
5.5.3 COM Communication.....	52
5.5.4 Communication Connection Steps.....	54
5.6 Grounding (mandatory).....	63
5.7 Monitoring Connection.....	66
5.8 Check All Below Steps Before Starting Inverter.....	68
5.9 Inverter Operation.....	69
<b>6 Firmware upgrading</b> .....	<b>71</b>
<b>7 Setting</b> .....	<b>75</b>
7.1 Control Panel.....	75
7.2 Menu Structure.....	76
7.3 LCD Operation.....	77
<b>8 Troubleshooting</b> .....	<b>103</b>
8.1 Trouble Shooting.....	103
8.2 Routine Maintenance.....	109
<b>9 Decommissioning</b> .....	<b>110</b>
9.1 Disassemble the Inverter.....	110
9.2 Packaging.....	110
9.3 Storage and Transportation.....	110
9.4 Waste Disposal.....	110
<b>10 Disclaimer</b> .....	<b>111</b>

### 1 Notes on this Manual

#### 1.1 Scope of Validity

This manual is an integral part of X3-Hybrid G4. It describes the assembly, installation, commissioning, maintenance and failure of the product. Please read it carefully before operating.

X3-Hybrid-5.0	X3-Hybrid-10.0
X3-Hybrid-5.0	X3-Hybrid-12.0
X3-Hybrid-8.0	X3-Hybrid-15.0

Note: X3-Hybrid G4 Series refers to the energy storage inverter that supports photovoltaic grid connected.

\*5.0 means 5.0kW.

\*D version contains "DC switch", "M" version can be connected to X3-Matebox, X3-Matebox has built-in DC switch, BAT circuit breaker, AC and EPS(Off-grid) circuit breaker, which can reduce the cost of accessories for customers. And pre-installed wiring cables and equipment can get rid of complex wiring work. Keep this manual available at any time.

#### 1.2 Target Group

This manual is for qualified electricians. The tasks described in this manual only can be performed by qualified electricians.

#### 1.3 Symbols Used

The types of safety instructions and general information appear in this document are as described below:

	<b>Danger!</b> "Danger" refers to a dangerous situation that, if not avoided, will result in a high level of risk such as serious injury or even death.
	<b>Warning!</b> "Warning" indicates a dangerous situation, which, if not avoided, may result in serious injury or death.
	<b>Caution!</b> "Caution" indicates a dangerous situation which, if not avoided, could result in minor or moderate injury.
	<b>Note!</b> "Note" provides tips that are valuable for the optimal operation of our product.

02

03





## APPENDIX C. X3-Hybrid Series User Manual 5.0kW – 15.0kW. (Cont.)

Safety

### 1.3.1 Important Safety Instructions

**Danger!**  
**Danger to life due to high voltages in the inverter!**  
 The personnel responsible for the installation, electrical connection, debugging, maintenance and fault handling operation of this product need to be trained, master the correct operation method, have the corresponding electrician qualification and safety operation knowledge.

**Caution!**  
 When the inverter is working, it is strictly forbidden to touch the shell. The temperature of the shell is high and there is a risk of scalding.

**Caution!**  
**Radiation may be harmful to health!**  
 Do not stay for a long time and keep at least 20 cm away from the inverter.

**Note!**  
**Ground PV system.**  
 Finish PV modules and photovoltaic system grounding in accordance with local requirements to achieve optimal protection of systems and personnel.

**Warning!**  
 Ensure that the input DC voltage is below the inverter limit. Excessive DC voltage and current may cause permanent damage or other losses to the inverter, which is not covered by the warranty.

**Warning!**  
 Before performing maintenance, cleaning or operation on the circuit connected to the inverter, authorized maintenance personnel must first disconnect the AC and DC power supplies of the inverter.

04

Safety

**Warning!**  
 The inverter can not be operated when it is running.

**Warning!**  
 Risk of electric shock!

Strictly follow relevant safety specifications for product installation and testing. During installation, operation or maintenance, please read carefully and follow the instructions and precautions on the inverter or user manual. If the operation is incorrect, it may cause personal and property losses. Please keep the user manual properly after use.

This inverter can only use the accessories sold and recommended by Solax, otherwise it may cause fire, electric shock or casualties. Without the authorization of our company, you may not open the inverter cover or replace the inverter parts, otherwise the warranty promise of the inverter will be invalid.

The use and operation of the inverter must be carried out in accordance with the instructions in this manual, otherwise this protection will fail and the warranty of the inverter will also fail. During working, the inverter surface temperature may exceed 60°C, please make sure the inverter cools down before touching, and make sure children can not touch.

When exposed to sunlight, photovoltaic arrays generate dangerous high DC voltages. Please follow our instructions, otherwise it will be life-threatening.

All DC and AC power sources must be disconnected from the inverter for at least 5 minutes before any wiring or electrical operation is performed on the inverter to ensure complete isolation of the inverter and avoid electric shock.

05

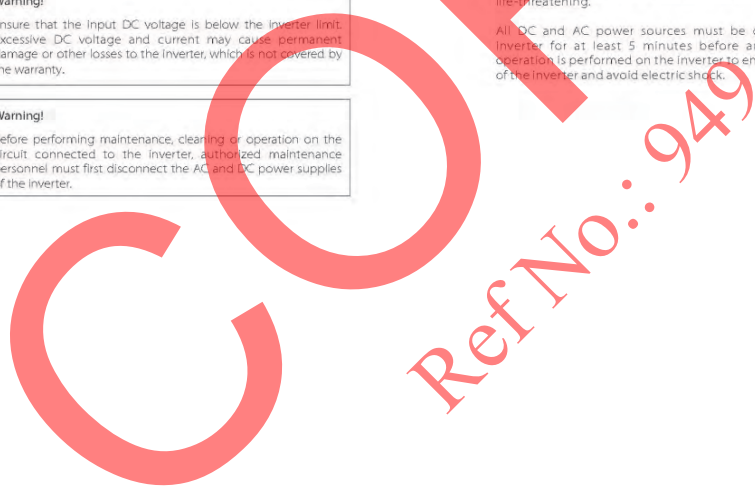



# Compliance Evaluation Report



REPORT No.: CSSC/BOS/012

ISSUED DATE: August 20, 2021

## APPENDIX C. X3-Hybrid Series User Manual 5.0kW – 15.0kW. (Cont.)

Safety

A photovoltaic module used on the inverter must have a IEC61730A rating, and the total open circuit voltage of the photovoltaic string / array is lower than the maximum rated DC input voltage of the inverter. Any damage caused by photovoltaic over voltage is not covered by warranty.

Installation position should be away from wet environment and corrosive substances.

After the inverter and power grid cut off the PV power supply, there will be a certain amount of residual current in a short time, be cautious or it may lead to serious personal injury and even high risk of death. Use a multimeter (impedance at least 1 MΩ) to measure the voltage between the UDC and the UDC- to ensure that the inverter port is discharged below the safe voltage before starting operation (35 VDC).

### ➤ Surge protection devices (SPDs) for PV installation

	<p><b>Warning!</b></p> <p>Over-voltage protection with surge arresters should be provided when the PV power system is installed. The grid connected inverter is fitted with SPDs in both PV input side and MAINS side.</p>
--	--

Direct or indirect lightning strikes can cause failures. Surge is the main cause of lightning damage to most devices. Surge voltage may occur at photovoltaic input or AC output, especially in remote mountain areas where long distance cable is supplied.

Please consult professionals before installing SPDs.

The external lightning protection device can reduce the influence of direct lightning strike, and the lightning protection device can release surge current to the earth.

06

Safety

If the building installed with external light protection device is far away from the inverter location, in order to protect the inverter from electrical and mechanical damage, the inverter should also install an external lightning protection equipment.

In order to protect DC system, two-stage surge protection equipment is needed between DC cable of inverter and photovoltaic equipment module.

In order to protect the AC system, the level 2 surge protection equipment should be installed at the AC output, located between the inverter and the grid. Installation requirements must comply with IEC61643-21 standard.

All DC cables shall be installed in a distance as short as possible, and the positive and negative cables of the same input need to be bundled together to avoid causing loops in the system. Minimum distance installation and binding requirements also apply to auxiliary grounding and shielding grounding conductors.

### ➤ Anti-islanding Effect

The islanding effect means that when the power grid is cut off, the grid-connected power generation system fails to detect the power outage and still supplies power to the power grid. This is very dangerous for the maintenance personnel and the power grid on the transmission line.

X3-Hybrid G4 series inverter's use active frequency offset method to prevent islanding effect.

### ➤ PE Connection and Leakage Current

• All inverters incorporate a certified internal Residual Current Monitoring (RCM) in order to protect against possible electrocution and fire hazard in case of a malfunction in the PV array, cables or inverter. There are 2 trip thresholds for the RCM as required for certification (IEC 62109-2:2011). The default value for electrocution protection is 30mA, and for slow rising current is 300mA.

• The inverter, with built-in RCM, will exclude possibility of DC residual current to 6mA, thus in the system an external RCD (type A) can be used ( $\geq 30mA$ ).

07







# Compliance Evaluation Report



REPORT No.: CSSC/BOS/012

ISSUED DATE: August 20, 2021

## APPENDIX C. X3-Hybrid Series User Manual 5.0kW – 15.0kW. (Cont.)

Safety

 **Warning!**  
**High leakage current!**  
**Earth connection essential before connecting supply.**

- A faulty ground connection can result in equipment failure, personal and death injuries, and electromagnetic interference.
- Ensure correct according to grounding to IEC62109 and conductor diameter according to STANDARD specification.
- Do not connect the grounding end of the equipment in series to prevent multi-point grounding.
- Electrical appliances must be installed in accordance with the wiring rules of each country.

#### For United Kingdom

- The installation that connects the equipment to the supply terminals shall comply with the requirements of BS 7671.
- Electrical installation of PV system shall comply with requirements of BS 7671 and IEC 60364-7-712.
- All protective devices cannot be changed.
- User shall ensure that equipment is so installed, designed and operated to maintain at all times compliance with the requirements of ESQCR22(1)(a).

#### ➤ Battery Safety Instructions

SolarX3-Hybrid G4 Series inverter should pair with high voltage battery for the specific parameters such as battery type, nominal voltage and nominal capacity etc, please refer to section 3.3.

Please refer to the matching battery specification for details.



08

Safety









### 1.3.2 Explanation of Symbols

This section gives an explanation of all the symbols shown on the inverter and on the type label.

#### • Symbols on the Inverter

Symbol	Explanation
	Operating Display
	Battery status
	An error has occurred, please inform your installer immediately

#### • Symbols on the Type Label

Symbol	Explanation
	CE mark: The inverter complies with the requirements of the applicable CE guidelines.
	TUV certified.
	RCM remark.
	SAA certification.
	Beware of hot surface: The inverter can become hot during operation. Avoid contact during operation.
	Danger of high voltages: Danger to life due to high voltages in the inverter!
	Danger: Risk of electric shock!
	Observe enclosed documentation.
	The inverter can not be disposed together with the household waste. Disposal information can be found in the enclosed documentation.

09



# Compliance Evaluation Report



REPORT No.: CSSC/BOS/012

ISSUED DATE: August 20, 2021

## APPENDIX C. X3-Hybrid Series User Manual 5.0kW – 15.0kW. (Cont.)

Installation

- Do not operate this Inverter until it is isolated from battery, mains and on-site PV generation suppliers.
- Danger to life due to high voltage.**  
There is residual voltage existing in the inverter after powering off, which needs 5 min to discharge.  
- Wait 5 min before you open the upper lid or the DC lid.

### 1.3.3 CE Directives

This chapter describes the requirements of the European low voltage regulations, including safety instructions and system licensing conditions, the user must comply with these regulations when installing, operating, and maintaining the inverter, otherwise it will cause personal injury or death, and the inverter will cause damage.

Please read the manual carefully when operating the inverter. If you do not understand 'danger', 'warning', 'caution' and the description in the manual, please contact the manufacturer or service agent before installing and operating the inverter.

Grid-connected inverter comply with low voltage directive (LVD) 2014/35/EU and Electromagnetic compatibility directive (EMC) 2014/53/EU. Detection of components is based on:  
EN 62109-1:2010;  
EN 62109-2:2011;  
IEC 62109-1(ed 1);  
IEC 62109-2(ed 1);  
EN 61000-6-3: 2007+A:2011;  
EN 61000-6-1: 2007;  
EN 61000-6-2: 2005;

For installation in photovoltaic module system, it is necessary to make sure that the whole system complies with the requirements of EC(2014/35/EU, 2014/53/EU, etc.) before starting the module (i.e. to start the operations). The assembly shall be installed in accordance with the statutory wiring rules. Install and configure the system in accordance with safety rules, including the use of specified wiring methods. The installation of the system can only be done by professional assemblers who are familiar with safety requirements and EMC. The assembler shall ensure that the system complies with the relevant national laws.

The individual subassembly of the system shall be interconnected by means of the wiring methods outlined in national/international such as the national electric code (NEPA) No. 70 or VDE regulation 0107.

10

Introduction

## 2 Introduction

### 2.1 Basic Features

X34 Hybrid G4 series is a high-quality inverter that can convert solar energy into alternating current and store energy into batteries. The inverter can be used to optimize self-consumption, stored in batteries for future use or fed into the public grid. The way it works depends on user preferences. It can provide emergency power during power outages.

### 2.2 Electrical Block Diagram of The System

X3-Hybrid G4 series has two wiring schemes, one is for M version inverter connected to X3-Matebox, and the other is for D version inverter.

There are different ways of wiring in different countries, one is to connect N line with PE line, the other is to separate the line from the PE line wiring, see below;

Diagram A: N line and PE line separate wiring, D version inverter; (for most countries)

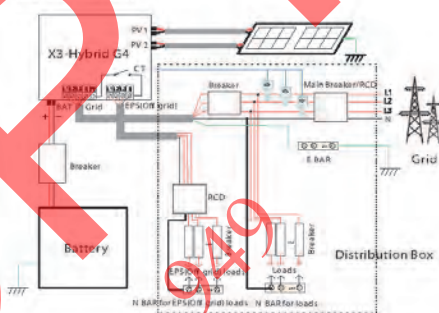

11

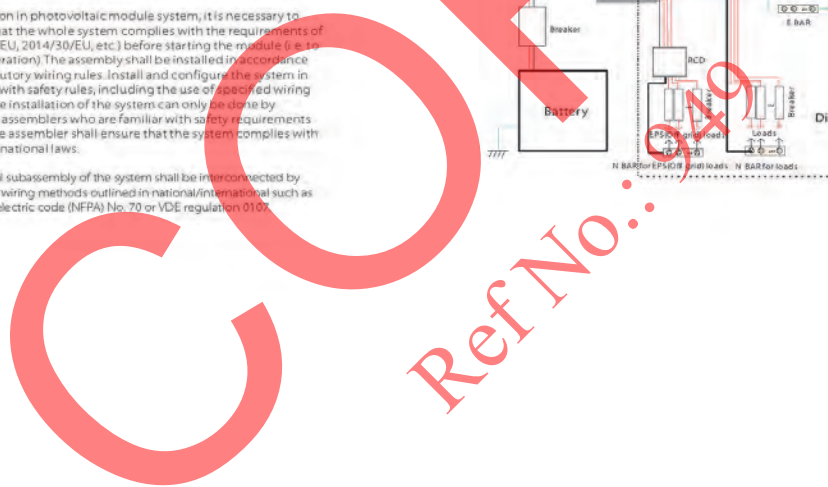



APPENDIX C. X3-Hybrid Series User Manual 5.0kW – 15.0kW. (Cont.)

Introduction

Introduction

Diagram B: N line and PE line separate wiring, M version inverter;  
(For most countries)

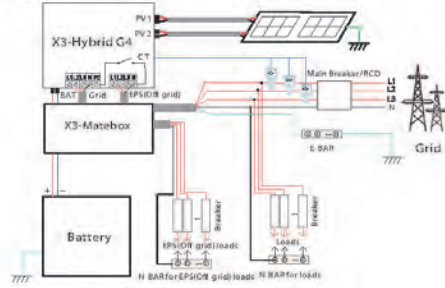

Diagram D: N line and PE line together, M version inverter;  
(Applicable to Australia)

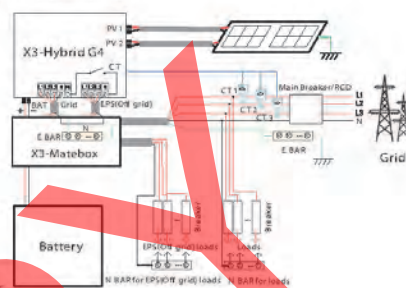
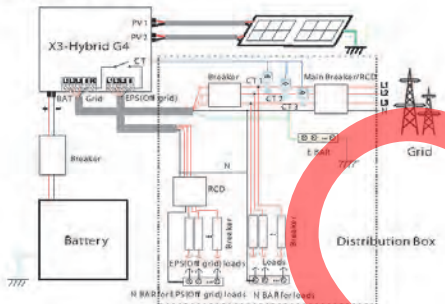

Diagram C: N line and PE line together, D version inverter;  
(Applicable to Australia)



**Note!**  
The RCD on the figure represents a leakage protection device with a circuit breaker function.

- When power cuts suddenly, the inverter connects the N line of EPS(Off-grid) load with the ground through relay, providing a fixed zero potential for EPS(Off-grid) load and ensuring the safety of electricity use by users.
- Please control the inverter load and make sure it is "output value" in "within" EPS(Off-grid) mode, otherwise the inverter will stop and alarm overload fault"
- Please confirm with the grid operator whether there are special regulations for grid connection.

12

13

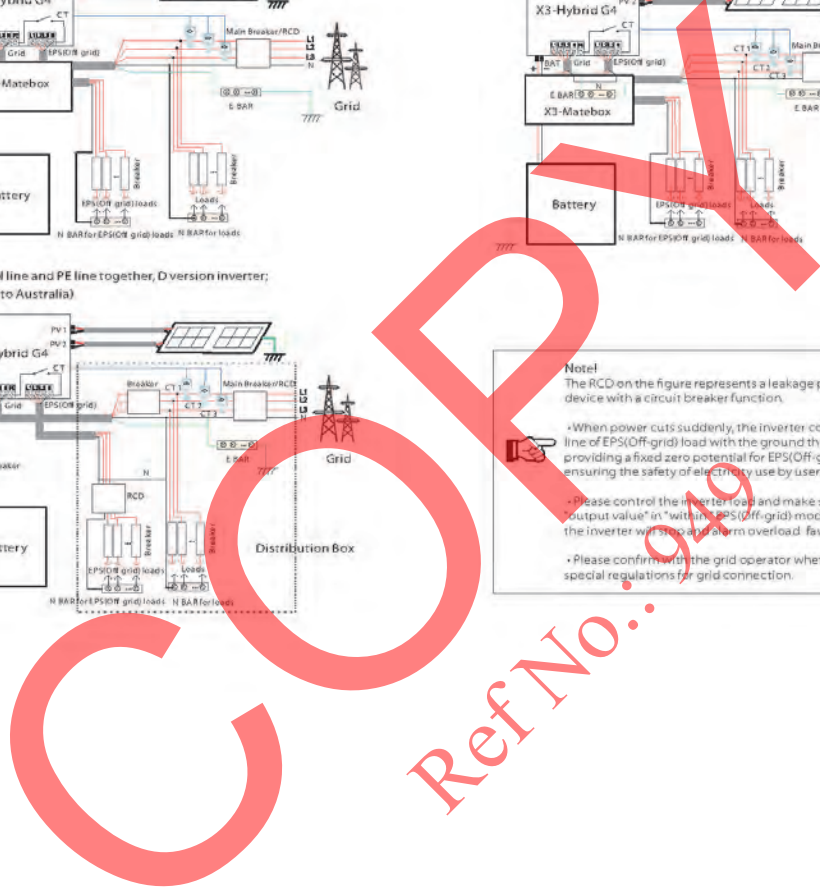



APPENDIX C. X3-Hybrid Series User Manual 5.0kW – 15.0kW. (Cont.)

Introduction

Introduction

2.3 Work Modes

X3-Hybrid G4 series, can be based on different needs, there are a variety of models:

Self Use

The self-use mode is suitable for areas with low feed-in subsidies and high electricity prices.

① When the power of PV is sufficient  
Active Charging or Discharge time period: PV will power the loads firstly, and surplus power will charge to the battery. If the battery is fully charged, then sell the surplus power to the grid. The inverter will limit the output if Feed-in limit or zero feed-in is needed.)

(PV > Load, PV → Load → Battery → Grid)

② When the power of PV is insufficient  
Active Charging time period: PV will power the loads firstly, the remaining power will be taken from the grid, the battery will not discharge at this time.

(PV < Load, PV + Grid → Load)

Active Discharge time period: PV+BAT will power the loads together, if the power is still not enough, the remaining power will be taken from the grid.

(PV < Load, PV + Battery → Grid → Load)

③ Without PV power  
Active Charging time period: The grid supplies the loads and also can charge the battery;

(PV=0, Grid → Load + Battery)  
Active Discharge time period: The battery will power the home loads firstly. If the battery power is not enough, the remaining power will be taken from the grid. The inverter will enter into the standby state.

(PV=0, Battery → Grid → Load)  
Battery min SOC can be set: 10%-100%.

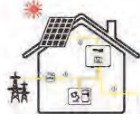
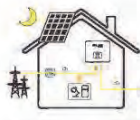

Feed-in priority

The Feed-in priority mode is suitable for areas with high feed-in subsidies, but has feed-in power limitation.

① When the power of PV is sufficient  
Active Charging time period: PV will power the loads firstly, and surplus power will feed-in to the grid. If the feed-in power has been limited, the surplus power can charge the battery.

(PV > Load, PV → Load → Battery → Grid → Battery)

Active Discharge time period: PV will power the loads firstly, and surplus power will feed-in to the grid.

(PV > Load, PV → Load → Grid)

② When the power of PV is insufficient  
Active Charging time period: PV will power the loads firstly, the remaining power will be taken from the grid. The battery will not discharge.

(PV < Load, PV + Grid → Load)

Discharge time period: PV+BAT will power the loads together. If the power is still not enough, the remaining power will be taken from the grid.

(PV < Load, PV + Battery + Grid → Load)



③ Without PV power  
Active Charging time period: The grid will power the home loads and also charge the battery;

(PV=0, Grid → Load + Battery)  
Active Discharge time period: The battery will power the home loads firstly. If the battery power is not enough, the remaining power will be taken from the grid. The inverter will enter into the standby state.

(PV=0, Battery → Grid → Load)

Battery min SOC can be set: 10%-100%.

Backup mode

The backup mode is suitable for areas with frequent power outages.

Same working logic with "Self-use" mode. This mode will maintain the battery capacity at a relatively high level, (Users' setting) to ensure that the emergency loads can be used when the grid is off. Customers no need to worry about the battery capacity.

Battery min SOC can be set: 30%-100%.

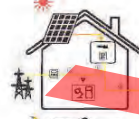

Backup mode SOC adjustment range: 30%-100%. In Backup mode, the EPS(Off-grid) SOC-min condition is adjustable within the range of 10%-25%.

EPS(Off-grid) mode

The EPS is used when the power grid is off. System will provides emergency power through PV and batteries to supply power to the household loads. (Battery must be installed for this mode)

① When the power of PV is sufficient  
PV will power the loads firstly, and surplus power will charge to the battery.

(PV > Load, PV → Load → Battery)

② When the power of PV is insufficient  
The remaining power will be taken from the battery.

(PV < Load, PV → Load → Battery)

③ Without PV power  
The battery will power the emergency loads until the battery reach the min SOC, then the inverter will enter into the idle mode.

(PV=0, Battery → Load)

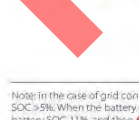

Note: In the case of grid connection, all working modes work normally when the battery SOC > 5%. When the battery charge rate is below 5%, the PV or Grid will first charge the battery SOC 11% and then turn to the working mode selected by the user.

14

15

Ref No.: 012





# Compliance Evaluation Report



REPORT No.: CSSC/BOS/012

ISSUED DATE: August 20, 2021

## APPENDIX C. X3-Hybrid Series User Manual 5.0kW – 15.0kW. (Cont.)

Introduction

Technical Data

### 2.4 Dimension



### 2.5 Terminals of Inverter

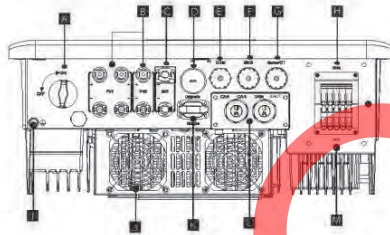

Object	Description
A	DC switch
B	PV connection port
C	Battery connection port
D	USB port for upgrading
E	Ethernet port
F	Battery communication
G	Meter/CT Port
H	Grid connection port
I	Ground connection port
J	Fan(only for X3-Hybrid-12.0 and X3-Hybrid-15.0)
K	External monitoring connection port
L	CAN are reserved ports / SHUT is a reserved port/ DRM Port(only for Australia)
M	EPS(Off-grid) Output(main load connection port)



**Warning!**  
Qualified electrician required for the installation.

## 3 Technical Data

### 3.1 DC Input

Model	X3-Hybrid-5.0	X3-Hybrid-5.0	X3-Hybrid-5.0	X3-Hybrid-5.0	X3-Hybrid-5.0	X3-Hybrid-5.0
Max. recommended DC power [W]	A:4000/B:4000	A:5000/B:5000	A:7000/B:5000	A:9000/B:5000	A:11000/B:7000	A:11000/B:7000
Max. DC voltage [V]	1000	1000	1000	1000	1000	1000
Nominal DC operating voltage [V]	640	640	640	640	640	640
Operating voltage typical [V]	180-950	180-950	180-950	180-950	180-950	180-950
Max. input current [A]	142/14	142/14	210/14	267/14	324/14	324/14
Max. short circuit current [A]	142/16	142/16	210/16	307/16	324/16	324/16
Start output voltage [V]	200	200	200	200	200	200
No. of MPPT trackers	2	2	2	2	2	2
Strings per MPPT tracker	1/1/1	1/1/1	1/1/1	1/1/1	1/1/1	1/1/1

16

17





# Compliance Evaluation Report



REPORT No.: CSSC/BOS/012

ISSUED DATE: August 20, 2021

## APPENDIX C. X3-Hybrid Series User Manual 5.0kW – 15.0kW. (Cont.)

Technical Data

### 3.2 AC Output/Input

Model	X3 Hybrid 5.0	X3 Hybrid 6.0	X3 Hybrid 8.0	X3 Hybrid 10.0	X3 Hybrid 12.0	X3 Hybrid 15.0
<b>AC Output</b>						
Nominal AC power [W]	5000	6000	8000	10000	12000	15000/16A 14000
Max apparent AC power [VA]	5500	6600	8800	11000	13200	15000
Rated AC voltage [V]	415/240, 400/230, 380/220					
Rated grid frequency [Hz]	50/60					
Max AC current [A]	8.1	9.7	12.9	16.1	19.3	24.1
Displacement power factor	1 (0.8 leading, 0.8 lagging)					
Total harmonic distortion (THD)	< 3%					
<b>AC Input</b>						
Rated AC power [W]	10000	12000	16000	20000	20000	20000
Rated grid voltage range [V]	415/240/400/230/380/220					
Rated grid frequency [Hz]	50/60					
Max AC current [A]	16.1	19.3	25.8	32.0	32.0	32.0

### 3.3 Battery

Model	X3 Hybrid 5.0	X3 Hybrid 6.0	X3 Hybrid 8.0	X3 Hybrid 10.0	X3 Hybrid 12.0	X3 Hybrid 15.0
Battery type	Lithium batteries					
Battery Full Voltage [V]	180 650					
Maximum charge/discharge flow [A]	30A					
Communication interface	CAN/RS485					
Reverse connection protection	Yes					

### 3.4 EPS(Off-grid) Output

Model	X3 Hybrid 5.0	X3 Hybrid 6.0	X3 Hybrid 8.0	X3 Hybrid 10.0	X3 Hybrid 12.0	X3 Hybrid 15.0
EPS(Off-grid) rated power [VA]	5000	6000	8000	10000	12000	15000
EPS(Off-grid) rated voltage [V]	400V/230VAC					
Frequency [Hz]	50/60					
EPS(Off-grid) rated current [A]	7.2	8.7	11.6	14.5	17.5	21.8
EPS(Off-grid) Peak Power [VA]	7500,605	9000,605	12000,605	15000,605	15000,605	16500,605
Switching time [s]	<1 0ms					
Total harmonic distortion (THD)	< 3%					

18

Technical Data

### 3.5 Efficiency, Safety and Protection

Model	X3 Hybrid 5.0	X3 Hybrid 6.0	X3 Hybrid 8.0	X3 Hybrid 10.0	X3 Hybrid 12.0	X3 Hybrid 15.0
MPPPT efficiency	99.9%	99.9%	99.9%	99.9%	99.9%	99.9%
European efficiency	97.7%	97.7%	97.7%	97.7%	97.7%	97.7%
Maximum efficiency	98.2%	98.2%	98.2%	98.2%	98.2%	98.2%
Max. battery charge efficiency (PV to BATT @ full load)	98.5%	98.5%	98.5%	98.5%	98.5%	98.5%
Max. battery discharge efficiency (BAT to AC) @ full load	97.5%	97.5%	97.5%	97.5%	97.5%	97.5%
<b>Safety &amp; Protection</b>						
DC SPD Protection						Integrated Type(I)
AC SPD Protection						Integrated Type(I)
Over/under voltage protection	YES					
Grid protection	YES					
OC Injection monitoring	YES					
Back-feed current monitoring	YES					
Residual current detection	YES					
Anti-islanding protection	YES					
Over load protection	YES					
Over temp protection	YES					
Anti insulation resistance detection	YES					

### 3.6 Generic Data

Model	X3 Hybrid 5.0	X3 Hybrid 6.0	X3 Hybrid 8.0	X3 Hybrid 10.0	X3 Hybrid 12.0	X3 Hybrid 15.0
Dimensions (W*H*D) [mm]	503*503*199					
Dimensions of Packing (W*H*D) [mm]	566*625*322					
Net weight [kg]	30	30	30	30	30	30
Gross weight [kg]	34	34	34	34	34	34
Heat dissipation treatment	Natural Cooling			Forced airflow		
Noise emission (typical) [dB]	<40					
Storage temperature range [°C]	-40~+70					
Operating temperature range [°C]	-35~+60 (derating at 45)					
Humidity (%)	≤100%					
Altitude [m]	≤1000					
Ingress Protection	IP65					
Protection Class	I					
Grid standby consumption	<1W					
Over voltage category	II (MAIN/SUPV; Battery)					
Insulation Degree	III					
Installation mode	Wall mounted					
Inverter Topology	Non-isolated					
Communication interface	Master / CT, external control RS485, Pocket series (optional), DRM, USB					

19





APPENDIX C. X3-Hybrid Series User Manual 5.0kW – 15.0kW. (Cont.)

Installation

Installation

4 Installation

4.1 Check for Transport Damage

Ensure that the inverter is in good condition via transportation. If there is any visible damage such as cracks, please contact the dealer immediately.

4.2 Packing List

Open the package and check the materials and accessories according to the following list.



Number	Quantity	Description
A	1	X3-Hybrid G4 series inverter.
B	1	Bracket
C*	1	Waterproof connector
D*	6	PV terminal (positive*3, negative*3)
E*	6	PV pin angle (positive*3, negative*3)
F*	12	10AWG European terminals
G*	1	OT terminal (inverter grounding)
H	5	(Expansion bolt, Gasket, Self-tapping bolt)
I	1	M5 inner hexagon bolt
J	3	Communication line adapter (COM/Meter/BMS)
K	2	Battery connection terminals (positive*1, negative*1)
L	5	RJ 45 terminals
M*	1	Manual
N	1	Quick Installation Guide
O	1	Warranty Card
P*	1	Pocket WiFi (optional)
Q	1	Meter (optional)
R	1	CT (optional)

Note: The M version inverter in the accessory package does not include the \*C\*/D\*/E\*/F\*/G\*/H\*/I\*/J\*/K\*/L\*/M\*/N\*/O\*/P\*/Q\*/R\* accessories. The M version inverter must be used with X3 Matebox. \*L\*: The inverter in Australia needs to be connected to DRM, which is 1 more communication line adapter than that in other countries.

20

21

COPIED Ref No.: 949





APPENDIX C. X3-Hybrid Series User Manual 5.0kW – 15.0kW. (Cont.)

Installation

Installation

### 4.3 Installation Precautions

The protection level of X3-Hybrid G4 series inverter is IP 65, so that the inverter can be installed outdoors. Check the installation environment and pay attention to the following conditions when installing:

- Do not expose to strong light.
- Do not touch flammable building materials.
- Do not approach flammable and explosive gases or liquids (e.g. where chemicals are stored).
- Do not touch cold air directly.
- Do not approach TV antenna or cable.
- Do not place in areas above 3000 meters above sea level.
- Do not install in precipitation or high humidity, which may cause corrosion or damage internal devices.
- Keep the system out of reach of children.

If the inverter is installed in a narrow area, be sure to reserve appropriate space for heat dissipation.

The ambient temperature of the installation site is -35°C~60°C. The maximum angle range of wall tilt is 5°. Avoid direct sunlight, rain and snow weather.

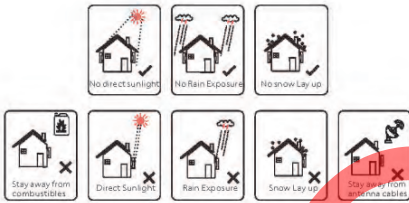

### 4.4 Tool preparation

Tool equipment					
Type	Name	Image	Name	Image	
Machine Installation Tools	Hammer drill		Multimeter		
	Torque screwdriver		Socket wrench set (Hexagon)		
	OT terminals press clamp		Diagonal pliers		
	Utility knife		Multifunction terminal crimping tool (RJ45)		
	wire stripper		Marker		
	Rubber hammer		Tape ruler		
	Crimping Tool		Hexagon keys		
	Euro terminal crimping tool		Spirit level		
	Individual Protection Tools	Dustproof Cover		Protective glasses	

22

23







# Compliance Evaluation Report



REPORT No.: CSSC/BOS/012

ISSUED DATE: August 20, 2021

## APPENDIX C. X3-Hybrid Series User Manual 5.0kW – 15.0kW. (Cont.)

Installation

Tool equipment				
Type	Name	Image	Name	Image
Individual Protection Tool	Safety gloves		Safety shoes	

Type	Name	Image	Requirement
Equipment Preparation	Breaker		Grid port and EPS(Off grid) port wiring section (4.5.2)
Cable Preparation	PV end wire		Dedicated PV wire, line number #12 AWG with stand voltage 1000V, temperature resistance 105°C fire resistance grade VW 1
	EPS(Off grid) end wire		Five core cable
	Grid end wire		Five core cable
	Communication lines		Twisted pair with shield
	Battery Cable		Conventional wire
	PE Cable		Conventional wire

24

Installation

### 4.5 Installation Site Conditions

#### 4.5.1 Installation Carrier Requirements

Do not install the inverter near flammable materials. Please install the inverter on a solid object that can withstand the weight requirements of the inverter and energy storage system. Please be careful not to install the inverter in the plasterboard wall or similar to the residential places with poor sound insulation, so as not to work with noise and interfere with the residents' life in the morning.

#### 4.5.2 Installation Requirements

Install the inverter at a maximum back tilt of 5 degrees; the inverter can not be tilted forward, inverted, excessive back tilted or side tilted.

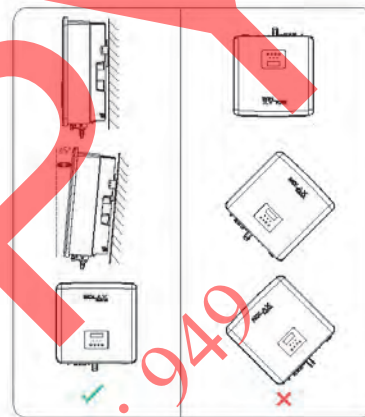

25





APPENDIX C. X3-Hybrid Series User Manual 5.0kW – 15.0kW. (Cont.)

Installation

4.5.3 Installation Space Requirements

Reserve enough space when installing inverter (at least 300mm) for heat dissipation

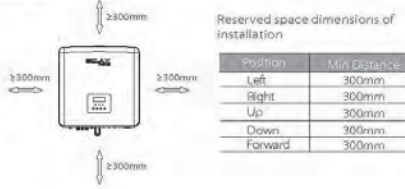

The distance of installation space for multiple inverter is as follows:

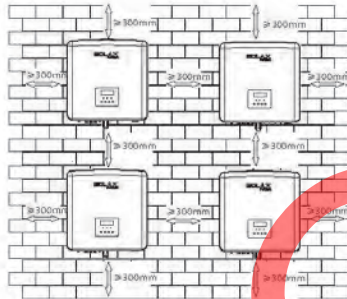

Installation

4.6 Mounting

► Preparation

Please prepare the following tools before installation.



Installation tools: screwdriver, wrench, 10/10 drill, hammer, socket wrench set and Hexagon keys.

► Step 1: Fix the wall bracket to the wall.

First find the expansion screw and the wall bracket in the accessory bag, as shown below.



a) Use a marker to mark drilling holes of the bracket on the wall. Drill holes at marked spots with depth of 65mm

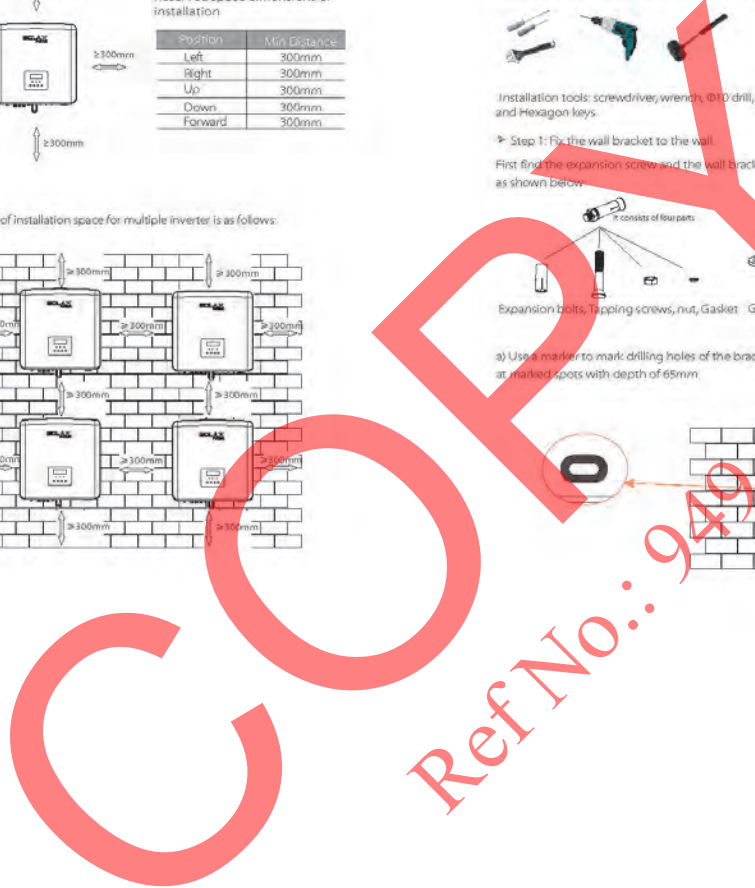
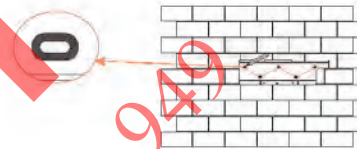



## APPENDIX C. X3-Hybrid Series User Manual 5.0kW – 15.0kW. (Cont.)

Installation

b) Hammer drill

➤ Step 2: hang the inverter on the bracket

c) Insert expansion bolt into the hole, use rubber hammer to knock the expansion screw bolt into the wall;

d) The bracket is aligned with the screw uses the inner hexagonal wrench to screw the tapping screw until the expansion bolt 'bang' is heard.

Expansion bolts, Tapping screws, Hammer (Torque:  $2.5 \pm 0.2 \text{ N}\cdot\text{m}$ )

nut, Gasket,

c) d)

28

Installation

➤ Step 3: Tighten the inverter and bracket

e) Hang the buckle on the inverter to the corresponding position of the backplane;

f) Use the inner hexagonal wrench to tighten the inner hexagonal screw on the right side of the inverter.

inner hexagonal wrench (Torque:  $1.5 \pm 0.1 \text{ N}\cdot\text{m}$ )

29

COPY

Ref No.: 949





APPENDIX C. X3-Hybrid Series User Manual 5.0kW – 15.0kW. (Cont.)

Electrical Connections

Electrical Connections

5 Electrical Connections

5.1 PV Connection

X3-Hybrid G4 series inverter have two PV inputs. Please select photovoltaic modules with good performance and quality assurance. The open circuit voltage of the module array should be less than the maximum PV input voltage specified by the inverter, and the working voltage should be within the MPPT voltage range.

Table 1: Maximum input voltage limit

Model	X3 Hybrid G0	X3 Hybrid G1	X3 Hybrid G2	X3 Hybrid G3	X3 Hybrid G4	X3 Hybrid G5
Max. DC input voltage	1000V					

**Warning!**  
The voltage of photovoltaic modules is very high, and is dangerous voltage. When wiring, please follow the safe electricity regulations.

**Note!**  
Please do not make PV positive or negative ground!

**Note!**  
The following PV module requirements need to be applied to each input range:  
1. Same model  
2. Same quantity  
3. The same queue  
4. The same angle

**Note!**  
X3-Hybrid G4 series inverters do not support the following PV module connection modes

**Note!**  
X3-Hybrid G4 series inverter support the following PV module connection modes

30

Connection step

The PV port wiring of X3 Hybrid G4 M version inverter has been completed. For specific installation details, please refer to the X3-Matebox Quick Installation Guide, the D version needs to be wired

Step 1. Turn off the DC switch, connect the PV module, prepare a 12AWG PV cable, and find the PV (+) terminal and PV (-) terminal in the package

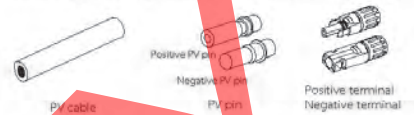

Step 2. Use a wire stripper to strip the 7mm insulation layer of the wire end.



Step 3. Tighten the cable with the insulation layer stripped and insert it into the metal terminal (see Figure 1), make sure all wires are inserted into the metal terminal (see Figure 2).

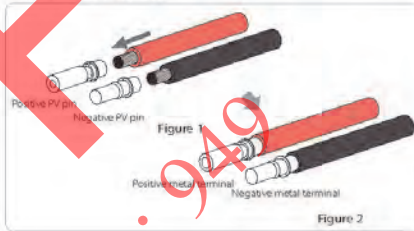

31

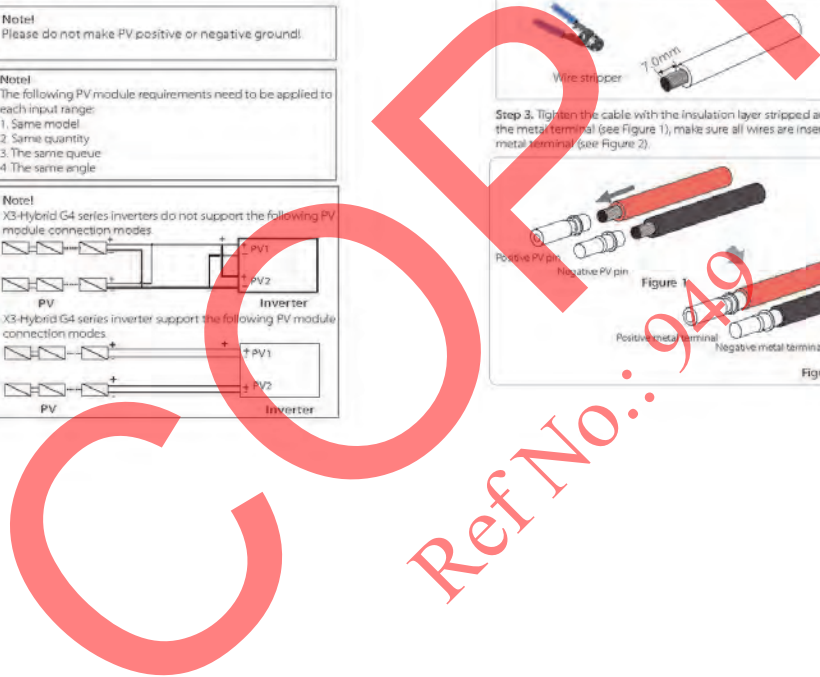



## APPENDIX C. X3-Hybrid Series User Manual 5.0kW – 15.0kW. (Cont.)

### Electrical Connections

Step 4. Tighten the PV pin needle and the wiring harness to make the connection tight without looseness

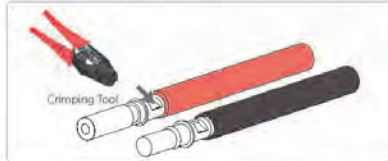

Step 5. The PV joint is divided into 2 parts—the plug and the fastening head. Insert the cable through the fastening head and the opposite plug. Note that the red and black lines correspond to different of plugs. Finally, force the cable pair into the plug, which will a "click" sound, which indicates that the connection is complete.



Step 6. Tighten the fastening head and into insert the corresponding positive and negative (PV-/PV+) ports of the inverter.



32

### Electrical Connections

The following is the location of the inverter's positive and negative (PV-/PV+) ports

Note: Before inserting the PV terminal, please turn on the switch of the PV module and use a multimeter to measure the positive and negative poles of the PV terminal port to prevent reverse connection.

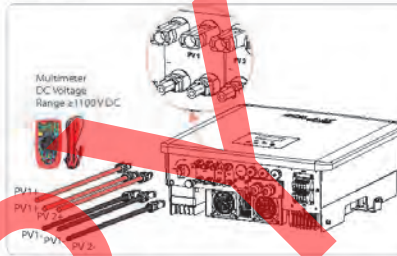

Schematic diagram of the inverter PV connected.

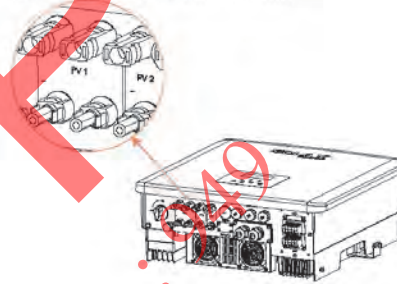

33

COPIES  
Ref No.: 20210820009





## APPENDIX C. X3-Hybrid Series User Manual 5.0kW – 15.0kW. (Cont.)

Electrical Connections

### 5.2 Grid Port and EPS(Off-grid) Output Connection

X3-Hybrid G4 series inverter are three-phase inverter. Suitable for rated voltage 380/400/415V, frequency 50/60Hz. Other technical requests should comply with the requirement of the local public grid.

#### > Grid port connection

##### Grid Cable and Micro-breaker recommended

Model	X3 Hybrid 50	X3 Hybrid 60	X3 Hybrid 80	X3 Hybrid 100	X3 Hybrid 120	X3 Hybrid 150
Cable (copper)	4-6mm <sup>2</sup>	4-6mm <sup>2</sup>	4-6mm <sup>2</sup>	5-6mm <sup>2</sup>	5-6mm <sup>2</sup>	5-6mm <sup>2</sup>
Micro-Breaker	20A	20A	32A	40A	40A	40A

##### EPS(Off-grid) Cable and Micro-breaker recommended

Model	X3 Hybrid 50	X3 Hybrid 60	X3 Hybrid 80	X3 Hybrid 100	X3 Hybrid 120	X3 Hybrid 150
Cable (copper)	4-6mm <sup>2</sup>	4-6mm <sup>2</sup>	4-6mm <sup>2</sup>	4-6mm <sup>2</sup>	4-6mm <sup>2</sup>	4-6mm <sup>2</sup>
Micro-Breaker	16A	16A	20A	25A	32A	40A

The load should not be directly connected to the inverter.



Figure: Wrong connection of load and inverter

34

Electrical Connections

### 5.3 EPS(Off-grid) Boick Diagram

X3-Hybrid G4 series inverter has an EPS(Off-grid) function. When the grid is connected, the inverter outputs go through the Grid port, and when the grid is disconnected, the inverter outputs go through the EPS(Off-grid) port.

The EPS(Off-grid) function can be connected to part of the load. Please refer to the following diagram for the wiring. If you want to save installation time, you will need an accessory. If you need a solution, please contact our sales staff.

#### > EPS(Off-grid) wiring diagram

For to different local wiring rules, please refer to the diagram below. Please select the appropriate wiring method according to local wiring rules.

##### Diagram A: N line and PE line separate wiring, D version inverters; (For most countries)

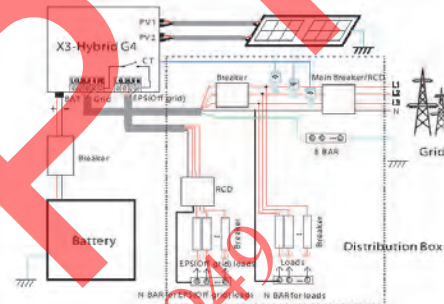

35



## APPENDIX C. X3-Hybrid Series User Manual 5.0kW – 15.0kW. (Cont.)

Electrical Connections

Diagram B: N line and PE line separate wiring, M version inverters;  
(For most countries)

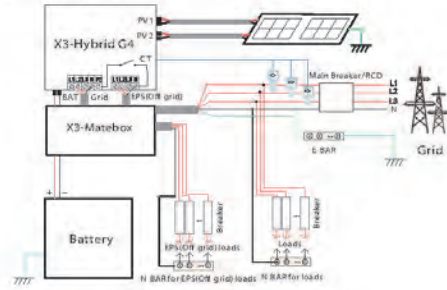
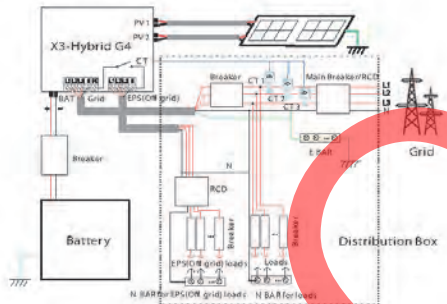
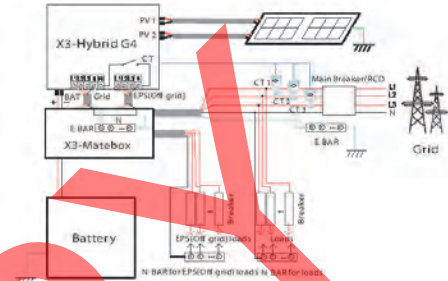

Diagram C: N line and PE line together, D version inverters;  
(Applicable to Australia)



Electrical Connections

Diagram D: N line and PE line together, all load connection EPS(OFF-grid)  
scheme;(Applicable to Australia)



X3-Matebox is a convenient wiring accessory. Please refer to X3-Matebox for details. If you need to purchase X3-Matebox, please contact us.

The RCD on the figure represents a leakage protection device with a circuit breaker function. To use X3-Matebox's Diagram B and Diagram D, you need to set "X3-Matebox" to "Enable" in "Settings". The Australian customer must shorten the N lines of the Grid and the EPS in the X3-Matebox. If your local wiring method does not follow the above operation guide, especially the neutral wire, ground wire, RCD wire, please contact your company before operation.



APPENDIX C. X3-Hybrid Series User Manual 5.0kW – 15.0kW. (Cont.)

Electrical Connections

Electrical Connections

➤ EPS(Off-grid) load requirements

**Warning!**  
Ensure that the EPS(Off-grid) load rated power is within the EPS(Off-grid) rated output power range, otherwise, the inverter will report an "overload" warning.

When "overload" occurs, adjust the load power to make sure it is within the EPS(Off-grid) rated output power range, and the inverter will automatically return to normal.

For non-linear loads, ensure that the inrush current power is within the EPS(Off-grid) rated output power range. When the configuration current is less than the maximum DC input current, the capacity and voltage of lithium and lead acid will decrease linearly.

The following table shows some common loads for your reference.

Note: Please check with the manufacturer for high-power inductive loads.

Content	Power		Common equipment	Equipment	Instance	
	Start	Rated			Start	Rated
Resistive load	x1	x1	Incandescent lamp	100W	100VA (W)	100VA (W)
Inductive load	x3~5	x2	Fan Fridge	150W	450-750VA (W)	300VA (W)

➤ Grid and EPS(Off-grid) connection

• Connection requirements

Note: Check the grid voltage and compare the voltage range (see technical data). Disconnect the circuit board from all power sources to prevent electric shock.

The Grid and the EPS(Off-grid) ports of X3-Hybrid G4 M version inverter have been connected, for specific installation details, please refer to the X3-Matebox Quick Installation Guide. And the D version needs to be wired according to the following steps.

**Step 1.** Prepare a Grid cable (five-core wire) and an EPS(Off-grid) cable (four-core wire), and then find the European terminal and waterproof cover in the accessory bag.

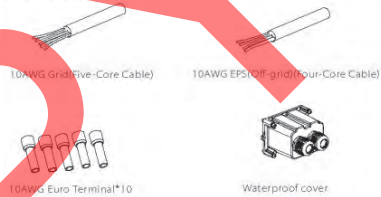

COPY Ref No.: 949







## APPENDIX C. X3-Hybrid Series User Manual 5.0kW – 15.0kW. (Cont.)

Electrical Connection

Step 2. First remove the waterproof housing plug, and then the Grid and EPS(Off-grid) cables through the waterproof housing corresponding to the Grid and EPS(Off-grid) ports.

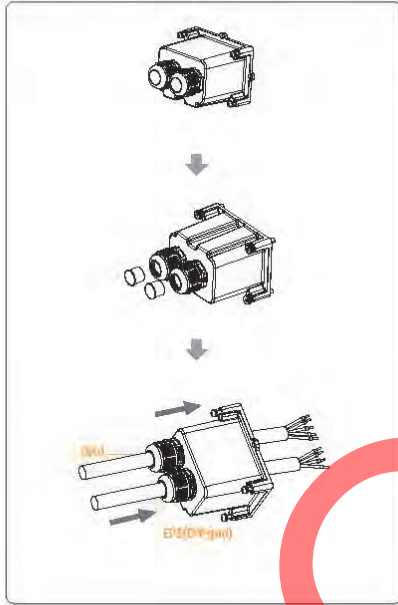

40

Electrical Connection

Step 3 Remove the 12mm insulation layer at the end of the wire. Insert the European-style terminals respectively, and make sure that the stripped ends are inserted into the European-style terminal, and finally use crimping pliers to press tightly.

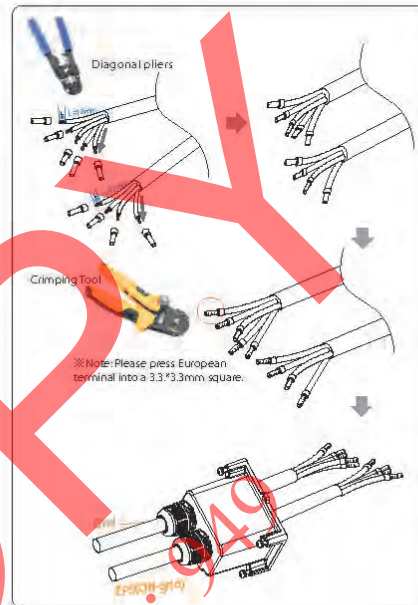

41

COPIED Ref No.: 049





APPENDIX C. X3-Hybrid Series User Manual 5.0kW – 15.0kW. (Cont.)

Electrical Connection

Step 4. Find the location of the AC interface on the inverter, insert the crimped terminals into the UW10 terminals L1, L2, L3, N, and PE according to the wire sequence, and use a flat-blade screwdriver to tighten the screws. (Torque: 0.2±0.1Nm)

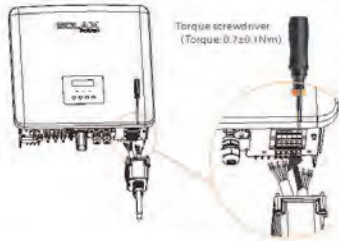

Step 5. Install the AC waterproof cover, and tighten the screws on the four sides of the waterproof cover with an Allen wrench.

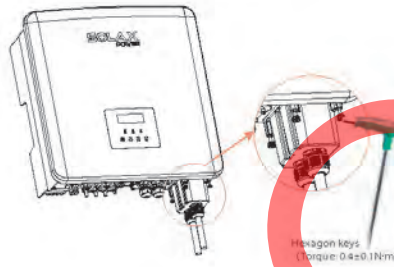

42

Electrical Connection

Step 6. Tighten the waterproof fastening head.

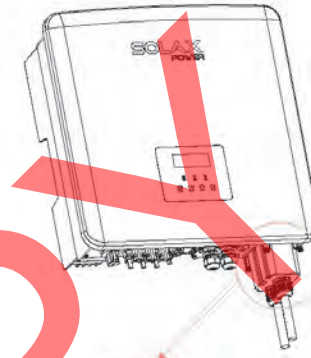

43

**COPY**  
RefNo.: 949





APPENDIX C. X3-Hybrid Series User Manual 5.0kW – 15.0kW. (Cont.)

Electrical Connection

5.4 Battery Connection

➤ Connection requirements

X3-Hybrid G4 series inverter charge and discharge system can be equipped with high voltage lithium battery.  
Please note that the maximum voltage of the battery should not exceed 650 V, battery communication should be compatible with the X3-Hybrid G4 inverter.

➤ Battery Breaker

Before connecting the battery, a non-polar DC MCB must be installed to ensure safety.  
Before maintenance, the inverter need to be safely disconnected.

Model	T3-Hybrid G4	S3-Hybrid G4	X3-Hybrid G4	X3-Hybrid G4	X3-Hybrid G4	X3-Hybrid G4
Voltage	Nominal voltage of DC breaker should be larger than maximum voltage of battery					
Current(A)	32A					

➤ Battery connection diagram

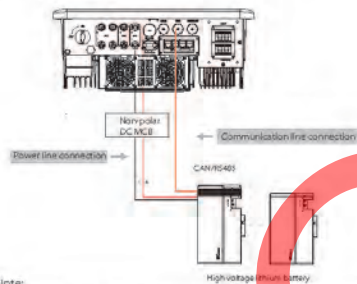

Note:  
When using SolaX battery, it is recommended to use the number of battery control (T-BAT-5.8) is 1, the number of battery modules (HV11550) is 2-4; the number of battery control (M0600) is 1, the number of battery modules (HV10220) is 2-4.

Electrical Connection

➤ Battery connection steps:

Battery port connection line of the X3-Hybrid G4-M version inverter is on the X3-Matebox, for specific installation details, please refer to the X3-Matebox Quick Installation Guide. It is necessary to wire the D version according to the following steps.

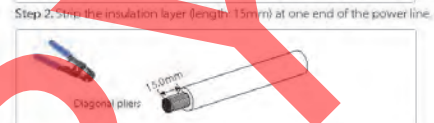
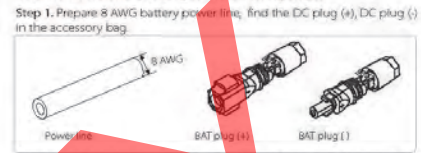

Step 3. Insert the stripped cables into the DC plug (-) and DC Plug (+) respectively.

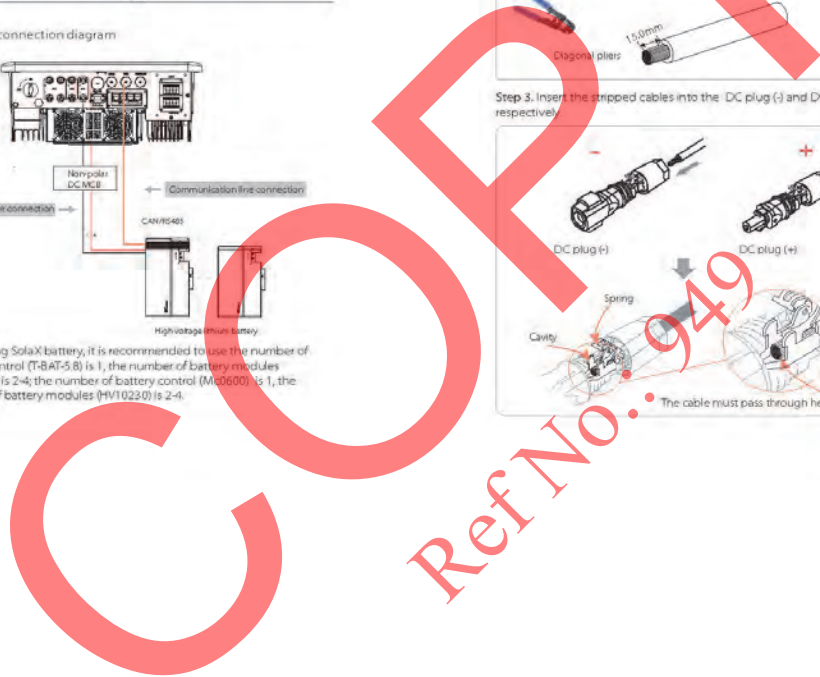
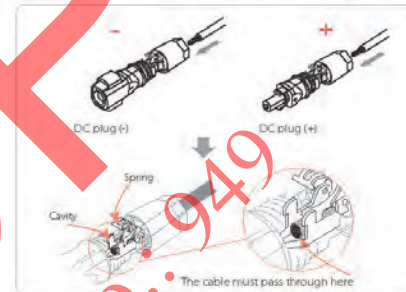



APPENDIX C. X3-Hybrid Series User Manual 5.0kW – 15.0kW. (Cont.)

Electrical Connection

Step 4. Press down on the spring by hand, you can hear a click sound, then push the ends together, and tighten the screw joints.

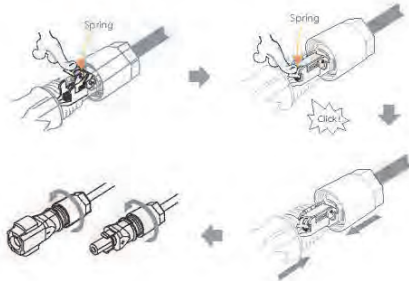

Step 5. Insert the battery power lines into the corresponding BAT port (+), (-) of the inverter.

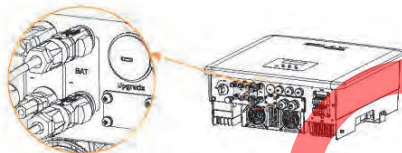

Note: BAT+ port, not PV+ port!  
Note: The positive and negative wires of the battery are not allowed to be reversed!

-46-

Electrical Connection

Communication connection

BMS port definition

The communication interface between the inverter and the battery uses the waterproof connector with RJ45.

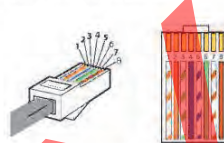

- 1) White with orange stripes
- 2) Orange
- 3) White with green stripes
- 4) Blue
- 5) White with blue stripes
- 6) Green
- 7) White with brown stripes
- 8) Brown

1	2	3	4	5	6	7	8
X	X	X	RED/WHITE	RED/BLACK	+	RED/BLACK	RED/WHITE

Note:  
After the BMS communication between the battery and the inverter is finished, the battery will work normally.

-47-

**COPY**  
Ref No.: 949





APPENDIX C. X3-Hybrid Series User Manual 5.0kW – 15.0kW. (Cont.)

Electrical Connection

Electrical Connection

5.5 Communication Connection

5.5.1 Introduction to DRM communication (AS4777 regulatory requirements)

DRM requirements:

Mode	Requirement
DRM0	Operation disconnect device
DRM1	Do not consume power
DRM2	Do not consume more than 50% of rated power
DRM3	Do not consume more than 75% of rated power AND Source reactive power if capable
DRM4	Increase power consumption (subject to constraints from other active DRMs)
DRM5	Do not generate power
DRM6	Do not generate more than 50% of rated power
DRM7	Do not generate more than 75% of rated power AND Sink reactive power if capable
DRM8	Increase power generation (subject to constraints from other active DRMs)

	1	2	3	4	5	6	7	8
	DRM1/5	DRM2/6	DRM3/7	DRM4/8	+3.3V	DRM0	GND	GND

Remarks:  
Currently only PIN6 (DRM0) and PIN1 (DRM1/5) are functional, other PIN functions are under development.

48

5.5.2 Introduction to meter/CT Communication

X3-Hybrid G4 inverter should work with an electric meter or current sensor (CT for short) to monitor household electricity usage. The electricity meter or CT can transmit the relevant electricity data to the inverter or platform, which is convenient for users to read at anytime.

Users can choose to use electric meters or CTs according to their needs. Please note that the meter/CT brand required by Solax must be used.

**Note!**  
The meter or CT must be connected to the inverter, otherwise the inverter will shut down and alarm Solax "meter failure" alarm. Smart meters must be authorized by Solax, third party or other companies. Unauthorized meter may be incompatible with the inverter.  
Solax will not be responsible for the impact caused by the use of other appliances.

Electric meter connection diagram

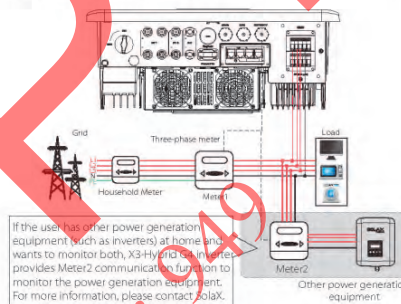

Note: If you want to connect the meter, please ground the GND terminal of the meter.

49





## APPENDIX C. X3-Hybrid Series User Manual 5.0kW – 15.0kW. (Cont.)

Electrical Connection

### > CT Connection

The current sensor measures the current on the live wire between the inverter and the public grid.

#### • CT connection diagram

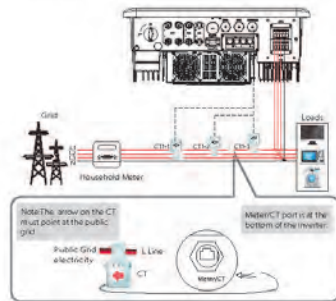

#### • LCD settings

To select CT, you need to enter Use setting, then enter CT/Meter Setting.

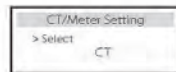

50

Electrical Connection

### • Note for CT connection:

**Note!**

- Do not place the CT on the N wire or ground wire.
- Do not put CT on the N line and L line at the same time.
- Do not place the CT on the side where the arrow points to the inverter.
- Do not place the CT on non-insulated wires.
- The cable length between CT and inverter should not exceed 25 meters.
- After CT is connected, prevent the CT clip from falling off. It is recommended to wrap the CT clip around in circles with insulating tape.



**Note!**

Only one of the Meter and CT connections can be selected. Meter cable goes to pin terminal 4 and 5; CT1 cable to PIN Terminal 4 and 5; CT2 cable to PIN Terminal 1 and 8; CT3 cable is connected to terminals 3 and 6.

51





## APPENDIX C. X3-Hybrid Series User Manual 5.0kW – 15.0kW. (Cont.)

### Electrical Connection

#### 5.5.3 COM Communication

COM communication interface is mainly provided to the customer to do the second step of development use. Use communication to control external equipment or external equipment to control the use of the inverter.  
For example: the inverter adjusts the working mode of the heat pump and so on.

#### Application occasion

COM is a standard communication interface, through which the monitoring data of the inverter can be directly obtained. Also, external communication devices can be connected to carry out the secondary development of the inverter. For specific technical docking, please contact SolarX.

#### External communication equipment controls the inverter:

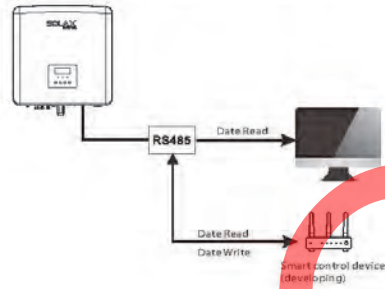

52

### Electrical Connection

#### Inverter communication control external equipment:

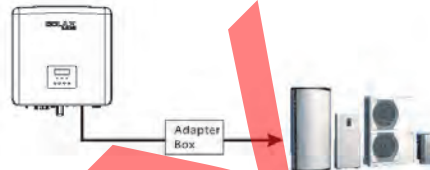

#### COM PIN Definition

	1	2	3	4	5	6	7	8
Pin	Dynastat	485A	Dynastat	+13V	485B	485B	GND	Dynastat
Read								

**Note!**  
The communication port on COM must be consistent with the definitions of pins 1, 2, 3, 4, 5, 6, 7, and 8 above; the connection PIN angle of the inverter is 4, 5 for the external communication equipment, and the inverter communication controls the external equipment. The pin angles are 3, 6, 7, and 8. For example, the pin angles of the inverter communication control heat pump dry contact are 3, 6, 7, and 8.

53

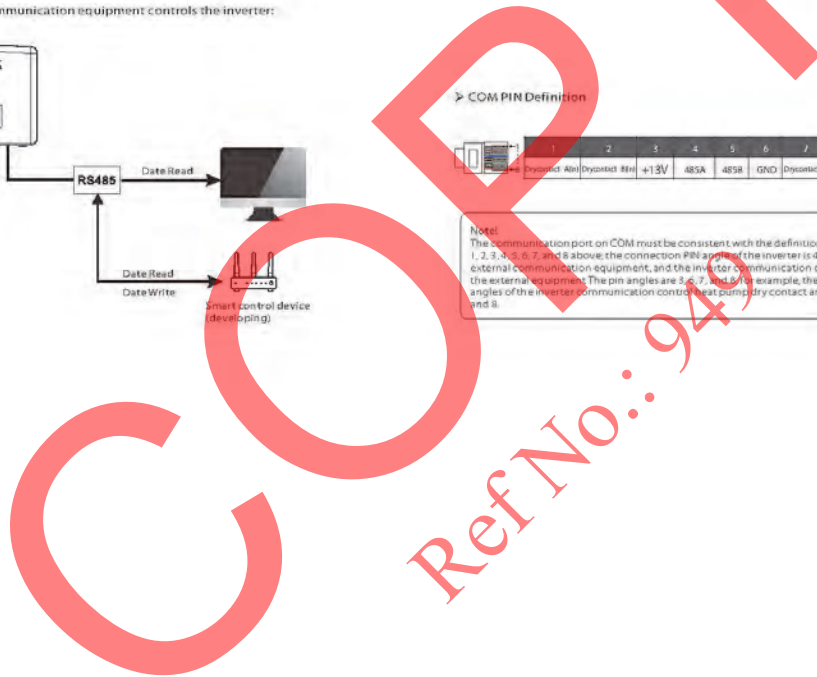



APPENDIX C. X3-Hybrid Series User Manual 5.0kW – 15.0kW. (Cont.)

Electrical Connection

5.5.4 Communication Connection Steps

Step 1. Prepare a communication cable, and then find the communication adapter in the accessory bag.



Step 2. The inverter CAN/DRM/SHUT port communication line connection, need to remove the inverter cover plate.

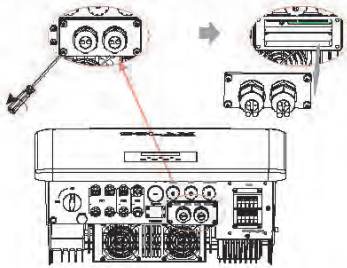

Step 3. Insert the communication cable through the communication adapter, and peel off the outer insulation layer of 15 mm.

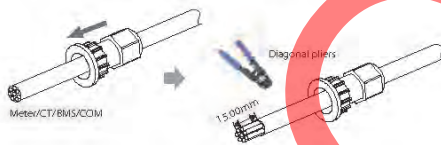

54

Electrical Connection

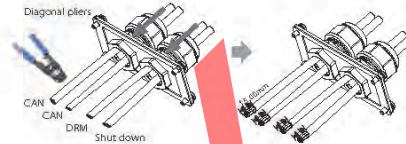

Step 4. Insert the prepared communication cables into the RJ45 terminals in sequence, and then use network cable crimping pliers to press them tightly.

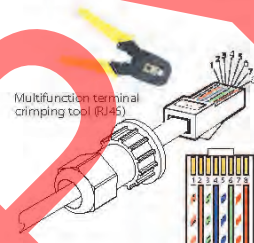

- 1) White with orange stripes
- 2) Orange
- 3) White with green stripes
- 4) Blue
- 5) White with blue stripes
- 6) Green
- 7) White with brown stripes
- 8) Brown

55

COPIED Ref No.: 949







APPENDIX C. X3-Hybrid Series User Manual 5.0kW – 15.0kW. (Cont.)

Electrical Connection

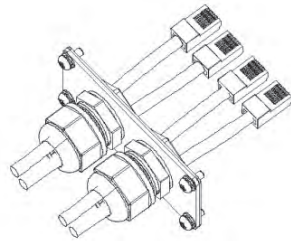

➤ BMS communication cable.

The BMS pin is defined as follows:



**Note!**  
The communication port on the lithium battery must be consistent with the definition of pins 4, 5, 7, and 8 above:

56

Electrical Connection

➤ DRM communication cable

The DRM pin is defined as follows:



**Note!**  
At present, there are only PIN6 (DRM0) and PIN1 (DRM1 / 5), and other PIN functions are under development.

57





## APPENDIX C. X3-Hybrid Series User Manual 5.0kW – 15.0kW. (Cont.)

### Electrical Connection

- METER/CT communication cable
- METER/CT pin is defined as follow:



**Note!**  
Only one of the Meter and CT connections can be selected. Meter cable goes to pin terminal 4 and 5; CT1 cable to PIN Terminal 4 and 5; CT2 cable to PIN Terminal 1 and 8; CT3 cable is connected to terminals 3 and 6.

- 1) Users can customize the length of the CT communication cable. The accessory package provides 1\* RJ45 and 1\* waterproof connector with RJ45 terminals. When the CT cable is completed, connect the A terminal to the 'CT/METER' port of the inverter and tighten the waterproof screw, and connect the B terminal to the RJ45 coupler.



58

### Electrical Connection

- 2) One side of the finished cable, Waterproof connector with RJ45 is inserted into the inverter, and one side of the RJ45 terminal is inserted into the CT connection.

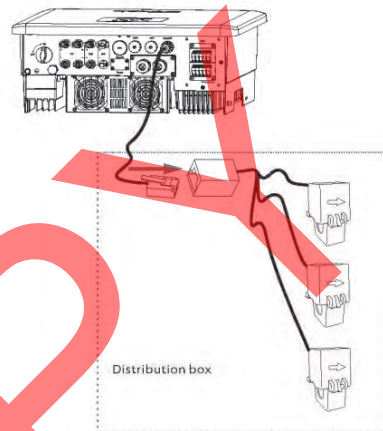

**Note!**  
When installing, pay attention to water resistance. All the connected parts of CT must be put into the distribution cabinet.

59



# Compliance Evaluation Report



REPORT No.: CSSC/BOS/012

ISSUED DATE: August 20, 2021

## APPENDIX C. X3-Hybrid Series User Manual 5.0kW – 15.0kW. (Cont.)

Electrical Connection

Step 5. Connect the DRM / CAN / SHUT communication cable, and insert the cable into the corresponding port.

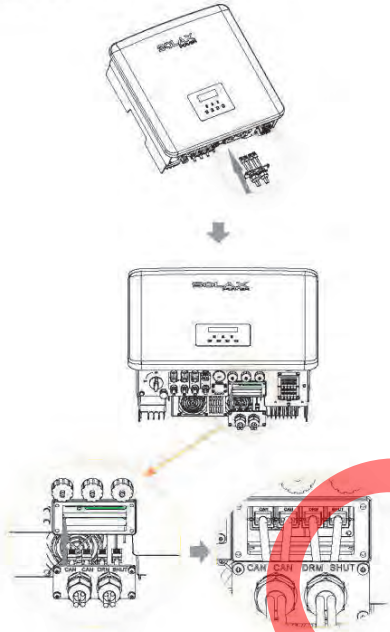

60

Electrical Connection

Step 6. Lock the cover plate and tighten the fastening head.

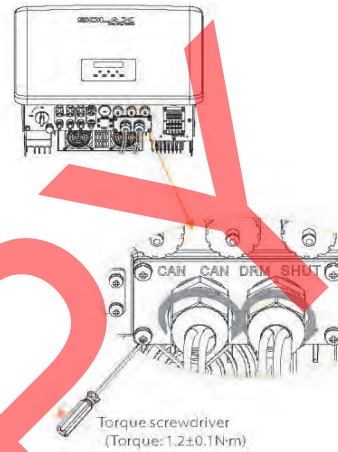

61

**COPI**  
RefNo.: 949





## APPENDIX C. X3-Hybrid Series User Manual 5.0kW – 15.0kW. (Cont.)

Electrical Connection

Step 7: Finally, find the corresponding COM, BMS, Meter, CT, CAN, DRM, SHUT points on the inverter and insert the communication cable into the corresponding ports

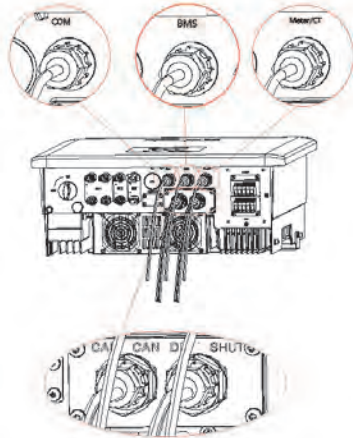

62

Electrical Connection

### 5.6 Grounding Connection (mandatory)

The user must make two ground connections: one shell grounding, and one equipotential grounding. This prevents electric shock.

Notes: If the PV end of the inverter is not connected with earth, the inverter will turn on a red light. Inspect and report ISO Fault. This inverter complies with IEC 62109-2 clause 13.9 for earth fault alarm monitoring.

Ground wire port of X3-Hybrid G4 M version inverter has been connected, and the D version needs to be wired according to the following steps.

#### Ground connection steps:

Step 1. Prepare a one-core cable (12AWG), and then find the ground terminal in the accessories



Step 2. Strip the grounding cable insulation (length L2), insert the striped cable into the ring terminal, and then clamp it.



63





# Compliance Evaluation Report



REPORT No.: CSSC/BOS/012

ISSUED DATE: August 20, 2021

APPENDIX C. X3-Hybrid Series User Manual 5.0kW – 15.0kW. (Cont.)

Electrical Connection

Step 3. Insert the striped cable into OT terminal and tighten the terminal with a terminal crimping tool

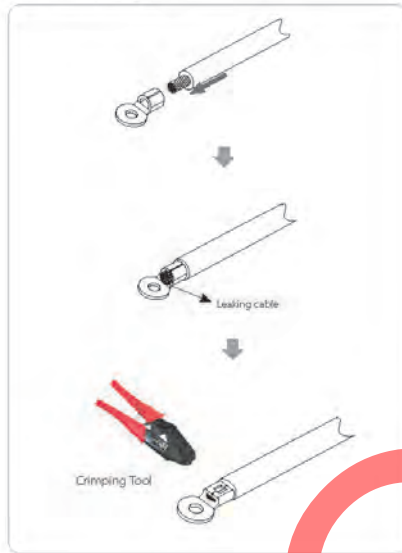

64

Electrical Connection

Step 4. Find the ground connection port on the inverter, and screw the ground wire on the inverter with an M5 Allen key

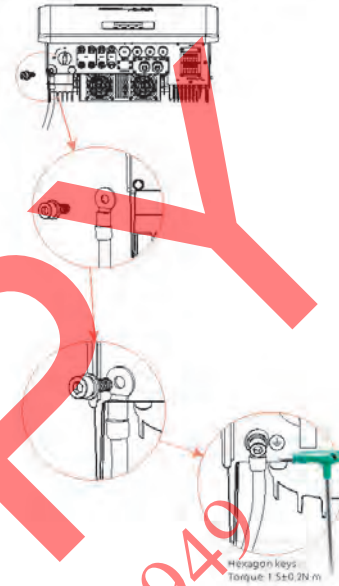

65

COPY RefNo.: 949





## APPENDIX C. X3-Hybrid Series User Manual 5.0kW – 15.0kW. (Cont.)

Electrical Connection

Electrical Connection

### 5.7 Monitoring Connection (Accessories)

The inverter provides a DONGLE port, which can transmit data of the inverter to the monitoring website via Pocket WiFi Plus, Pocket 4G, Pocket GPRS, and Pocket LAN. (If necessary, purchase products from SolisX)

➤ DONGLE connection diagram

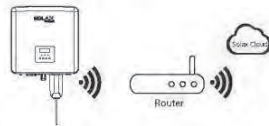

➤ Wireless monitoring accessories connection steps:

DONGLE port connection line of the X3-Hybrid G4M version inverter is on the X3-Matebox, for specific installation details, please refer to the X3-Matebox Quick Installation Guide. It is necessary to wire the D version according to the following steps.

Step 1. Of the DONGLE port of the Inverter needs to unscrew the screw and take off the cover.

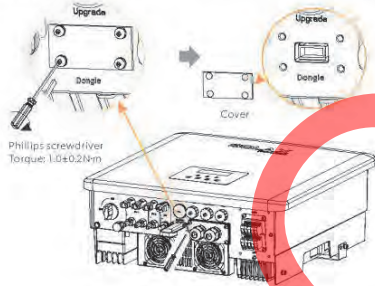

Step 2. Plug the Pocket WiFi Plus into the DONGLE port, use the screws in the Pocket WiFi Plus accessory to tighten it.

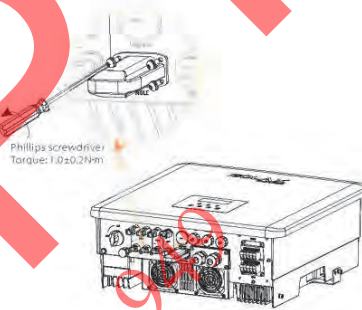
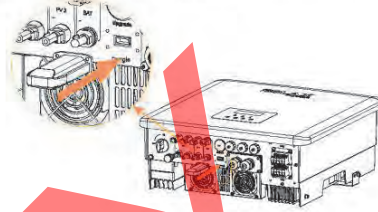

66

67

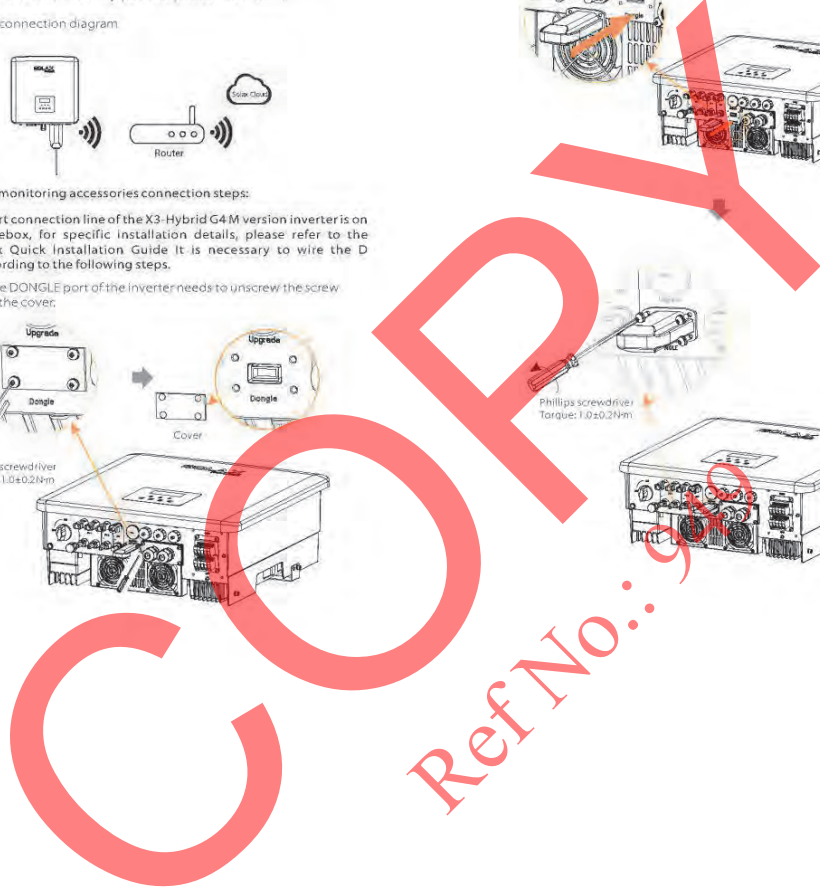



## APPENDIX C. X3-Hybrid Series User Manual 5.0kW – 15.0kW. (Cont.)

Electrical Connection

### 5.8 Check All Below Steps Before Starting Inverter

➤ After the inverter is checked, the conduct the following steps:

- ❶ Make sure that the inverter is fixed on the wall.
- ❷ Ensure that all ground wires are grounded.
- ❸ Confirm that all DC lines and AC lines are connected.
- ❹ Make sure the CT are connected.
- ❺ Make sure the battery is well connected.
- ❻ Turn on the Load switch and EPS(Off-grid) switch.
- ❼ Turn on the battery switch.

Long press the "Enter" key for 5 seconds to exit the Off mode.  
(The mode is factory defaulted as Off Mode)

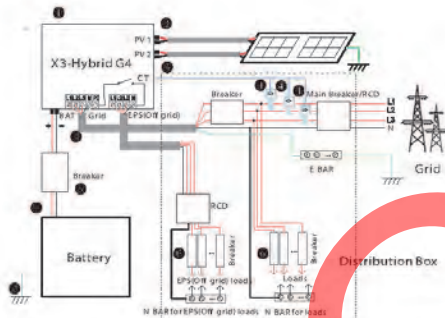

Note: The RCD on the figure represents a leakage protection device with a circuit breaker function.

68

Electrical Connection

### 5.9 Inverter Operation

➤ Before operation, check the inverter according to the following steps:

- a) Check that the inverter is well fixed on the wall.
- b) Ensure that all ground wires are well tightened.
- c) Ensure that all DC and AC circuit breakers are disconnected.
- d) Ensure that all ground wires are well tightened.
- e) The AC output terminal is correctly connected to the mains.
- f) Ensure that all photovoltaic panels and inverters are properly connected. Unused DC connectors should be blocked with caps.

➤ Start the inverter

- Steps to start the inverter
  - Turn on the AC switch between the X3-Hybrid G4 and the power grid.
  - (Optional) Remove the locking screw from the DC switch.
  - Turn on the DC switch between the PV string and the X3-Hybrid G4 if there is any.
  - Turn on the DC switch at the bottom of the X3-Hybrid G4.
- When the photovoltaic panel generates enough power, the inverter will start automatically.
  - If the battery port of the X3-Hybrid G4 is connected to a battery, turn on the auxiliary power switch of the battery and then the battery switch.
- Check the status of the LED and LCD screen, the LED is blue, and the LCD displays the main interface.
  - If the LED is not blue, please check the following:
    - All connections are correct.
    - All external disconnect switches are closed.
    - The DC switch of the inverter is set to the "ON" position.

The following are 3 different states of inverter operation, which means that the inverter starts successfully.

Warning: When the DC output voltage of the photovoltaic panel is higher than 140V (lowest starting voltage) and lower than 150V (lowest working voltage), the inverter waits for checking.

Checking: The inverter will automatically detect the DC input. When the DC input voltage of the photovoltaic panel is higher than 200V and the photovoltaic panel has enough energy to start the inverter, the inverter will enter the checking state.

69



## APPENDIX C. X3-Hybrid Series User Manual 5.0kW – 15.0kW. (Cont.)

### Electrical Connection

Normal: When the inverter is working normally, the green light is always on. At the same time, the power is fed back to the grid, and the LCD displays the output power.

If it is the first time to boot, please follow the prompts to enter the setting interface.

**Warning!**  
The input terminal of the inverter can be opened only when all the installation work of the inverter has been completed. All electrical connections must be performed by professionals in accordance with local regulations.

**Note!**  
If it is the first time to operate the inverter, the system will automatically display setup guide. Please follow the setup guide to complete the basic inverter settings.

70

### Firmware Upgrading

#### 6 Firmware Upgrade

##### ➤ Upgrade notes

Please read the following precautions before upgrading.



**Warning!**  
- In order to upgrade the firmware smoothly, if the DSP and ARM firmware need to be upgraded, please note that ARM firmware must be upgraded first, then DSP firmware!  
- Please make sure that the category format is correct, do not modify the firmware file name. Otherwise, the inverter may not work!



**Warning!**  
- For X3-Hybrid G4, ensure that the PV input voltage is greater than 180V (upgrade on sunny days), please ensure that the battery SOC is greater than 20% or the battery input voltage is greater than 180V. Otherwise, it may cause serious failure during the upgrade process!



**Caution!**  
- If the ARM firmware upgrade fails or stops, please do not unplug the U disk power off the inverter and restart it. Then repeat the upgrade steps.



**Caution!**  
- If the DSP firmware upgrade fails or stops, please check whether the power is off. If it is normal, plug in the U disk again and repeat the upgrade.

##### ➤ Upgrade preparation

1) Please check the inverter version and prepare a U disk (USB 2.0/3.0) and personal computer before upgrading.



**Caution!**  
- Please make sure that the size of the U disk is smaller than 32G, and the format is FAT 16 or FAT 32.

71







## APPENDIX C. X3-Hybrid Series User Manual 5.0kW – 15.0kW. (Cont.)

### Firmware Upgrading

2) Please contact our service support through [service@solaxpower.com](mailto:service@solaxpower.com) to obtain the firmware, and store the firmware in the U disk according to the following path.

Update:  
For ARM file: \update\ARM\618.00406.00\_Hybrid\_X3G4\_ARM\_V1.01.0710.usb';  
For DSP file: \update\DSP\618.00405.00\_Hybrid\_X3G4\_DSP\_V1.01.0710.hex';

#### ➤ Upgrade steps

Step 1. Please save the 'Upgrade' firmware in your U disk first, and press the 'Enter' button on the inverter screen for 5 seconds to enter the OFF mode.



Step 2. Find the 'update' port of the inverter, use a flat-blade screwdriver or coin with the same width to remove the waterproof cover, and insert the U disk.

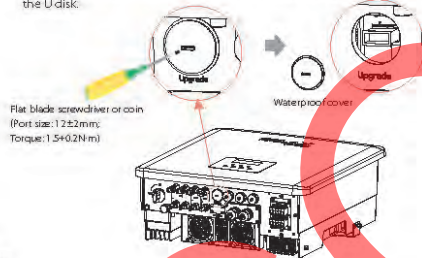

Flat blade screwdriver or coin  
(Port size: 1.7±2mm;  
Torque: 1.5±0.2N·m)

72

### Firmware Upgrading

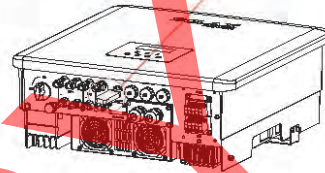

Step 3. LCD operation, enter the upgrade interface 'update', as shown below(a); Please press the up and down keys to select ARM, then press down to set 'OK'; press the enter key to enter the software version interface;

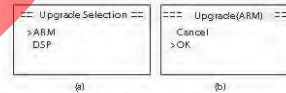

Step 4. Please confirm the new firmware version again and select the firmware to upgrade. The upgrade takes about 20 seconds.  
(d) When it is completed, the LCD screen returns to the 'Update' page.

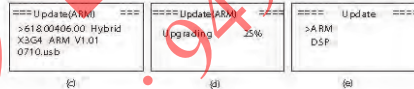

73



APPENDIX C. X3-Hybrid Series User Manual 5.0kW – 15.0kW. (Cont.)

Firmware Upgrading

**Step 5.** For DSP: Please wait for 10 seconds. When "Update" page shown as below, press down to select "DSP" and then press Enter. Please confirm the firmware version again and press Enter to upgrade. The upgrade takes about 2 minutes.

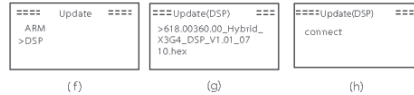

**Step 6.** After the upgrade is completed, the LCD screen displays "Upgrade Successful".



**Step 7.** Plug off the U disk, press "Esc" to return to the main interface, and long press the enter key to exit the mode.

**Caution!**

- Please strictly follow each step from step 1-6, don't miss it.
- Please confirm the ARM/DSP firmware version on the USB flash drive.

**Tip:** If the display screen is stuck on "X3-Hybrid G4" after the upgrade, please turn off the photovoltaic power supply and restart, and the inverter will restart and return to normal. If not, please contact our service @solaxpower.com for help.

74

Setting

## 7 Setting

### 7.1 Control Panel

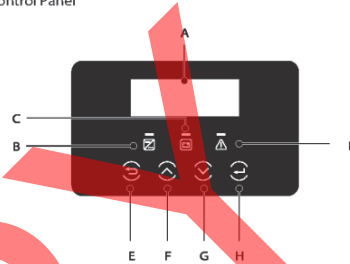

Object	Name	Description
A	LCD Screen	Display inverter information on the LCD display.
B	Blue light	Blue light: The inverter is in normal state or EPS(Off-grid) mode. Blue flashing: The inverter is in the waiting, checking state or the system switch is off. Off: The inverter is in a fault state.
C	LED Indicator light	Green: The battery communication is normal but the battery MCB is disconnected, and the battery communication is normal and working normally. Green flashing: The battery communication is normal and in an idle state. Off: The battery does not communicate with the inverter.
D	Red light	Red light on: The inverter is in a fault state. Off: The inverter has no error.
E	ESC button	ESC button: Return from the current interface or function.
F	Up button	Up button: Move the cursor to the upper part or increase the value.
G	Down button	Down button: Move the cursor down or decrease the value.
H	Enter button	Enter button: Confirm selection.

75





## APPENDIX C. X3-Hybrid Series User Manual 5.0kW – 15.0kW. (Cont.)

Setting

Setting

### 7.2 Screen Menu Structure

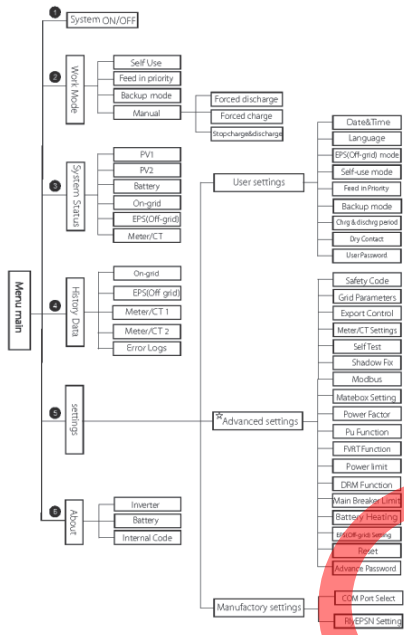

Note: "A" This part of the content cannot be set by the end user. Please contact the installer or Solax if necessary.

### 7.3 LCD Operation

The main interface is the default interface, the inverter will automatically return to this interface when the system started up successfully or not operated for a period of time.

The information of the interface is as below. "Power" means the instant output power; "Today" means the power generated within the day. "Battery" means the left capacity of battery energy.

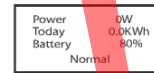

#### > Menu interface

The menu interface is another interface for users to change settings or obtain information.

- When the LCD displays the main interface, click "OK" to enter this interface.
- The user can select up and down the menu, and press the "OK" key to confirm.

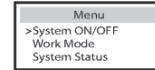

Ref No.: 949





APPENDIX C. X3-Hybrid Series User Manual 5.0kW – 15.0kW. (Cont.)

Setting

Setting

➤ Menu main

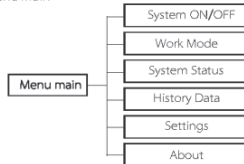

➤ System ON/OFF

\*ON\* means the inverter is in working state, and the inverter is in the default state.  
 \*OFF\* means that the inverter stops running and only the LCD screen is on.

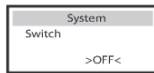

➤ Mode Selection



Mode selection, there are 4 working modes to choose from.

Name	Description
Self Use	The self-use mode is suitable for areas with low feed-in subsidies and high electricity prices. ① When the power of PV is sufficient Active Charging or Discharge time period: PV will power the loads firstly, and surplus power will charge to the battery, if the battery is fully charged, then sell the surplus power to the grid; (The inverter will limit the output if feed-in limit or zero feed-in is needed.) (PV > Load, PV → Load → Battery → Grid) ② When the power of PV is insufficient Active Discharge time period: PV will power the loads firstly, the remaining power will be taken from the grid, the battery will not discharge at this time. (PV < Load, PV + Grid → Load) Active Discharge time period: PV+BAT will power the loads together. If the power is still not enough, the remaining power will be taken from the grid. (PV < Load, PV + Battery + Grid → Load) ③ Without PV power Active Charging time period: The grid supplies the loads and also can charge the battery. (PV=0, Grid → Load + Battery) Active Discharge time period: The battery will power the home loads firstly, if the battery power is not enough, the remaining power will be taken from the grid. The inverter will enter into the standby state. (PV=0, Battery+Grid → Load) Battery min SOC can be set: 10%-100%
Feed-in priority	The Feed-in priority mode is suitable for areas with high feed-in subsidies, but has feed-in power limitation. ① When the power of PV is sufficient Active Charging time period: PV will power the loads firstly, and surplus power will feed-in to the grid, if the feed-in power has been limited, the surplus power can charge the battery. (PV > Load, PV → Load → Grid → Battery) Active Discharge time period: PV will power the loads firstly, and surplus power will feed-in to the grid. (PV < Load, PV → Load → Grid)

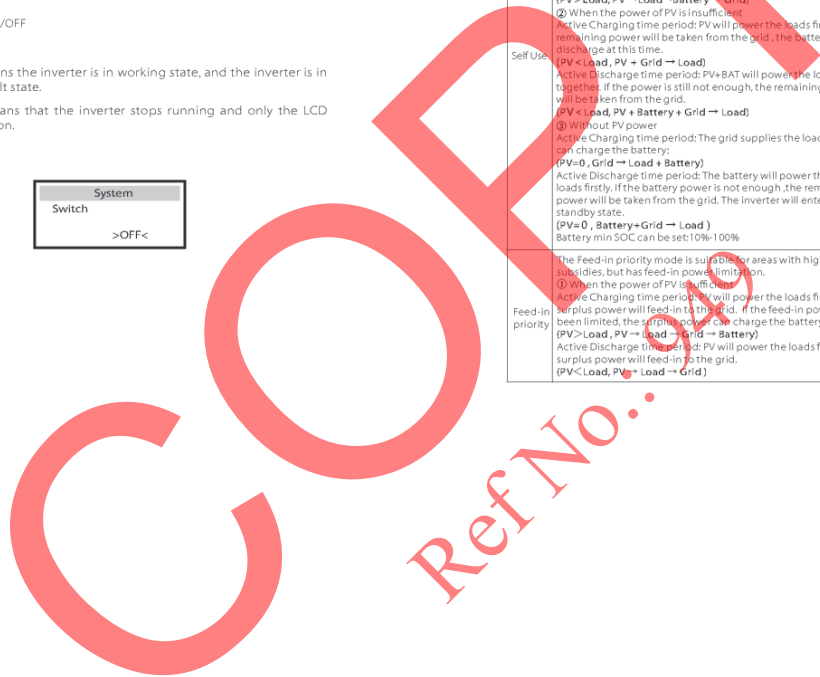



APPENDIX C. X3-Hybrid Series User Manual 5.0kW – 15.0kW. (Cont.)

Setting

Feed-in priority	<p>② When the power of PV is insufficient Active Charging time period: PV will power the loads firstly, the remaining power will be taken from the grid. The battery will not discharge. (PV &lt; Load, PV + Grid → Load)</p> <p>Discharge time period: PV+BAT will power the loads together. If the power is still not enough, the remaining power will be taken from the grid. (PV &lt; Load, PV + Battery + Grid → Load)</p> <p>③ Without PV power Active Charging time period: The grid will power the home loads and also charge the battery: (PV=0, Grid → Load + Battery)</p> <p>Active Discharge time period: The battery will power the home loads firstly. If the battery power is not enough, the remaining power will be taken from the grid. The inverter will enter into the standby state. (PV=0, Battery+Grid → Load)</p> <p>Battery min SOC can be set: 10%-100%.</p>
Backup mode	<p>The back-up mode is suitable for areas with frequent power outages. Same working logic with "Self-use" mode. This mode will maintain the battery capacity at a relatively high level. (Users' setting) to ensure that the emergency loads can be used when the grid is off. Customers no need to worry about the battery capacity. Battery min SOC can be set: 30%-100%. Backup mode. SOC adjustment range: 30%-100% In Backup mode, SOC-min under EPS(Off-grid) condition is 10%, which cannot be modified.</p>
EPS (Off-grid)	<p>The EPS(Off-grid) mode is used when the power grid is off. System will provides emergency power through PV and batteries to supply power to the household loads. (Battery is necessary)</p> <p>① When the power of PV is sufficient PV will power the loads firstly, and surplus power will charge to the battery. (PV &gt; Load, PV → Load + Battery)</p> <p>② When the power of PV is insufficient The remaining power will be taken from the battery. (PV &lt; Load, PV + Battery → Load + Battery)</p> <p>③ Without PV power The battery will power the emergency loads until the battery reached the min SOC, then the inverter will enter into the idle mode. (PV=0, Battery → Load)</p>

Note: In the case of grid connection, all working modes work normally when the battery SOC > 5%. When the battery charge rate is below 5%, the PV or Grid will first charge the battery SOC 11%, and then return to the working mode selected by the

• Manual mode (manual mode), there are three options to choose from: forced charging, forced discharge, stop charging and discharging (grid-connected 0 power).

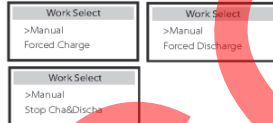

80

Setting

System Status

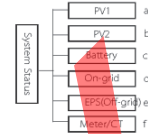

System status contains six content: PV1 /PV2/Battery/On-grid (energy feed into or buy from the grid) and EPS(Off-grid) and so on. Press up and down to select, press "Enter" to confirm the selection, and press "ESC" to return to the menu.

a/b) PV1, PV2 Here you can see the voltage, current and power of the pv1 and Pv2. Photovoltaic panels respectively:



c) Battery This status shows the battery condition of the system. Including battery voltage and battery current, Battery power, battery capacity, battery temperature, BMS connection status. The meaning of the sign of battery current and power: "+" means charging; "-" means discharging.

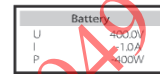

81

COPY

Ref No.: 949





## APPENDIX C. X3-Hybrid Series User Manual 5.0kW – 15.0kW. (Cont.)

Setting

Setting

d) On-grid  
Here you can see the voltage, current, frequency, and power of the grid.

On-grid	
U	0.0V
I	0.0A
P	0.0W

e) EPS(Off-grid)  
Here you can see the inverter of voltage, current, frequency and power when EPS(Off-grid),

EPS(Off-grid)	
U	
I	
P	

f) Meter/CT  
Here you can see the data showing the meter or the CT.

Meter/CT	
>Meter/CT1-A	0000Kw
Meter/CT1-B	0000Kw

► History Yield

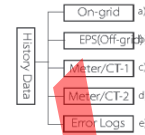

The history data contains five pieces of information: on-grid power of the inverter, EPS(Off-grid) power generation, power of the meter /CT and error Error logs.

Press up and down to select, press Enter to confirm selection, and press ESC to return to the menu.

a) On-grid  
Here is a record of the power capacity of the inverter connected to the grid today and the total.

On-grid	
Output Today	
Output Total	
Input Today	

b) EPS(Off-grid)  
Here you can see the EPS(Off-grid) output of the inverter today and the total output.

EPS(Off-grid)	
Today	
Total	00.0kWh

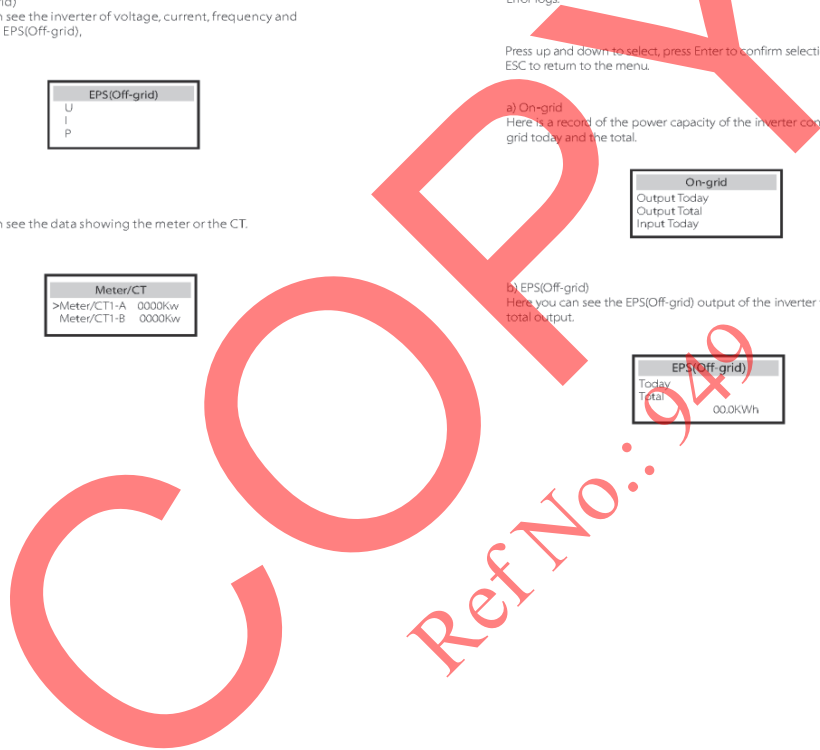



# Compliance Evaluation Report



REPORT No.: CSSC/BOS/012

ISSUED DATE: August 20, 2021

## APPENDIX C. X3-Hybrid Series User Manual 5.0kW – 15.0kW. (Cont.)

Setting

c) Meter /CT-1  
Here you can see the inverter's electricity sold, total electricity sold, electricity bought from the grid and total electricity bought on that day.

Meter CT-1
>FeedInToday:
00.0KWh

d) Meter /CT-2  
Here you can see the total power output of the inverter for the day.

Meter CT-2
>Output Today:
00.0KWh

e) Error Logs  
Here you can see the most recent six error messages.

Error logs
>No error

84

Setting

> Settings

Date&Time	a)
Language	b)
EPS(Off-grid) mode	c)
Self-use mode	d)
Feed-in Priority mode	e)
Backup mode	f)
Chrg & dischrg period	g)
Dry Contact	h)
User Password	i)

Here you can set the inverter time, language, working mode SOC, charging and discharging time period and user password.

User Setting
Date Time
Language
EPS(Off-grid) mode

a) Date time  
This interface is for users to set the system date and time.

Date time
>2021-08-15
0:00

85

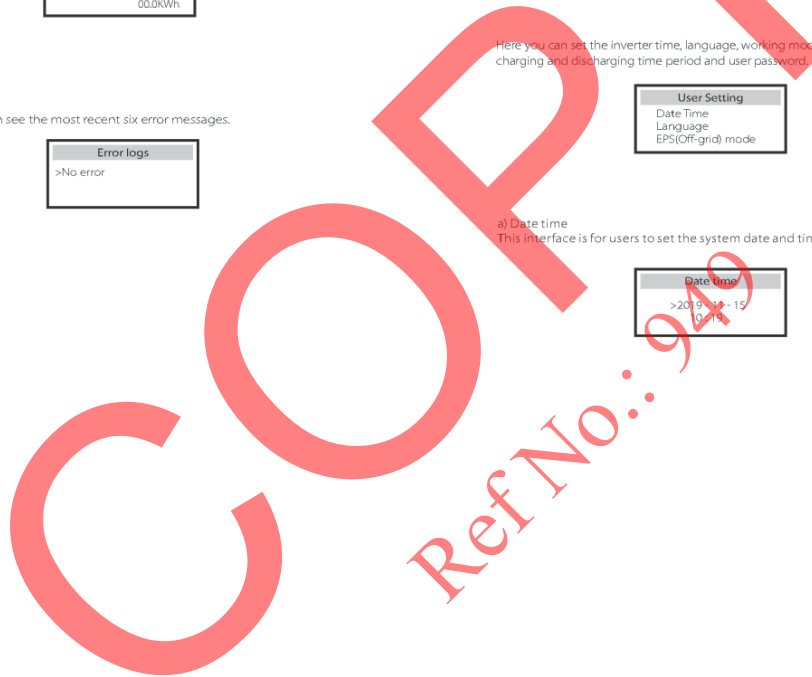



# Compliance Evaluation Report



REPORT No.: CSSC/BOS/012

ISSUED DATE: August 20, 2021

## APPENDIX C. X3-Hybrid Series User Manual 5.0kW – 15.0kW. (Cont.)

Setting

Setting

b) Language  
This inverter provides multiple languages for customers to choose.

Language
> Select
English

c) EPS(Off-grid) Mute  
Here you can choose whether the buzzer is turned on when the inverter is running in EPS(Off-grid) mode. Select Yes, the buzzer mutes, select NO, EPS(Off-grid) mode, the buzzer will sound once every 4s when the battery is fully charged, the closer the battery is to the empty state, the higher the buzzer will sound, to remind users to avoid battery loss .

EPS(Off-grid) Mute
> Mute:
Yes

d) Self-use mode  
In this mode, you can set the power reserve percentage of the minimum battery state, set whether the power can be taken from the mains side to charge the battery, and set the amount of power to charge the battery. For example: set the reserved minimum SOC of the battery capacity to "10%", which means that when the battery has been discharged to 10% of the battery capacity, the battery is not allowed to continue to discharge; When Charge from grid is set to "Enable", the utility power is allowed to charge the battery; when set to "Disable", the utility power is not allowed to charge the battery; Charge battery to is set to 90%, indicating that the mains is allowed to charge the battery at 90%.

Self-use Mode	Self-use Mode
> Min SOC:	> Charge from grid
10%	Disable
Self-use Mode	
> Charge battery to	
90%	

e)Feed-in Priority mode  
In this mode, you can set the power reserve percentage of the minimum battery state, set whether the power can be taken from the mains side to charge the battery, and set the amount of power to charge the battery. For example: set the reserved minimum SOC of the battery capacity to "10%", which means that when the battery has been discharged to 10% of the battery capacity, the battery is not allowed to continue to discharge; When Charge from grid is set to "Enable", the utility power is allowed to charge the battery; when set to "Disable", the utility power is not allowed to charge the battery; Charge battery to is set to 90%, indicating that the mains is allowed to charge the battery at 90%.

Feed-in Priority mode	Feed-in Priority mode
> Min SOC:	> Charge from grid
10%	Disable
Feed-in Priority mode	
> Charge battery to	
90%	

86

87

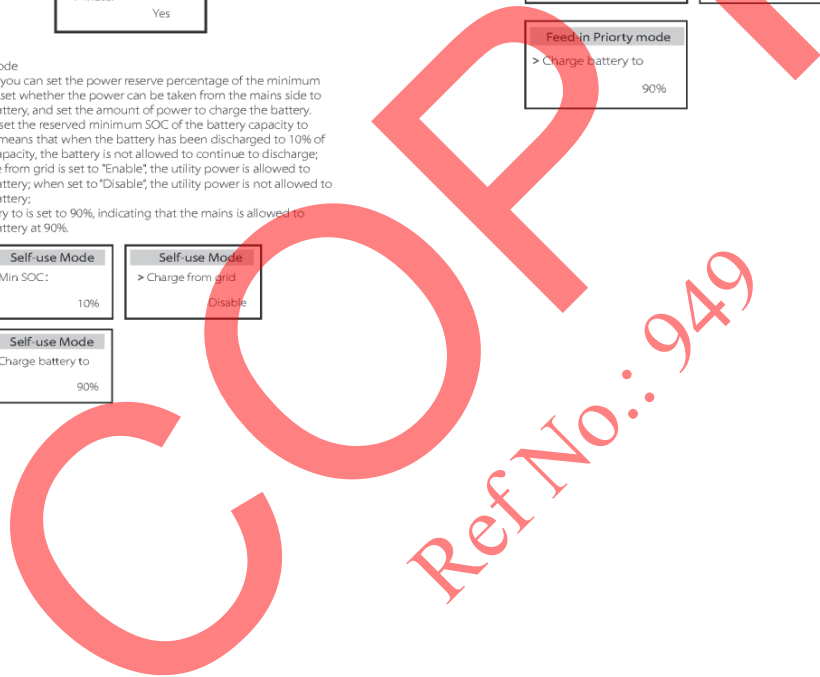





## APPENDIX C. X3-Hybrid Series User Manual 5.0kW – 15.0kW. (Cont.)

Setting
Setting

f) Backup mode  
In this mode, you can set the power reserve percentage of the minimum battery state, set whether the power can be taken from the mains side to charge the battery, and set the amount of power to charge the battery.  
For example: set the reserved minimum SOC of the battery capacity to "10%", which means that when the battery has been discharged to 10% of the battery capacity, the battery is not allowed to continue to discharge.  
When Charge from grid is set to "Enable", the utility power is allowed to charge the battery when set to "Disable", the utility power is not allowed to charge the battery.  
Charge battery to is set to 90%, indicating that the mains is allowed to charge the battery at 90%.

**Backup mode**

> Min SOC:

10%

**Backup mode**

> Charge from grid

Disable

**Backup mode**

> Charge battery to

90%

h) Dry Contact  
When the user uses the inverter communication control external device function, you can enter here to set the parameters of the external response control. For the setting method, please refer to the user manual of the compatible external device.

**Allowed Disc Period**

> Start Time

00:00

**Allowed Disc Period**

> End Time

00:00

**Chrg&Dischrg Period2**

> Function

Enable    Disable

**Load Management**

> Mode Select

Disable

g) Charge and discharge time  
Here you can set the charge and discharge time period.  
If two charging and discharging periods are needed, turn on the charging and discharging period.2 and set the period.

**Chrg&Dischrg Period**

> Charge Period

Start Time

**Charge Period**

> Charge Period

End Time

i) User Password  
The default password for the end user is "0000", where you can reset the new password and press the up/down key to increase or decrease the value. Press "Enter" to confirm the value and jump to the next digit. When all passwords have been entered and confirmed, press "OK" to set the password successfully.

**User Password**

>

0   0   0   0

88

89

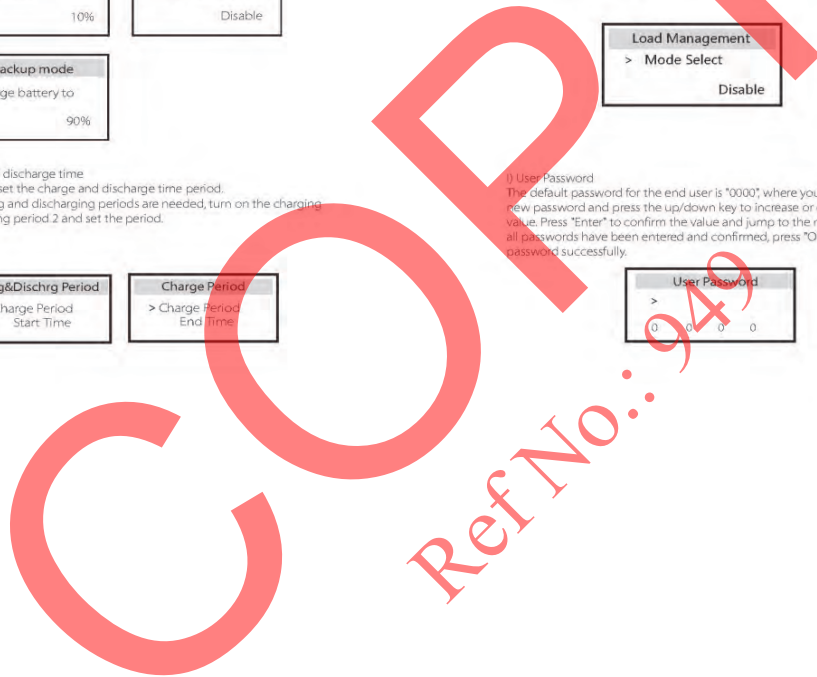



# Compliance Evaluation Report



REPORT No.: CSSC/BOS/012

ISSUED DATE: August 20, 2021

## APPENDIX C. X3-Hybrid Series User Manual 5.0kW – 15.0kW. (Cont.)

Setting

Setting

➤ Advance settings

- Safety Code a)
- Grid Parameters b)
- Export Control c)
- Meter/CT Settings d)
- Self Test e)
- Shadow Fix f)
- Modbus g)
- Matebox Setting h)
- Power Factor i)
- Pu Function j)
- PVRT Function k)
- Power limit l)
- DRM Function m)
- Main Breaker Limit n)
- Battery Heating o)
- EPS(OFF-grid) Setting p)
- Reset q)
- Advance Password r)

All advanced settings can be set here, such as battery, grid, EPS(OFF-grid), etc.

\*Advanced\* setting is generally customization and resetting for battery and grid. Each part has lower level parts.



\* Please note that when the inverter DSP communication fails, all advanced settings will be hidden.



a) Safety Code

Users can set safety standards according to different countries. There are now 1 standards to choose from. (There may be changes in the future, please refer to the screen display)

Item	Standard	Country
1	ARN 4105	German

- OverVoltage\_L1
- UnderVoltage\_L1
- OverFreq\_L1
- UnderFreq\_L1
- Vac\_10min Avg
- OverVoltage\_L2
- UnderVoltage\_L2
- OverFreq\_L2
- UnderFreq\_L2
- OverFreq\_L2
- UnderFreq\_L2
- Tovp\_L1
- Tuyp\_L1
- Tofp\_L1
- Tovp\_L2
- Tuyp\_L2
- Tofp\_L2
- Tuyp\_Fast
- Reconnection Time
- Checking Time
- W(Grid)
- OFF\_StartPoint
- UFPL\_SetRate
- OFF\_DelayTime
- UFPL\_StartPoint
- UFPL\_SetRate
- UFPL\_DelayTime

90

91

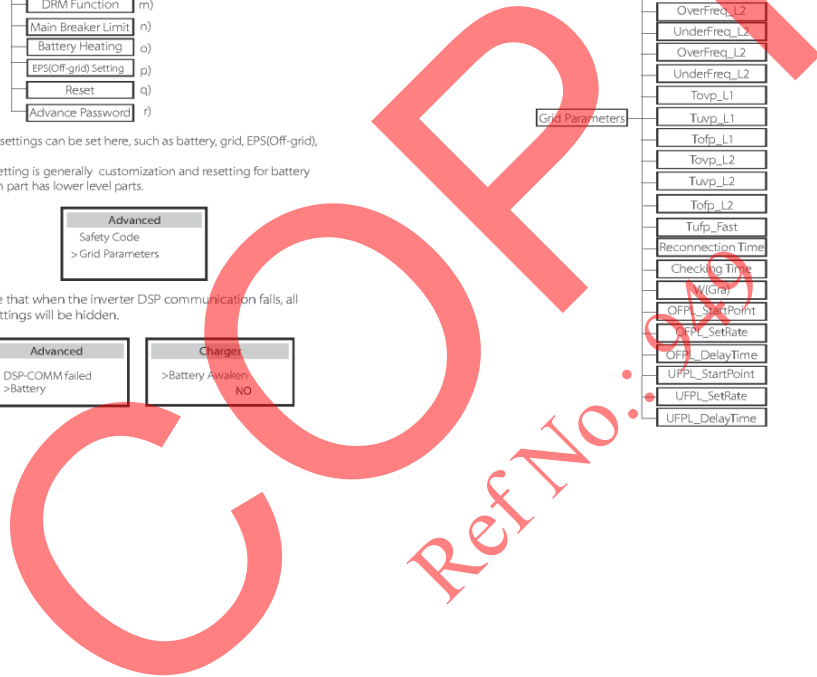



# Compliance Evaluation Report



REPORT No.: CSSC/BOS/012

ISSUED DATE: August 20, 2021

## APPENDIX C. X3-Hybrid Series User Manual 5.0kW – 15.0kW. (Cont.)

Setting

### b) Grid Parameters

Here you can set the protection value of grid voltage and frequency. The default value is the specified value under the current safety regulations, and the user cannot change it.

The display content will be displayed according to the requirements of local laws and regulations, which are constantly increasing. Please refer to the contents displayed on the inverter screen.

Grid >OverVoltage_L1 0.0V	Grid >UnderVoltage_L1 0.0V
Grid >OverFreq_L1 0.0Hz	Grid >UnderFreq_L1 0.0Hz
Grid >Vac 10min Avg 0.0V	Grid >OverVoltage_L2 0.0V

### c) Export Control

This feature allows the inverter to control the amount of electricity output to the grid.

The factory value is the default and can be changed by the user. The user value set by setup must be less than the maximum. If the user does not want to supply power to the grid, set it to 0.

Export Control User value: 0W
----------------------------------

### d) Meter/CT Settings

The user needs to select the CT or electricity meter to connect the inverter here. Select the address of the meter. CT does not need to select the address.

CT/Meter Setting > Select Meter	CT/Meter Setting > Meter 1 Addr: XXXXXXXX
---------------------------------------	---

92

Setting

### e) Self Test (only for CEI 0-21)

The self test function allows users to test the following items: "Full test", "Ovp(59.52) test", "Uvp (s1) test", "Uvp (27.52) test", "Ofp (81 > .S1) test", "Ufp (81 <.S1) test", "Ufp (81 > .S2) test", "Ufp (81 <.S2) test", "Ovp10 (59.51) test".

In the self-test interface, the user can select "all tests" or a single test item for testing.

Before testing, make sure that the inverter is connected to the grid.

All tests take about 6 minutes. And it will display "Success" and then "Delivery".

For a single test item, it takes about a few seconds or minutes.

Click "Test Report" to view the test results of all items.

Self Test ALL Test Test report Uvp(27.51) test	>Ovp2(81>.S2)result Ft: 51.50Hz Tt: 1000ms Fs: 0.00Hz To: 998ms Ff: 0.00Hz pass	>Ovp2(59.52)result Vt: 26.45V Tt: 300ms Vs: 0.0V To: 200ms Vf: 0.0V pass
>Ovp2(27.52)result Vt: 92.0V Tt: 200ms Vs: 0.0V To: 196ms Vf: 0.2V pass	>Uvp2(27.51)result Vt: 195.5V Tt: 400ms Vs: 0.0V To: 200ms Vf: 0.0V pass	>Ufp2(81<.S1)result Ft: 49.50Hz Tt: 100ms Fs: 0.00Hz To: 98ms Ff: 0.02Hz pass
>Ovp2(81>.S1)result Ft: 56.50Hz Tt: 100ms Fs: 0.00Hz To: 96ms Ff: 0.2Hz pass	>Ufp2(81<.S2)result Ft: 47.50Hz Tt: 400ms Fs: 0.00Hz To: 3999ms Ff: 0.02Hz pass	>Ovp10(59.51)result Vt: 253.0V Tt: 600ms Vs: 0.0V To: 598ms Vf: 0.0V pass

### f) Shadow Fix

Here, you can set the shadow tracking with four options, which are off, low, medium, and high.

Shadow Fix > Func Select >OFF<
--------------------------------------

93





# Compliance Evaluation Report



REPORT No.: CSSC/BOS/012

ISSUED DATE: August 20, 2021

## APPENDIX C. X3-Hybrid Series User Manual 5.0kW – 15.0kW. (Cont.)

Setting

g) Modbus  
Here you select the baud rate of the external communication protocol, the default location of 19200 and 485 addresses.

<b>Modbus RTU/485</b> Baud Rate: 115200	<b>Modbus RTU/485</b> RS485 Addr: 1
---	---

h) Matebox Setting  
If you want MateBox installed, you need to turn this feature on here.

<b>Matebox Setting</b> > Select Disable    Enable
---

i) Power Factor (applicable to specific countries, please refer to local grid requirements.)

<b>Power Factor</b> Mode Select > Off <	<b>Power Factor</b> Mode Select > Over-Excited <
<b>Power Factor</b> Mode Select > Under-Excited <	<b>Power Factor</b> Mode Select > Curve <
<b>Power Factor</b> Mode Select > Q(u) <	

Mode	Comment
Off	-
Over-Excited	PF value
Under-Excited	PF value
	P1_Pf (EU50549 only)
	P2_Pf (EU50549 only)
	P3_Pf (EU50549 only)
	P4_Pf (EU50549 only)
Curve	Power1
	Power2
	Power3
	Power4
	PF LockPoint (EU50549 only)
	PF LockOutPoint (EU50549 only)
	3Tau
	VOLTRATIO 1 (AS4772 only)
	VOLTRATIO 2 (AS4772 only)
	QRESPONSEV1 (EU50549 only)
	QRESPONSEV2 (EU50549 only)
	QRESPONSEV3 (EU50549 only)
	QRESPONSEV4 (EU50549 only)
	K Value (CEI 0-21 only)
	3Tau
	QDelayTimer
Fixed Q Power	Q Power

j) PU Function (applicable to specific countries, please refer to local grid requirements)

The PU function is a volt-watt response mode required by certain national standards such as AS4772. This function can control the active power of the inverter according to the grid voltage. Selecting "Enable" means that this function is turned on and is the default value. Select "Disable" to deactivate the function.

<b>PU Function</b> >PuFunction Enable	<b>PU Function</b> Response V2 220.0V
---	---

94

95





## APPENDIX C. X3-Hybrid Series User Manual 5.0kW – 15.0kW. (Cont.)

Setting
Setting

<b>PU Function</b>
Response V3
250.0V

<b>PU Function</b>
Response V4
265.0V

<b>PU Function</b>
3Tau
6-180S

k) FVRT Function (apply to 50549)  
Here you can set the high and low enable or disable.

<b>FVRT Function</b>
Function Control
Disable    Enable

l) Power limit  
Power limit function, the maximum power of the AC port can be set by percentage.

<b>Power Limit</b>
>Proportion
1.00

- Reactive power control, reactive power standard curve  $\cos \phi = f(P)$   
For VDE ARN 4105, the curve  $\cos = f(P)$  should refer to curve B. The set default value is shown in curve B.

For e8001, the curve  $\cos = f(P)$  should be curve A. The set default value is shown in curve A.

For CEI 0-21, the default value of PFLockInPoint is 1.05. When  $V_{ac} > 1.05V_n$ ,  $P_{ac} > 0.2 P_n$ , curve  $\cos \phi = f(P)$  corresponds to curve B.

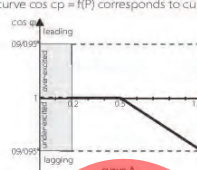

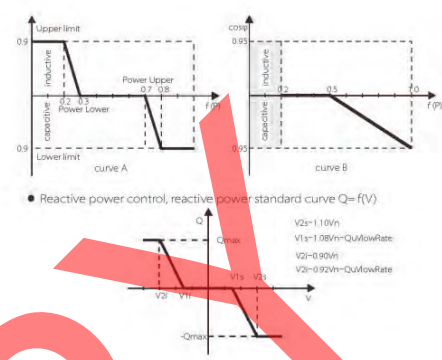

- Reactive power control, reactive power standard curve  $Q = f(V)$

m) DRM function (applied to NZS4777.2)  
The DRM function is a demand response method required by the NZS4777.2 standard and is only applicable to NZS4777.2. The default value is "enable". Select "Disable" to disable this function.

<b>DRM Function</b>
>Function Control
Enable

n) Main Breaker Limit  
Here you can set an open minimum current here.

<b>Main Breaker Limit</b>
Current
40A

COPY

Ref No.: 0129

96
97





## APPENDIX C. X3-Hybrid Series User Manual 5.0kW – 15.0kW. (Cont.)

Setting

### (c) Battery Heating

If the user needs the battery heating function, you can set it to turn on here, and set the time period that needs to be heated, and the two time periods can be set. (Only for batteries with heating function)

<b>Battery Heating</b> >Func Select: Enable    Disable	<b>Battery Heating</b> >Heating Period 1 Start Time 00:00	<b>Battery Heating</b> >Heating Period 1 End Time 00:00
<b>Battery Heating</b> >Heating Period 2 Start Time 00:00	<b>Battery Heating</b> >Heating Period 2 End Time 00:00	

### (p) EPS(Off-grid) Setting

User can set the frequency selection in the EPS(Off-grid) mode here, and set the minimum capacity reserved for battery discharge.

<b>EPS(Off-grid) Setting</b> > Frequency 50Hz	<b>EPS(Off-grid) Setting</b> >Frequency 60Hz	<b>EPS(Off-grid) Setting</b> > Min SoC 10%
---	--	--

### a) Reset

Users can reset the reset error log, meter power, inverter power, and restore factory settings here.

<b>Reset Error Log</b> >Reset Yes	<b>Reset Meter/CT_1</b> >Reset Yes	<b>Reset Meter/CT_2</b> >Reset Yes
<b>Reset INV Energy</b> >Reset Yes	<b>Factory Reset</b> >Reset Yes	

### Advance Password

Here you can reset the advanced password. "Set OK" is displayed on success, and "Setup Failed!" Will also displayed on failure.

<b>Advance Password</b> Set OK	<b>Advance Password</b> Setup failed
-----------------------------------	---

98

Setting

### > Manufacturing Setting

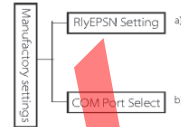

### a) R1yEPSN Setting

The user needs to set whether the inverter is installed in Australia or Europe. When the inverter is off the grid, the N line and PE line of the circuit in Australia need to be connected; the N line and PE line of the European circuit need to be separated.

<b>R1yEPSN Setting</b> >function Control Europe	<b>R1yEPSN Setting</b> >function Control Australia
---	--

### b) COM Port Select

Here external communication protocol or external indoor screen of the inverter can be set. When it is used for external communication protocol, it can choose RS485 or MOBUS.

<b>RS485/MOBUS</b> > RS485 MOBUS
--

99





# Compliance Evaluation Report



REPORT No.: CSSC/BOS/012

ISSUED DATE: August 20, 2021

## APPENDIX C. X3-Hybrid Series User Manual 5.0kW – 15.0kW. (Cont.)

Setting
Setting

> About

- About
  - Inverter
    - Inverter SN
    - Register SN\*
    - DSP
    - ARM
    - On-grid Run Time
    - EPS(Off-grid) Run Time
  - Battery
    - Bat\_PS1 SN
    - Bat\_PS2 SN
    - Bat\_PS4 SN
    - BatteryM Version
    - BatteryS Version
  - Internal Code
    - Inverter code
    - BMS Code

a) About  
Here you can see some basic information of the inverter and battery, such as the inverter and battery SN number, software version number, and system run time.

**About**

> Inverter  
> Battery

**Inverter**

> Inverter SN  
01234560123456

> DSP  
2.07

> System runtime  
1.02

**Inverter**

> Register  
01234560123456

> ARM  
1.03

\* Register1 SN: Represents the serial number of external monitoring equipment, such as Pocket WiFi, Pocket LAN and Pocket GPS.

100
101

COPY

Ref No.: 949





## APPENDIX C. X3-Hybrid Series User Manual 5.0kW – 15.0kW. (Cont.)

Setting

Troubleshooting

### Battery

<b>Battery</b> >Bat Brand BAK	<b>Battery</b> >Bat MSN 65012345012345
<b>Battery</b> >Bat P51 SN 65012345012345	<b>Battery</b> >Bat P52 SN 65012345012345
<b>Battery</b> >Bat P53 SN 65012345012345	<b>Battery</b> >Bat P54 SN 65012345012345
<b>Battery</b> >BatteryMVersion 2.01	<b>Battery</b> >BatteryMVersion 2.01

### Internal Code

<b>Internal Code</b> >Inverter code 01 00 01 xx	<b>Internal Code</b> >BMS code
<b>Internal Code</b> >BAT M 2.01	<b>Internal Code</b> >BAT S1 1.01 50
<b>Internal Code</b> >BAT S2 1.01 50	... <b>Internal Code</b> >BAT S8 1.01 50

## 8 Troubleshooting

### 8.1 Troubleshooting

This section contains information and procedures for resolving possible problems with X3-Hybrid G4, and provides you with troubleshooting tips to identify and solve most problems that may occur in X3-Hybrid G4. This section will help you narrow down the source of any problems you may encounter. Please read the troubleshooting steps below. Check the warning or fault information on the system control panel or the fault code on the inverter information panel. If a message is displayed, log it before doing anything further.

Try the solutions indicated in the table below.

Number	Faults	Diagnosis and solution
IE 001	TZ Protect Fault	Overcurrent fault • Wait for a while to check if you're back to normal. • Disconnect PV and battery, reconnect. • Or ask for help from the installer if it can't return to normal.
IE 002	Grid Lost Fault	• Check battery input voltage if it's within normal range • Or ask the installer for help.
IE 003	Grid Volt Fault	Power grid voltage overrun • Wait a moment, if the utility returns to normal, the system will reconnect. • Please check if the grid voltage is within normal range. • Or ask the installer for help.
IE 004	Grid Freq Fault	Electricity frequency beyond range. • If the utility returns to normal, the system reconnects. • Or ask the installer for help.
IE 005	PV Volt Fault	PV voltage out of range • Check the output voltage of the PV panel. • Or ask the installer for help.
IE 006	Grid Volt Fault	• press the "ESC" key to restart the inverter. • Check that the PV output open circuit voltage is in the normal range. • Or ask the installer for help.
IE 007	Bat Volt Fault	Battery voltage fault • Check battery input voltage if it's within normal range • Or ask the installer for help.
IE 008	AC10M Volt Fault	• The grid voltage was out of range in the last 10 minutes. • The system will return to normal if the grid returns to normal. • Or ask the installer for help.

102

103







# Compliance Evaluation Report



REPORT No.: CSSC/BOS/012

ISSUED DATE: August 20, 2021

## APPENDIX C. X3-Hybrid Series User Manual 5.0kW – 15.0kW. (Cont.)

Troubleshooting

Troubleshooting

Number	Faults	Diagnosis and solution
IE 009	DC OCP Fault	DC overcurrent protection fault. • Wait for a while to check if it's back to normal. • Or ask the installer for help.
IE 010	DCV OVP Fault	DCV EP(S)OFF grid overvoltage protection failure. • Wait for a while to check if it's back to normal. • Or ask the installer for help.
IE 011	SW OCP Fault	<b>Software Detection of Overcurrent Fault</b> • <b>Wait for a while to check if it's back to normal.</b> • <b>Shut down photovoltaic, battery and grid connections.</b> • <b>Or ask the installer for help.</b>
IE 012	RC OCP Fault	Overcurrent protection fault. • Check the impedance of DC input and AC output. • Wait for a while to check if it's back to normal. • Or ask the installer for help.
IE 013	Isolation Fault	Insulation Fault • Please check the wire insulation for damage. • Wait for a while to check if it's back to normal. • Or ask the installer for help.
IE 014	Temp Over Fault	Temperature beyond limit • Check if ambient temperature exceeds the limit. • Or ask the installer for help.
IE 015	Bat Con Dir Fault	EP(S)OFF grid mode current is too strong. • Ensure that the load power is within the EP(S)OFF grid power range. • Check for any non linear load connections on the EP(S)OFF grid. • Move this load to check for recovery. • Or ask for help from the installer if it can not return to normal.
IE 016	EP(S)OFF grid Overload Fault	EP(S)OFF grid over load fault. • Shutdown the high power device and press the "ESC" key to restart the inverter. • Or ask for help from the installer if it can not return to normal.
IE 017	Over Load Fault	On grid mode over load • Shutdown the high power device and press the "ESC" key to restart the inverter. • Or ask for help from the installer if it can not return to normal.
IE 018	Bat Power Low	• <b>Close the high power device and press the "ESC" key to restart the inverter.</b> • <b>Please charge the battery to a level higher than the protection capacity or protection voltage.</b>
IE 019	BMS Lost	Battery communication loss • Check that the communication lines between the battery and the inverter are properly connected. • Or ask for help from the installer if it can not return to normal.
IE 020	Fan Fault	Fan Fault • Check for any foreign matter that may have caused the fan not to function properly. • Or ask for help from the installer if it can not return to normal.
IE 021	Low Temp	Low temperature fault. • Check if the ambient temperature is too low. • Or ask for help from the installer if it can not return to normal.

104

Number	Faults	Diagnosis and solution
IE 022	ARM Unmatched	ARM software version mismatch Fault • update the software and press the "ESC" key to restart the inverter. • Or ask for help from the installer if it can not return to normal.
IE 023	Other Device Fault	Other device Fault • update the software and press the "ESC" key to restart the inverter. • Or ask for help from the installer if it can not return to normal.
IE 025	InterComms Error	My InterCom Fault • Shut down photovoltaic, battery and grid, reconnect. • Or ask for help from the installer if it can not return to normal.
IE 025	InterComms Error	• Internal communication errors • Shut down photovoltaic, battery and grid connections. • Or ask for help from the installer if it can not return to normal.
IE 026	Inv EEPROM Fault	<b>Inverter EEPROM Fault</b> • <b>Shut down photovoltaic, battery and grid, reconnect.</b> • <b>Or ask for help from the installer if it can not return to normal.</b>
IE 027	RCD Fault	Fault of Residual Current Device • Check the impedance of DC input and AC output. • Disconnect PV+ PV- and batteries, reconnect. • Or ask for help from the installer if it can not return to normal.
IE 028	Grid Relay Fault	Electrical relay failure • Disconnect PV+ PV- grid and batteries and reconnect. • Or ask for help from the installer if it can not return to normal.
IE 029	EP(S)OFF grid Relay Fault	EP(S)OFF grid relay failure • Disconnect PV+ PV- grid and batteries and reconnect. • Or ask for help from the installer if it can not return to normal.
IE 030	PV ConnDir Fault	PV direction fault • Check if the PV input lines are connected in the opposite direction. • Or ask for help from the installer if it can not return to normal.
IE 031	ChargeRelay Fault	Charge relay fault • Press the "ESC" key to restart the inverter. • Or ask for help from the installer if it can not return to normal.
IE 032	EarthRelay Fault	EP(S)OFF grid earth relay fault • Press the "ESC" key to restart the inverter. • Or ask for help from the installer if it can not return to normal.
IE 101	PowerType Fault	Power type fault • Upgrade the software and press the "ESC" key to restart the inverter. • Or ask for help from the installer if it can not return to normal.
IE 102	Port OCP Warning	EP(S)OFF grid over current fault • Check that the EP(S)OFF grid load does not exceed the system requirements and press the "ESC" key to restart the inverter. • Or ask for help from the installer if it can not return to normal.

105

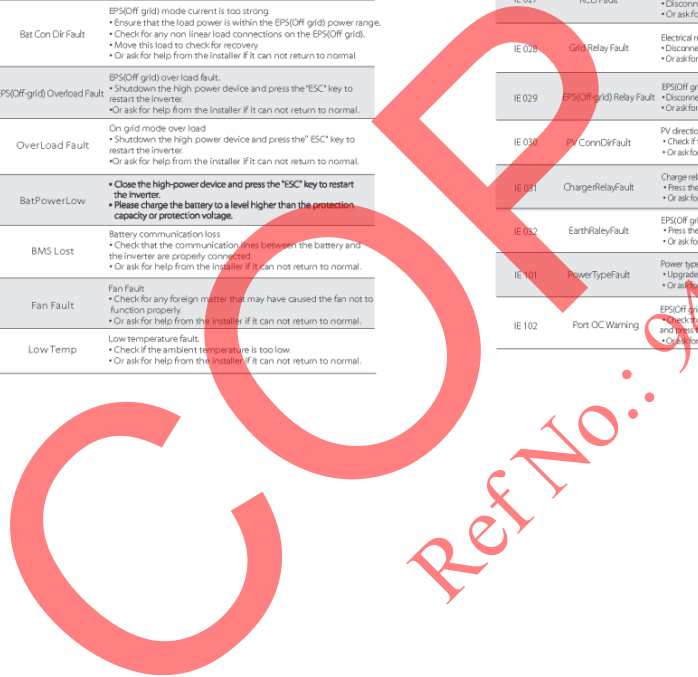



# Compliance Evaluation Report



REPORT No.: CSSC/BOS/012

ISSUED DATE: August 20, 2021

## APPENDIX C. X3-Hybrid Series User Manual 5.0kW – 15.0kW. (Cont.)

Troubleshooting

Troubleshooting

Number	Faults	Diagnosis and solution
IE 103	Mgr EEPROM Fault	Manage EEPROM Fault • Shut down photovoltaic, battery and grid, reconnect. • Or seek help from the installer, if it can not return to normal.
IE 104	DSPUnmatched	<b>DSP version error</b> • Check that the <b>DSP1</b> version matches. • Or seek help from the installer, if it can not return to normal.
IE 105	NTCSampleInvalid	NTC Invalid • Make sure the NTC is properly connected and the NTC is in good condition. • Please confirm that the installation environment is normal. • Or ask for help from the installer, if it can not return to normal.
IE 106	BatTempLow	Battery temp low • Check the battery installation environment to ensure good heat dissipation. • Or ask for help from the installer, if it can not return to normal.
IE 107	BatTempHigh	Battery temp high • Check the battery installation environment to ensure good heat dissipation. • Or ask for help from the installer, if it can not return to normal.
IE 109	Meter Fault	Meter error • Please check that the instrument is working properly. • Or seek help from the installer, if it can not return to normal.
IE 110	BypassRelyFault	Bypass rely fault • Press the "ESC" key to restart the inverter. • Or ask for help from the installer, if it can not return to normal.
BE 001	BMS_Extrenal_Err	Battery Error - External Communication Fault • Please contact the battery supplier.
BE 002	BMS_Internal_Err	Battery Error - Internal Communication Fault • Please contact the battery supplier.
BE 003	BMS_OverVoltage	Over voltage in battery system • Please contact the battery supplier.
BE 004	BMS_LowerVoltage	Low voltage in battery system • Please contact the battery supplier.
BE 005	BMS_ChargeOCP	Battery fault - over charge fault • Please contact the battery supplier.
BE 006	BMS_DischargeOCP	Battery fault - discharge over current fault • Please contact the battery supplier.
BE 007	BMS_TempHigh	Over temperature in battery system • Please contact the battery supplier.
BE 008	BMS_TempSensor Fault	Battery temperature sensor malfunction • Please contact the battery supplier.

106

Number	Faults	Diagnosis and solution
BE 009	BMS_CellImbalance	Battery Unbalanced Failure • Please contact the battery supplier.
BE 010	BMS_Hardware_Protect	Battery hardware protection failure • Please contact the battery supplier.
BE 011	BMS_Circuit_Fault	Battery circuit failure • Restart the battery. • Please contact the battery supplier.
BE 012	BMS_ISO_Fault	Battery insulation failure • Check that the battery is properly grounded and restart the battery. • Please contact the battery supplier.
BE 013	BMS_VolSen_Fault	Battery voltage sensor fault • Please contact the battery supplier.
BE 014	BMS_TempSen_Fault	Temperature sensor failure • Restart the battery. • Please contact the battery supplier.
BE 015	BMS_CurSensor Fault	Battery current sensor fault • Please contact the battery supplier.
BE 016	BMS_Rely Fault	Battery rely failure • Please contact the battery supplier.
BE 017	BMS_Type_Unmatch	Battery type failure • Upgrade the battery BMS software. • Please contact the battery supplier.
BE 018	BMS_Ver_Unmatch	Battery version mismatch failure • Upgrade the battery BMS software. • Please contact the battery supplier.
BE 019	BMS_MFR_Unmatch	Battery manufacturer did not match the fault • Upgrade the battery BMS software. • Please contact the battery supplier.
BE 020	BMS_SW_Unmatch	Battery hardware and software mismatch failure • Upgrade the battery BMS software. • Please contact the battery supplier.
BE 021	BMS_M85_Unmatch	Battery master slave control mismatches • Upgrade the battery BMS software. • Please contact the battery supplier.
BE 022	BMS_CR_NORespond	Battery charging request does not respond to a fault • Upgrade the battery BMS software. • Please contact the battery supplier.
BE 023	BMS_SW_Protect	Battery hardware protection failure • Upgrade the battery BMS software. • Please contact the battery supplier.
BE 024	BMS_S36_Fault	Battery fault - discharge over current fault • Please contact the battery supplier.
BE 025	BMS_SelfcheckErr	Over temperature in battery system • Please contact the battery supplier.

107

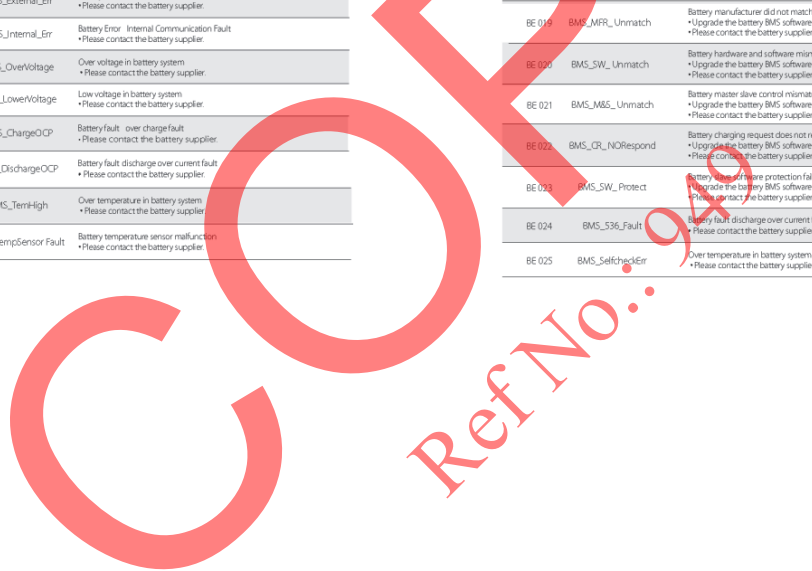



# Compliance Evaluation Report



REPORT No.: CSSC/BOS/012

ISSUED DATE: August 20, 2021

## APPENDIX C. X3-Hybrid Series User Manual 5.0kW – 15.0kW. (Cont.)

Troubleshooting

Number	Faults	Diagnosis and solution
BE 026	BMS_TempdFFErr	Battery temperature sensor malfunction • Please contact the battery supplier
BE 027	BMS_BreakFault	Battery Unbalanced Failure • Please contact the battery supplier
BE 028	BMS_Rash_Fault	Battery hardware protection failure • Please contact the battery supplier
BE 029	BMS_Precharge_Fault	Battery precharge failure • Please contact the battery supplier
BE 030	BMS_AirSwitch_Fault	Battery air switch failure • Check that the battery breaker is off • Please contact the battery supplier

• If the information panel of your inverter does not show the fault light, check the following list to ensure the current installation status, correct operation.

- Is the inverter located in a clean, dry and well-ventilated place?
- Is the DC input circuit breaker open?
- Is the specification and length of the cable adequate?
- Are the input and output connections and wiring in good condition?
- Is the configuration set correct for your particular installation?

**please contact Solax customer service for further assistance. Please be prepared to describe the details of your system installation and provide the inverter serial number.**

108

Troubleshooting

### 8.2 Routine Maintenance

Inverter do not require any maintenance or correction in most cases, but if the inverter often loses power due to overheating, this can be attributed to the following reason:

- **heat sink behind the inverter is covered with dirt.**  
If necessary, clean the cooling heat sink with a soft dry cloth or brush. Only trained and authorized professionals familiar with safety requirements can perform maintenance and maintenance work.

#### ➤ Safety inspections

Safety checks should be conducted at least every 12 months, please contact the manufacturer to arrange for appropriate training, expertise, and practical experience in performing these tests. (Please note that this action is not covered by warranty). These data should be recorded in the device log. If the equipment is not running properly or any test fails, the equipment must be repaired for details of safety inspections, refer to section 2 of this manual for safety instructions and Europe commission instructions.

#### ➤ Regular maintenance

##### **Only qualified people can do the following work.**

In the process of using frequency converter, the manager should check and maintain the machine regularly. The specific operation is as follows.

1. check whether the heat sink is covered with dirt, clean the machine and absorb dust if necessary. This work should be performed from time to time.
2. check whether the frequency converter indicator is normal, check whether the frequency converter button is normal, check whether the frequency converter display is normal. This inspection should be conducted at least every 6 months.
3. check the input and output lines for damage or aging. This inspection should be conducted at least every 6 months.
4. Cleaning and safety inspection of PV modules should be carried out at least once every 6 months.

109





## APPENDIX C. X3-Hybrid Series User Manual 5.0kW – 15.0kW. (Cont.)

Dismantling

Disclaimer

### 9 Decommissioning

#### 9.1 Disassemble the Inverter

- Remove DC input line and AC output line of inverter.
- Wait for at least 5 minutes to power off.
- Remove all cable connections from the inverter.
- Remove inverter from finger support the bracket.
- Remove the bracket if necessary.

#### 9.2 Packing

Load the inverter into the original package if possible.

- If the original package can not be found, you can also use the following requirements of the carton packaging:  
Bearing capacity of more than 30 kg.  
Easy to carry.  
Can completely seal the cover.

#### 9.3 Storage and Transportation

Store the inverter in a dry, temperature -40°C~70°C environment. Pay attention to less than four machines on each stack board during storage and transportation.

#### 9.4 Waste Disposal

If it is necessary to scrap the inverter or other related parts, be sure to send the waste inverter and packaging materials to the designated location for recycling by the relevant department.

### 10 Disclaimer

The X3-Hybrid G4 series hybrid inverters are transported, used and operated under limited condition, such as environmental, electrical etc. SolaX shall not be liable to provide the service, technical support or compensation under conditions listed below, including but not limited to:

- Inverter is damaged or broken by force majeure (such as earthquake, flooding, thunderstorm, lightning, fire hazard, volcanic eruption etc).
- Inverter's warranty is expired and doesn't buy extended warranty.
- Can't provide the inverter's SN, warranty card or invoice.
- Inverter is damaged by man-made cause. Inverter is used or operated against any items in local policy.
- Inverter's installation, configuration, commissioning doesn't follow the requirements mentioned in this manual.
- Inverter is installed, refitted or operated in improper ways mentioned in this manual without authority from SolaX.
- Inverter is installed, operated under improper environment or electrical condition mentioned in this manual without authority from SolaX.
- Inverter is changed, updated or disassembled on hardware or software without authority from SolaX.
- Obtain the communication protocol from other illegal channels.
- Build monitoring, control system without authority from SolaX.
- Connect to other brands batteries without authority from SolaX.

SolaX will keep right to explain all the contents in this user manual.

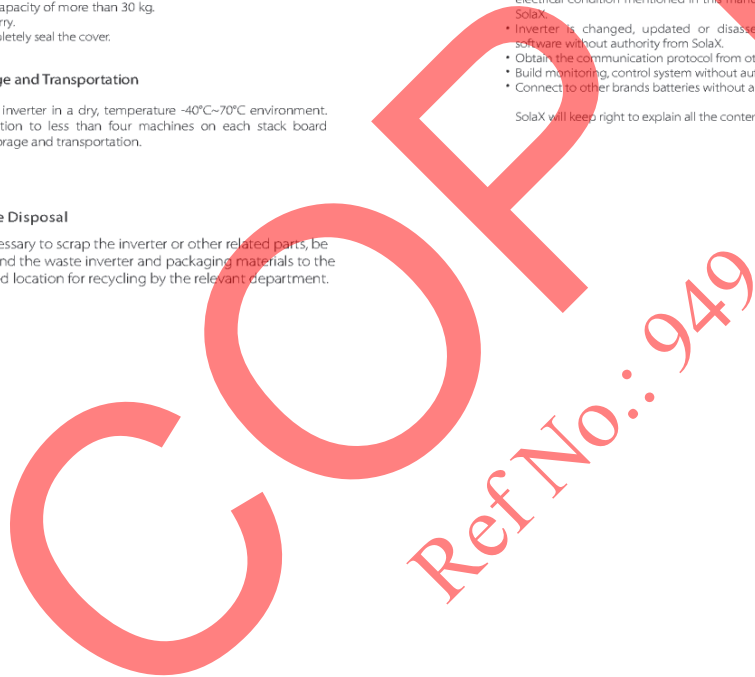



# Compliance Evaluation Report



REPORT No.: CSSC/BOS/012

ISSUED DATE: August 20, 2021

APPENDIX C. TÜV Rheinland's Report No: CN21ZH49 001.

Test Data / Test Plan		TÜVRheinland®	
TÜV Rheinland (Shanghai) Co., Ltd.		Document No.: TD-0189	
Protection and Control requirements for PEA Interface of Inverter based Generation Systems 2016.08		Report No:	CN21ZH49 001
Order No. :	244313300	Product:	Grid-Connected PV Inverter
Client Name :	SolaX Power Network Technology (Zhejiang)Co.,Ltd	Model designation:	X3-Hybrid-15.0
Issue Date:	2021.08.25	Project Engineer:	Allen Hu
Lab Target:	2021.08.25	Signature:	Allen Hu
<b>Electrical rating of the equipment:</b>			
Rated Input:	See appended rating label		
Rated Output:	See appended rating label		
Firmware version:	DSP1:2.07,DSP2:2.01,ARM:2.03		
Phase:	<input type="checkbox"/> Single-phase <input checked="" type="checkbox"/> Three-phase		
Protection class:	<input type="checkbox"/> Class 0 <input checked="" type="checkbox"/> Class I <input type="checkbox"/> Class II <input type="checkbox"/> Class III		
Overvoltage Category (OVC):	<input type="checkbox"/> OVC I <input checked="" type="checkbox"/> OVC II (PV) <input checked="" type="checkbox"/> OVC III (Mains) <input type="checkbox"/> OVC IV		
Pollution degree (PD):	<input type="checkbox"/> PD 1 <input checked="" type="checkbox"/> PD 2 (Inside) <input checked="" type="checkbox"/> PD 3 (Outside)		
Max. operating temperature:	See appended rating label		
<b>Documents attached:</b>		<b>Remark</b>	
<input checked="" type="checkbox"/>	Rating label	See following page.	
<input checked="" type="checkbox"/>	Product photo	See attachment 3.	
<input checked="" type="checkbox"/>	Test equipment list	See attachment 2.	
<input checked="" type="checkbox"/>	Wave diagram in test	See attachment 1.	

Used equipment No.: See equipment list for details      Sample No.: N/A

Finished date: \_\_\_\_\_      Tested by: \_\_\_\_\_

Review date: \_\_\_\_\_      Reviewed by: \_\_\_\_\_





# Compliance Evaluation Report



REPORT No.: CSSC/BOS/012

ISSUED DATE: August 20, 2021

APPENDIX C. TÜV Rheinland's Report No: CN21ZH49 001. (Cont.)

Test Data / Test Plan		TÜVRheinland®	
TÜV Rheinland (Shanghai) Co., Ltd.		Document No.:	TD-0189
Protection and Control requirements for PEA Interface of Inverter based Generation Systems 2016.08		Report No.:	CN21ZH49 001
Order No.:	244313300	Product:	Grid-Connected PV Inverter
Client Name:	SolaX Power Network Technology (Zhejiang)Co.,Ltd	Model designation:	X3-Hybrid-15.0

Content	Page No.
Rating label of EUT	4
General requirements and information for the tests	5
Requirements to the Measurement Precision of the Measuring Devices	8
Test results	10
Flicker	10
DC injection	12
Reactive Power Control	13
A Fixed Displacement Factor $\cos\phi$	14
Islanding Protection	16
Response to utility recovery	23
Over/Under voltage	24
Harmonic and waveform distortion	26
Over/Under Frequency	30
Active power control	31
Low voltage fault ride through	N/A
A variable reactive power depending on the voltage Q(U)	N/A
Attachment 1: Wave result	32
Islanding Protection	32
Response to utility recovery	88
Over Voltage Protection	100
Under Voltage Protection	116
Over Frequency Protection	132

Used equipment No.: See equipment list for details      Sample No.: N/A  
 Finished date: \_\_\_\_\_      Tested by: \_\_\_\_\_  
 Review date: \_\_\_\_\_      Reviewed by: \_\_\_\_\_



# Compliance Evaluation Report



REPORT No.: CSSC/BOS/012

ISSUED DATE: August 20, 2021

APPENDIX C. TÜV Rheinland's Report No: CN21ZH49 001. (Cont.)

Test Data / Test Plan		TÜVRheinland®	
TÜV Rheinland (Shanghai) Co., Ltd.		Document No.:	TD-0189
Protection and Control requirements for PEA Interface of Inverter based Generation Systems 2016.08		Report No.:	CN21ZH49 001
Order No.:	244313300	Product:	Grid-Connected PV Inverter
Client Name:	SolaX Power Network Technology (Zhejiang)Co.,Ltd	Model designation:	X3-Hybrid-15.0

Content	Page No.
Under Frequency Protection	133
Low voltage fault ride through	N/A
DC injection trend line	134
Active power control trend line	135
Attachment 2: Test equipment list	136
Attachment 3: EUT photo	137

Used equipment No.: See equipment list for details

Sample No.: N/A

Finished date: \_\_\_\_\_

Tested by: \_\_\_\_\_

Review date: \_\_\_\_\_

Reviewed by: \_\_\_\_\_

Page 3 of 139



# Compliance Evaluation Report



REPORT No.: CSSC/BOS/012

ISSUED DATE: August 20, 2021

APPENDIX C. TÜV Rheinland's Report No: CN21ZH49 001. (Cont.)

Test Data / Test Plan		TÜVRheinland®	
TÜV Rheinland (Shanghai) Co., Ltd.		Document No.: TD-0189	
Protection and Control requirements for PEA Interface of Inverter based Generation Systems 2016.08		Report No:	CN21ZH49 001
Order No. :	244313300	Product:	Grid-Connected PV Inverter
Client Name :	SolaX Power Network Technology (Zhejiang)Co.,Ltd	Model designation:	X3-Hybrid-15.0

Copy of marking plate:

**GRID SUPPORT UTILITY-INTERACTIVE TRANSFORMERLESS INVERTER**

Model: Inverter SN: X3-Hybrid-15.0

**DC INPUT/OUTPUT**

- Max. DC Voltage: 1000V
- MPE Voltage Range: 180-900V
- Max. DC Current (Impulse/Output): 24/20A
- Max. PV Input A/Output B: 30A/24A
- Battery Voltage Range: 180-650V
- Max. Charge and Discharge Current: 30A/30A

**AC INPUT/OUTPUT**

- Normal AC Voltage, Frequency: 310-400V/50/60Hz
- Max. Apparent AC Output Power: 15000VA
- Normal AC Input/Output Power: 20000/15000VA/4000W
- Max. AC Input/Output Current: 32.0/21.5A
- Power Factor Range: 0.8 leading - 0.8 lagging
- EPS Normal Voltage, Frequency: 400/230V/50/60Hz
- EPS Normal Apparent Power: 1500VA

**OTHERS**

- Operating Ambient Temperature Range: -35...50°C
- Ingress Protection: IP65
- Protection Class: I
- Over Voltage Category: II
- Safety: IEC60361-1/IEC60361-2
- Warning: VDE 0510/EN 60947-1/IEC 60947-1/IEC 60947-2/IEC 60947-3/IEC 60947-4/IEC 60947-5-1/IEC 60947-5-2/IEC 60947-5-3/IEC 60947-5-4/IEC 60947-5-5/IEC 60947-5-6/IEC 60947-5-7/IEC 60947-5-8/IEC 60947-5-9/IEC 60947-5-10/IEC 60947-5-11/IEC 60947-5-12/IEC 60947-5-13/IEC 60947-5-14/IEC 60947-5-15/IEC 60947-5-16/IEC 60947-5-17/IEC 60947-5-18/IEC 60947-5-19/IEC 60947-5-20/IEC 60947-5-21/IEC 60947-5-22/IEC 60947-5-23/IEC 60947-5-24/IEC 60947-5-25/IEC 60947-5-26/IEC 60947-5-27/IEC 60947-5-28/IEC 60947-5-29/IEC 60947-5-30/IEC 60947-5-31/IEC 60947-5-32/IEC 60947-5-33/IEC 60947-5-34/IEC 60947-5-35/IEC 60947-5-36/IEC 60947-5-37/IEC 60947-5-38/IEC 60947-5-39/IEC 60947-5-40/IEC 60947-5-41/IEC 60947-5-42/IEC 60947-5-43/IEC 60947-5-44/IEC 60947-5-45/IEC 60947-5-46/IEC 60947-5-47/IEC 60947-5-48/IEC 60947-5-49/IEC 60947-5-50/IEC 60947-5-51/IEC 60947-5-52/IEC 60947-5-53/IEC 60947-5-54/IEC 60947-5-55/IEC 60947-5-56/IEC 60947-5-57/IEC 60947-5-58/IEC 60947-5-59/IEC 60947-5-60/IEC 60947-5-61/IEC 60947-5-62/IEC 60947-5-63/IEC 60947-5-64/IEC 60947-5-65/IEC 60947-5-66/IEC 60947-5-67/IEC 60947-5-68/IEC 60947-5-69/IEC 60947-5-70/IEC 60947-5-71/IEC 60947-5-72/IEC 60947-5-73/IEC 60947-5-74/IEC 60947-5-75/IEC 60947-5-76/IEC 60947-5-77/IEC 60947-5-78/IEC 60947-5-79/IEC 60947-5-80/IEC 60947-5-81/IEC 60947-5-82/IEC 60947-5-83/IEC 60947-5-84/IEC 60947-5-85/IEC 60947-5-86/IEC 60947-5-87/IEC 60947-5-88/IEC 60947-5-89/IEC 60947-5-90/IEC 60947-5-91/IEC 60947-5-92/IEC 60947-5-93/IEC 60947-5-94/IEC 60947-5-95/IEC 60947-5-96/IEC 60947-5-97/IEC 60947-5-98/IEC 60947-5-99/IEC 60947-5-100

SolaX Power Network Technology (Zhejiang) Co., Ltd.  
 Add: No. 288 South Road, Siming Economic Development Zone, Songyang District, Taizhou City, Zhejiang Province, China  
 TEL: +86 571 8676 0001 E-mail: info@solaXpower.com  
 www.solaXpower.com MADE IN CHINA

Used equipment No.: See equipment list for details Sample No.: N/A

Finished date: \_\_\_\_\_ Tested by: \_\_\_\_\_

Review date: \_\_\_\_\_ Reviewed by: \_\_\_\_\_







# Compliance Evaluation Report



REPORT No.: CSSC/BOS/012

ISSUED DATE: August 20, 2021

APPENDIX C. TÜV Rheinland's Report No: CN21ZH49 001. (Cont.)

Test Data / Test Plan		TÜVRheinland®	
TÜV Rheinland (Shanghai) Co., Ltd.		Document No.: TD-0189	
Protection and Control requirements for PEA Interface of Inverter based Generation Systems 2016.08		Report No:	CN21ZH49 001
Order No.:	244313300	Product:	Grid-Connected PV Inverter
Client Name:	SolaX Power Network Technology (Zhejiang)Co.,Ltd	Model designation:	X3-Hybrid-15.0

Clause	Test description	Remark	Result
<input checked="" type="checkbox"/> 1.	Voltage and Frequency	Rating Voltage: 3/N/PE, 400V Rating Frequency: 50Hz	Pass
<input checked="" type="checkbox"/> 2.	Normal Voltage Operating Range	The EUT <sup>1)</sup> can run normally within voltage range $\pm 5\%U_n$ .	Pass
<input checked="" type="checkbox"/> 3.	Normal Frequency Operating Range	The EUT <sup>1)</sup> can run normally within frequency range $\pm 0.5\text{Hz}$ .	Pass
<input checked="" type="checkbox"/> 4.	Flicker	See appended table 4 for details.	Pass
<input checked="" type="checkbox"/> 5.	DC Injection	See appended table 5 for details.	Pass
<input checked="" type="checkbox"/> 6.	Reactive Power Control	See appended table 6 for details.	Pass
<input checked="" type="checkbox"/> 6.1	A Fixed Displacement Factor $\cos\phi$	See appended table 6.1 for details.	Pass
<input checked="" type="checkbox"/> 7.	Islanding Protection	See appended table 7 for details.	Pass
<input checked="" type="checkbox"/> 8.	Response to utility recovery	See appended table 8 for details.	Pass
<input checked="" type="checkbox"/> 9.	Over/Under voltage	See appended table 9 for details.	Pass
<input checked="" type="checkbox"/> 10.	Harmonic and waveform distortion	See appended table 10 for details.	Pass
<input checked="" type="checkbox"/> 11.	Over/Under Frequency	See appended table 11 for details.	Pass
<input checked="" type="checkbox"/> 12.	Active Power Control	See appended table 12 for details.	Pass
<input checked="" type="checkbox"/> 13.	Low voltage fault ride through	See appended table 13 for details.	N/A
<input checked="" type="checkbox"/> 14.	A variable reactive power depending on the voltage Q(U)	See appended table 14 for details.	N/A
<input checked="" type="checkbox"/> 15.	Earthing	Protective equipotential bonding conductors are installed, where they are parallel to and in close contact with d.c. cables and a.c. cables and accessories.	Pass
<input checked="" type="checkbox"/> 16.	Short circuit	Circuit breakers need to be installed additionally at both input	Pass

Used equipment No.: See equipment list for details      Sample No.: N/A  
 Finished date: \_\_\_\_\_      Tested by: \_\_\_\_\_  
 Review date: \_\_\_\_\_      Reviewed by: \_\_\_\_\_



# Compliance Evaluation Report



REPORT No.: CSSC/BOS/012

ISSUED DATE: August 20, 2021

APPENDIX C. TÜV Rheinland's Report No: CN21ZH49 001. (Cont.)

Test Data / Test Plan		TÜVRheinland®																											
TÜV Rheinland (Shanghai) Co., Ltd.		Document No.: TD-0189																											
Protection and Control requirements for PEA Interface of Inverter based Generation Systems 2016.08		Report No:	CN21ZH49 001																										
Order No.:	244313300	Product:	Grid-Connected PV Inverter																										
Client Name:	SolaX Power Network Technology (Zhejiang)Co.,Ltd	Model designation:	X3-Hybrid-15.0																										
Clause	Test description	Remark	Result																										
		and output end to protect the PV and a.c. supply cables from the effects of short circuit.																											
<input checked="" type="checkbox"/> 17.	Isolating and switching	Circuit breakers need to be installed on both d.c. and a.c. sides to provide the means of isolating.	Pass.																										
<input checked="" type="checkbox"/> 18.	Inverter Testing Procedure/Method	Test methods in below table are all complied.	Pass																										
	<table border="1"> <thead> <tr> <th>Item</th> <th>Test Procedure/Method</th> </tr> </thead> <tbody> <tr> <td>Harmonics Test</td> <td>IEEE or IEC related standard</td> </tr> <tr> <td>Voltage Fluctuation Test</td> <td>IEEE or IEC related standard</td> </tr> <tr> <td>DC Injection Test</td> <td>IEEE or IEC related standard</td> </tr> <tr> <td>Reactive Power Control</td> <td>Requirements of PEA</td> </tr> <tr> <td>A Fixed Displacement Factor</td> <td>Requirements of PEA</td> </tr> <tr> <td>A variable Reactive Power Depending On the Voltage Q(U)</td> <td>Requirements of PEA</td> </tr> <tr> <td>Active Power Control Test</td> <td>Requirements of PEA</td> </tr> <tr> <td>Low Voltage Fault Ride Through Test</td> <td>Requirements of PEA</td> </tr> <tr> <td>Under and Over Voltage Protection</td> <td>Requirements of PEA</td> </tr> <tr> <td>Under and Over Frequency Protection</td> <td>Requirements of PEA</td> </tr> <tr> <td>Anti-islanding Protection Test</td> <td>IEEE or IEC related standard</td> </tr> <tr> <td>Response to Utility Recovery Test</td> <td>IEEE or IEC related standard</td> </tr> </tbody> </table>	Item	Test Procedure/Method	Harmonics Test	IEEE or IEC related standard	Voltage Fluctuation Test	IEEE or IEC related standard	DC Injection Test	IEEE or IEC related standard	Reactive Power Control	Requirements of PEA	A Fixed Displacement Factor	Requirements of PEA	A variable Reactive Power Depending On the Voltage Q(U)	Requirements of PEA	Active Power Control Test	Requirements of PEA	Low Voltage Fault Ride Through Test	Requirements of PEA	Under and Over Voltage Protection	Requirements of PEA	Under and Over Frequency Protection	Requirements of PEA	Anti-islanding Protection Test	IEEE or IEC related standard	Response to Utility Recovery Test	IEEE or IEC related standard		
Item	Test Procedure/Method																												
Harmonics Test	IEEE or IEC related standard																												
Voltage Fluctuation Test	IEEE or IEC related standard																												
DC Injection Test	IEEE or IEC related standard																												
Reactive Power Control	Requirements of PEA																												
A Fixed Displacement Factor	Requirements of PEA																												
A variable Reactive Power Depending On the Voltage Q(U)	Requirements of PEA																												
Active Power Control Test	Requirements of PEA																												
Low Voltage Fault Ride Through Test	Requirements of PEA																												
Under and Over Voltage Protection	Requirements of PEA																												
Under and Over Frequency Protection	Requirements of PEA																												
Anti-islanding Protection Test	IEEE or IEC related standard																												
Response to Utility Recovery Test	IEEE or IEC related standard																												
Remark: Additional transformer should be installed while connected to medium voltage grid.																													

Used equipment No.: See equipment list for details

Sample No.: N/A

Finished date:

Tested by:

Review date:

Reviewed by:





# Compliance Evaluation Report



REPORT No.: CSSC/BOS/012

ISSUED DATE: August 20, 2021

APPENDIX C. TÜV Rheinland's Report No: CN21ZH49 001. (Cont.)

Test Data / Test Plan			
TÜV Rheinland (Shanghai) Co., Ltd.		Document No.:	TD-0189
Protection and Control requirements for PEA Interface of Inverter based Generation Systems 2016.08		Report No.:	CN21ZH49 001
Order No.:	244313300	Product:	Grid-Connected PV Inverter
Client Name:	SolaX Power Network Technology (Zhejiang)Co.,Ltd	Model designation:	X3-Hybrid-15.0

*Special notice to test engineer:*

Please contact and communicate with project engineer immediately when any of the following conditions occurred:

- Unclear of the test operating conditions and test items,
- Uncertain of the test requirements or possible typing errors found in the test plan,
- Unusual operating conditions of the EUT (unusual noises, unstable operation, ...etc), any unusual phenomenon of the operation that attracts your attention,
- Receive different model/type name of samples that does not match to the test plan,
- Short of the test samples,
- Unusual high temperatures observed during testing,
- Enclosure distortion, cracks, or loosening of any enclosure parts observed during testing, and
- Fire occurred within the EUT during testing

Handling of test samples after completed all tests:

- Store in warehouse and wait for further notice
- Return to project engineer
- Dispose test samples according to current lab procedures
- Return to the client

Used equipment No.: See equipment list for details

Sample No.: N/A

Finished date: \_\_\_\_\_

Tested by: \_\_\_\_\_

Review date: \_\_\_\_\_

Reviewed by: \_\_\_\_\_

Page 7 of 139



# Compliance Evaluation Report



REPORT No.: CSSC/BOS/012

ISSUED DATE: August 20, 2021

APPENDIX C. TÜV Rheinland's Report No: CN21ZH49 001. (Cont.)

Test Data / Test Plan		TÜVRheinland®	
TÜV Rheinland (Shanghai) Co., Ltd.		Document No.: TD-0189	
Protection and Control requirements for PEA Interface of Inverter based Generation Systems 2016.08		Report No:	CN21ZH49 001
Order No.:	244313300	Product:	Grid-Connected PV Inverter
Client Name:	SolaX Power Network Technology (Zhejiang)Co.,Ltd	Model designation:	X3-Hybrid-15.0

## Requirements to the Measurement Precision of the Measuring Devices

The used measuring devices must fulfill at least the following measuring precisions.

### Minimum measuring precisions

Measured Variable	Frequency Range	Measuring Precision relative to the Measuring Range
Voltage up to 1 000 V	50 Hz	± 0.1 %
	DC to 1 kHz (except for 50 Hz)	± 1.0 %
	1 kHz to < 5 kHz	± 1.5 %
	5 kHz to < 20 kHz	± 2.5 %
	≥ 20 kHz	± 5.0 %
Current < 5A	50 Hz	± 0.5 %
	DC to < 60 Hz (except for 50 Hz)	± 1.0 %
	60 Hz to < 5 kHz	± 1.5 %
	5 kHz to < 20 kHz	± 2.5 %
Current > 5A	50 Hz	± 0.5 %
	≥ 20 kHz (except for 50 Hz)	± 5.0 %
	DC to < 5 kHz	± 1.5 %
	5 kHz to < 20 kHz	± 3.5 %
Frequency	≥ 20 kHz	± 5.0 %
	DC to < 60 Hz	± 0.01 Hz
	60 Hz to 5 kHz	± 0.2 %
	5 kHz to < 20 kHz	± 0.5 %
Displacement Factor $\cos\varphi$		± 1 %
		0.001
Time		
	10 ms to < 200 ms	± 5 % of the measured value
	200 ms to < 1 s	± 10 ms
Temperature	≥ 1 s	± 1 % of the measured value
	> -35°C to 100°C	± 2°C

Used equipment No.: See equipment list for details

Sample No.: N/A

Finished date:

Tested by:

Review date:

Reviewed by:



# Compliance Evaluation Report



REPORT No.: CSSC/BOS/012

ISSUED DATE: August 20, 2021

APPENDIX C. TÜV Rheinland's Report No: CN21ZH49 001. (Cont.)

Test Data / Test Plan		TÜVRheinland®	
TÜV Rheinland (Shanghai) Co., Ltd.		Document No.: TD-0189	
Protection and Control requirements for PEA Interface of Inverter based Generation Systems 2016.08		Report No:	CN21ZH49 001
Order No.:	244313300	Product:	Grid-Connected PV Inverter
Client Name:	SolaX Power Network Technology (Zhejiang)Co.,Ltd	Model designation:	X3-Hybrid-15.0

Measured Variable	Frequency Range	Measuring Precision relative to the Measuring Range
Relative humidity	30 % to 95 % RH	± 6 % RH
Barometric air pressure		± 10 kPa

The selected measuring range must not be bigger than 150% of the nominal value of the signal to be measured.

Source: CTL Decision Sheet DHS251B / 2009, modified

### Revision History:

Date YYYY-MM-DD	Contents of modification	Prepared by	Approved by
2019-02-04	Original Test Plan	Tobias Yang	Li Weichun
2019-06-05	Modified Test Plan	Tobias Yang	Li Weichun

Used equipment No.: See equipment list for details

Sample No.: N/A

Finished date:

Tested by:

Review date:

Reviewed by:



# Compliance Evaluation Report



REPORT No.: CSSC/BOS/012

ISSUED DATE: August 20, 2021

APPENDIX C. TÜV Rheinland's Report No: CN21ZH49 001. (Cont.)

Test Data / Test Plan		TÜVRheinland®	
TÜV Rheinland (Shanghai) Co., Ltd.		Document No.: TD-0189	
Protection and Control requirements for PEA Interface of Inverter based Generation Systems 2016.08		Report No:	CN21ZH49 001
Order No.:	244313300	Product:	Grid-Connected PV Inverter
Client Name :	SolaX Power Network Technology (Zhejiang)Co.,Ltd	Model designation:	X3-Hybrid-15.0

## 4. Flicker

### PROCEDURE

Test method complies with standard IEC 61000-3-3 or IEC 61000-3-11.

RESULTS  Pass /  Fail

4		TABLE: Flicker			P	
Mains voltage: $V_{\phi-n}=220V, V_{\phi-\phi}=380V$						
Reference Impedance used: $L=0.15+0.15j, N=0.1+0.1j$						
Phase A	Measurement	Pst		0.42		
		Limit		0.65		
	1	Pst	0.46	0.26	0.55	0
		Limit= 1.0		Limit= 3.3	Limit= 4.0	Limit= 500
	2	Pst	0.57	0.21	2.01	0
		Pst	0.42	0.22	0.56	0
	3	Pst	0.49	0.20	1.17	0
		Pst	0.44	0.22	1.17	0
	4	Pst	0.52	0.24	2.23	0
		Pst	0.36	0.21	2.23	0
	5	Pst	0.44	0.18	0.69	0
		Pst	0.45	0.17	0.89	0
	6	Pst	0.13	0.25	0.74	0
Pst		0.11	0.20	0.23	0	
7	Pst	0.12	0.25	0.30	0	

Phase B	Measurement	Pst		0.40		
		Limit		0.65		
	1	Pst	0.43	0.23	0.46	0
		Limit= 1.0		Limit= 3.3	Limit= 4.0	Limit= 500
	2	Pst	0.53	0.18	2.09	0
Pst		0.40	0.21	0.48	0	
3	Pst	0.48	0.32	1.08	0	

Used equipment No.: See equipment list for details Sample No.: N/A

Finished date: \_\_\_\_\_ Tested by: \_\_\_\_\_

Review date: \_\_\_\_\_ Reviewed by: \_\_\_\_\_





# Compliance Evaluation Report



REPORT No.: CSSC/BOS/012

ISSUED DATE: August 20, 2021

APPENDIX C. TÜV Rheinland's Report No: CN21ZH49 001. (Cont.)

<b>Test Data / Test Plan</b>			
TÜV Rheinland (Shanghai) Co., Ltd.		Document No.: TD-0189	
Protection and Control requirements for PEA Interface of Inverter based Generation Systems 2016.08		Report No:	CN21ZH49 001
Order No.:	244313300	Product:	Grid-Connected PV Inverter
Client Name :	SolaX Power Network Technology (Zhejiang)Co.,Ltd	Model designation:	X3-Hybrid-15.0

Phase C	5	0.42	0.22	0.48	0	
	6	0.47	0.14	2.03	0	
	7	0.35	0.16	0.40	0	
	8	0.42	0.14	0.68	0	
	9	0.43	0.14	0.67	0	
	10	0.12	0.07	0.63	0	
	11	0.10	0.09	0.25	0	
	12	0.10	0.00	0.00	0	
	Measurement	Pll		0.43		
		Limit		0.65		
		Pst	dc(%)	dmax(%)	d(f) (ms)	
		Limit= 1.0	Limit= 3.3	Limit= 4.0	Limit= 500	
	1	0.49	0.15	0.46	0	
2	0.58	0.14	2.40	0		
3	0.44	0.19	0.49	0		
4	0.53	0.18	1.04	0		
5	0.45	0.30	0.58	0		
6	0.49	0.13	2.29	0		
7	0.34	0.14	0.38	0		
8	0.44	0.16	0.39	0		
9	0.44	0.19	0.80	0		
10	0.11	0.12	0.19	0		
11	0.10	0.00	0.00	0		
12	0.10	0.06	0.13	0		

Used equipment No.: See equipment list for details Sample No.: N/A

Finished date: \_\_\_\_\_ Tested by: \_\_\_\_\_

Review date: \_\_\_\_\_ Reviewed by: \_\_\_\_\_





# Compliance Evaluation Report



REPORT No.: CSSC/BOS/012

ISSUED DATE: August 20, 2021

APPENDIX C. TÜV Rheinland's Report No: CN21ZH49 001. (Cont.)

Test Data / Test Plan		TÜVRheinland®	
TÜV Rheinland (Shanghai) Co., Ltd.		Document No.: TD-0189	
Protection and Control requirements for PEA Interface of Inverter based Generation Systems 2016.08		Report No:	CN21ZH49 001
Order No.:	244313300	Product:	Grid-Connected PV Inverter
Client Name:	SolaX Power Network Technology (Zhejiang)Co.,Ltd	Model designation:	X3-Hybrid-15.0

## 5. DC Injection

### PROCEDURE

The test methods complies with standard IEEE 1547.1-2005 clause 5.6

RESULTS  Pass /  Fail

5	TABLE: DC Injection							P
Mains voltage: $V_{\phi-n}=220V, V_{\phi-\phi}=380V$								
PowerP/Pn[%]		100%						
Measurement							Limit	
Phase A		Phase B		Phase C				
[A]	[%]	[A]	[%]	[A]	[%]	[A]	[%]	
0.007	0.03	0.007	0.03	0.003	0.01	0.106	0.5	
PowerP/Pn[%]		66%						
Measurement							Limit	
Phase A		Phase B		Phase C				
[A]	[%]	[A]	[%]	[A]	[%]	[A]	[%]	
0.009	0.04	0.010	0.05	0.007	0.03	0.106	0.5	
PowerP/Pn[%]		33%						
Measurement							Limit	
Phase A		Phase B		Phase C				
[A]	[%]	[A]	[%]	[A]	[%]	[A]	[%]	
0.009	0.04	0.013	0.06	0.008	0.04	0.106	0.5	
Remark: The absolute average value on 5mins have been taken.								

Used equipment No.: See equipment list for details

Sample No.: N/A

Finished date:

Tested by:

Review date:

Reviewed by:





# Compliance Evaluation Report



REPORT No.: CSSC/BOS/012

ISSUED DATE: August 20, 2021

APPENDIX C. TÜV Rheinland's Report No: CN21ZH49 001. (Cont.)

<b>Test Data / Test Plan</b>			
TÜV Rheinland (Shanghai) Co., Ltd.		Document No.: TD-0189	
Protection and Control requirements for PEA Interface of Inverter based Generation Systems 2016.08		Report No:	CN21ZH49 001
Order No.:	244313300	Product:	Grid-Connected PV Inverter
Client Name:	SolaX Power Network Technology (Zhejiang)Co.,Ltd	Model designation:	X3-Hybrid-15.0

## 6. Reactive Power Control

### PROCEDURE

The test methods complies with standard Protection and Control requirements for PEA Interface of Inverter based Generation Systems 2016

RESULTS  Pass /  Fail

6.		TABLE: Power Factor Control					P	
Mains voltage: $V_{\phi-n}=220V, V_{\phi-\phi}=380V$								
P Set value	P [W]	Max. $\cos\phi$ lagging	Q [Var]	P Set value	P [W]	Max. $\cos\phi$ leading	Q [Var]	
0%	396.76	0.079	-5027.82	0%	328.02	0.065	5045.51	
10%	1528.79	0.291	-5029.41	10%	1461.97	0.278	5043.33	
20%	2923.62	0.502	-5032.70	20%	2873.64	0.495	5038.57	
30%	4361.66	0.655	-5032.40	30%	4295.17	0.649	5036.91	
40%	5778.33	0.754	-5034.30	40%	5713.12	0.750	5034.22	
50%	7194.45	0.819	-5036.92	50%	7129.28	0.817	5032.07	
60%	8611.68	0.863	-5040.36	60%	8547.48	0.862	5030.50	
70%	10027.77	0.893	-5043.57	70%	9963.42	0.893	5028.37	
80%	11444.61	0.915	-5047.21	80%	11379.37	0.915	5029.42	
90%	12717.71	0.929	-5048.76	90%	12652.82	0.929	5032.77	
100%	14127.46	0.942	-5048.92	100%	14058.61	0.941	5034.62	

Used equipment No.: See equipment list for details

Sample No.: N/A

Finished date:

Tested by:

Review date:

Reviewed by:





# Compliance Evaluation Report



REPORT No.: CSSC/BOS/012

ISSUED DATE: August 20, 2021

APPENDIX C. TÜV Rheinland's Report No: CN21ZH49 001. (Cont.)

Test Data / Test Plan		TÜVRheinland®	
TÜV Rheinland (Shanghai) Co., Ltd.		Document No.: TD-0189	
Protection and Control requirements for PEA Interface of Inverter based Generation Systems 2016.08		Report No:	CN21ZH49 001
Order No.:	244313300	Product:	Grid-Connected PV Inverter
Client Name:	SolaX Power Network Technology (Zhejiang)Co.,Ltd	Model designation:	X3-Hybrid-15.0

## 6.1. A fixed displacement factor $\cos\phi$

### PROCEDURE

The test methods complies with standard Protection and Control requirements for PEA Interface of Inverter based Generation Systems 2016.

6.1 TABLE: A fixed displacement factor $\cos\phi$								P
Mains voltage: $V_{\phi-n}=220V, V_{\phi-\phi}=380V$								
P Set value	$\cos\phi$ Set value	P [W]	Q [Var]	$\cos\phi$	$\cos\phi$ Set value	P [W]	Q [Var]	$\cos\phi$
0%	0.95 lagging	343.78	-158.29	0.907	0.95 leading	341.97	173.18	0.892
10%	0.95 lagging	1488.35	-545.50	0.939	0.95 leading	1481.12	550.02	0.937
20%	0.95 lagging	2912.13	-907.00	0.940	0.95 leading	2897.96	1069.08	0.938
30%	0.95 lagging	4332.37	-1573.53	0.940	0.95 leading	4311.70	1580.67	0.939
40%	0.95 lagging	5754.07	-2088.93	0.940	0.95 leading	5727.36	2089.78	0.939
50%	0.95 lagging	7176.52	-2607.80	0.940	0.95 leading	7143.31	2598.62	0.940
60%	0.95 lagging	8563.43	-3113.85	0.940	0.95 leading	8557.59	3106.69	0.940
70%	0.95 lagging	10022.34	-3647.08	0.940	0.95 leading	9960.13	3612.20	0.940
80%	0.95 lagging	11424.08	-4158.83	0.940	0.95 leading	11368.34	4123.10	0.940
90%	0.95 lagging	12696.54	-4623.31	0.940	0.95 leading	12637.57	4591.49	0.940
100%	0.95 lagging	14065.62	-5121.17	0.940	0.95 leading	14050.90	5104.14	0.940

Used equipment No.: See equipment list for details

Sample No.: N/A

Finished date:

Tested by:

Review date:

Reviewed by:



# Compliance Evaluation Report



REPORT No.: CSSC/BOS/012

ISSUED DATE: August 20, 2021

APPENDIX C. TÜV Rheinland's Report No: CN21ZH49 001. (Cont.)

Test Data / Test Plan		TÜVRheinland®	
TÜV Rheinland (Shanghai) Co., Ltd.		Document No.: TD-0189	
Protection and Control requirements for PEA Interface of Inverter based Generation Systems 2016.08		Report No:	CN21ZH49 001
Order No. :	244313300	Product:	Grid-Connected PV Inverter
Client Name :	SolaX Power Network Technology (Zhejiang)Co.,Ltd	Model designation:	X3-Hybrid-15.0

P Set value	Cosφ Set value	P [W]	Q [Var]	Cosφ			
0%	1.00	343.22	107.33	0.954			
10%	1.00	1484.68	110.26	0.997			
20%	1.00	2905.36	123.68	0.999			
30%	1.00	4321.96	154.64	0.999			
40%	1.00	5742.15	189.30	0.999			
50%	1.00	7159.67	229.81	0.999			
60%	1.00	8577.01	267.13	1.000			
70%	1.00	9973.38	313.04	1.000			
80%	1.00	11402.93	400.41	0.999			
90%	1.00	12805.78	487.75	0.999			
100%	1.00	14027.03	506.46	0.999			

Used equipment No.: See equipment list for details

Sample No.: N/A

Finished date:

Tested by:

Review date:

Reviewed by:





# Compliance Evaluation Report



REPORT No.: CSSC/BOS/012

ISSUED DATE: August 20, 2021

APPENDIX C. TÜV Rheinland's Report No: CN21ZH49 001. (Cont.)

Test Data / Test Plan		TÜVRheinland®	
TÜV Rheinland (Shanghai) Co., Ltd.		Document No.: TD-0189	
Protection and Control requirements for PEA Interface of Inverter based Generation Systems 2016.08		Report No:	CN21ZH49 001
Order No.:	244313300	Product:	Grid-Connected PV Inverter
Client Name:	SolaX Power Network Technology (Zhejiang)Co.,Ltd	Model designation:	X3-Hybrid-15.0

## 7. Islanding Protection

### PROCEDURE

Test methods complies with standard IEC 62116.

RESULTS  Pass /  Fail

7	TABLE: Islanding Protection					P
Mains voltage: $V_{\varphi-n}=220V, V_{\varphi-\varphi}=380V$						
Power 100%						
Conditions	$P_R$ [kW]	$Q_L$ [kVar]	$Q_C$ [kVar]	$Q_f$	Trip time [ms]	Limitation [ms]
Pr: -10% Ql: +10%	L1: 4.30	L1: 5.28	L1: 4.83	1.17	84	1000
	L2: 4.27	L2: 5.24	L2: 4.80	1.18		
	L3: 4.27	L3: 5.26	L3: 4.78	1.17		
Pr: -10% Ql: +5%	L1: 4.30	L1: 5.04	L1: 4.83	1.15	86	1000
	L2: 4.27	L2: 5.00	L2: 4.80	1.15		
	L3: 4.27	L3: 5.02	L3: 4.78	1.15		
Pr: -10% Ql: 0%	L1: 4.30	L1: 4.80	L1: 4.83	1.12	97	1000
	L2: 4.27	L2: 4.76	L2: 4.80	1.12		
	L3: 4.27	L3: 4.78	L3: 4.78	1.12		
Pr: -10% Ql: -5%	L1: 4.30	L1: 4.56	L1: 4.83	1.09	101	1000
	L2: 4.27	L2: 4.53	L2: 4.80	1.09		
	L3: 4.27	L3: 4.54	L3: 4.78	1.09		
Pr: -10% Ql: -10%	L1: 4.30	L1: 4.32	L1: 4.83	1.06	103	1000
	L2: 4.27	L2: 4.29	L2: 4.80	1.06		
	L3: 4.27	L3: 4.30	L3: 4.78	1.06		

Used equipment No.: See equipment list for details

Sample No.: N/A

Finished date:

Tested by:

Review date:

Reviewed by:





# Compliance Evaluation Report



REPORT No.: CSSC/BOS/012

ISSUED DATE: August 20, 2021

APPENDIX C. TÜV Rheinland's Report No: CN21ZH49 001. (Cont.)

Test Data / Test Plan					TÜVRheinland®	
TÜV Rheinland (Shanghai) Co., Ltd.			Document No.: TD-0189			
Protection and Control requirements for PEA Interface of Inverter based Generation Systems 2016.08			Report No:		CN21ZH49 001	
Order No.:		244313300		Product:		Grid-Connected PV Inverter
Client Name:		SolaX Power Network Technology (Zhejiang)Co.,Ltd		Model designation:		X3-Hybrid-15.0

PR: -5% QL: +10%	L1: 4.54	L1: 5.28	L1: 4.83	1.11	108	1000
	L2: 4.50	L2: 5.24	L2: 4.80	1.11		
	L3: 4.51	L3: 5.26	L3: 4.78	1.11		
PR: -5% QL: -10%	L1: 4.54	L1: 4.32	L1: 4.83	1.01	109	1000
	L2: 4.50	L2: 4.29	L2: 4.80	1.01		
	L3: 4.51	L3: 4.30	L3: 4.78	1.01		
PR: 0% QL: +10%	L1: 4.78	L1: 5.28	L1: 4.83	1.06	110	1000
	L2: 4.74	L2: 5.24	L2: 4.80	1.06		
	L3: 4.75	L3: 5.26	L3: 4.78	1.06		
PR: -5% QL: +5%	L1: 4.54	L1: 5.04	L1: 4.83	1.09	116	1000
	L2: 4.50	L2: 5.00	L2: 4.80	1.09		
	L3: 4.51	L3: 5.02	L3: 4.78	1.09		
PR: -5% QL: 0%	L1: 4.54	L1: 4.80	L1: 4.83	1.06	139	1000
	L2: 4.50	L2: 4.76	L2: 4.80	1.06		
	L3: 4.51	L3: 4.78	L3: 4.78	1.06		
PR: -5% QL: -5%	L1: 4.54	L1: 4.56	L1: 4.83	1.03	247	1000
	L2: 4.50	L2: 4.53	L2: 4.80	1.04		
	L3: 4.51	L3: 4.54	L3: 4.78	1.03		
PR: 0% QL: +5%	L1: 4.78	L1: 5.04	L1: 4.83	1.03	307	1000
	L2: 4.74	L2: 5.00	L2: 4.80	1.03		
	L3: 4.75	L3: 5.02	L3: 4.78	1.03		
PR: 0% QL: 0%	L1: 4.78	L1: 4.80	L1: 4.83	1.01	325	1000
	L2: 4.74	L2: 4.76	L2: 4.80	1.01		

Used equipment No.: See equipment list for details

Sample No.: N/A

Finished date:

Tested by:

Review date:

Reviewed by:





# Compliance Evaluation Report



REPORT No.: CSSC/BOS/012

ISSUED DATE: August 20, 2021

APPENDIX C. TÜV Rheinland's Report No: CN21ZH49 001. (Cont.)

Test Data / Test Plan		TÜVRheinland®	
TÜV Rheinland (Shanghai) Co., Ltd.		Document No.: TD-0189	
Protection and Control requirements for PEA Interface of Inverter based Generation Systems 2016.08		Report No:	CN21ZH49 001
Order No.:	244313300	Product:	Grid-Connected PV Inverter
Client Name:	SolaX Power Network Technology (Zhejiang)Co.,Ltd	Model designation:	X3-Hybrid-15.0

Pr: 0% Ql: -5%	L3: 4.75	L3: 4.78	L3: 4.78	1.01	298	1000
	L1: 4.78	L1: 4.56	L1: 4.83	0.98		
	L2: 4.74	L2: 4.53	L2: 4.80	0.98		
Pr: +5% Ql: +5%	L3: 4.75	L3: 4.54	L3: 4.78	0.98	221	1000
	L1: 5.02	L1: 5.04	L1: 4.83	0.98		
	L2: 4.98	L2: 5.00	L2: 4.80	0.98		
Pr: +5% Ql: 0%	L3: 4.98	L3: 5.02	L3: 4.78	0.98	146	1000
	L1: 5.02	L1: 4.80	L1: 4.83	0.96		
	L2: 4.98	L2: 4.76	L2: 4.80	0.96		
Pr: +5% Ql: -5%	L3: 4.98	L3: 4.78	L3: 4.78	0.96	119	1000
	L1: 5.02	L1: 4.56	L1: 4.83	0.94		
	L2: 4.98	L2: 4.53	L2: 4.80	0.94		
Pr: 0% Ql: -10%	L3: 4.98	L3: 4.54	L3: 4.78	0.93	115	1000
	L1: 4.78	L1: 4.32	L1: 4.83	0.96		
	L2: 4.74	L2: 4.29	L2: 4.80	0.96		
Pr: +5% Ql: +10%	L3: 4.75	L3: 4.30	L3: 4.78	0.96	110	1000
	L1: 5.02	L1: 5.28	L1: 4.83	1.01		
	L2: 4.98	L2: 5.24	L2: 4.80	1.01		
Pr: +5% Ql: -10%	L3: 4.98	L3: 5.26	L3: 4.78	1.01	108	1000
	L1: 5.02	L1: 4.32	L1: 4.83	0.91		
	L2: 4.98	L2: 4.29	L2: 4.80	0.91		
Pr: +10% Ql: +10%	L3: 4.98	L3: 4.30	L3: 4.78	0.91	108	1000
	L1: 5.25	L1: 5.28	L1: 4.83	0.96		
	L2: 5.22	L2: 5.24	L2: 4.80	0.96		

Used equipment No.: See equipment list for details Sample No.: N/A  
 Finished date: \_\_\_\_\_ Tested by: \_\_\_\_\_  
 Review date: \_\_\_\_\_ Reviewed by: \_\_\_\_\_





# Compliance Evaluation Report



REPORT No.: CSSC/BOS/012

ISSUED DATE: August 20, 2021

APPENDIX C. TÜV Rheinland's Report No: CN21ZH49 001. (Cont.)

Test Data / Test Plan		TÜVRheinland®	
TÜV Rheinland (Shanghai) Co., Ltd.		Document No.: TD-0189	
Protection and Control requirements for PEA Interface of Inverter based Generation Systems 2016.08		Report No:	CN21ZH49 001
Order No.:	244313300	Product:	Grid-Connected PV Inverter
Client Name:	SolaX Power Network Technology (Zhejiang)Co.,Ltd	Model designation:	X3-Hybrid-15.0

Pr: +10% Ql: +5%	L3:	5.22	L3:	5.26	L3:	4.78	0.96	105	1000
	L1:	5.25	L1:	5.04	L1:	4.83	0.94		
	L2:	5.22	L2:	5.00	L2:	4.80	0.94		
	L3:	5.22	L3:	5.02	L3:	4.78	0.94		
Pr: +10% Ql: 0%	L1:	5.25	L1:	4.80	L1:	4.83	0.92	103	1000
	L2:	5.22	L2:	4.76	L2:	4.80	0.92		
	L3:	5.22	L3:	4.78	L3:	4.78	0.92		
Pr: +10% Ql: -5%	L1:	5.25	L1:	4.56	L1:	4.83	0.89	100	1000
	L2:	5.22	L2:	4.53	L2:	4.80	0.89		
	L3:	5.22	L3:	4.54	L3:	4.78	0.89		
Pr: +10% Ql: -10%	L1:	5.25	L1:	4.32	L1:	4.83	0.87	88	1000
	L2:	5.22	L2:	4.29	L2:	4.80	0.87		
	L3:	5.22	L3:	4.30	L3:	4.78	0.87		
Power 66%									
Conditions	Pr [kW]	Ql [kVar]	Qc [kVar]	Qr	Trip time [ms]	Limitation [ms]			
Pr: 0% Ql: -5%	L1:	3.26	L1:	3.07	L1:	3.24	0.97	131	1000
	L2:	3.27	L2:	3.09	L2:	3.28	0.97		
	L3:	3.30	L3:	3.19	L3:	3.24	0.97		
Pr: 0% Ql: -4%	L1:	3.26	L1:	3.11	L1:	3.24	0.97	141	1000
	L2:	3.27	L2:	3.13	L2:	3.28	0.98		
	L3:	3.30	L3:	3.22	L3:	3.24	0.98		
Pr: 0% Ql: -3%	L1:	3.26	L1:	3.14	L1:	3.24	0.98	192	1000
	L2:	3.27	L2:	3.16	L2:	3.28	0.98		
	L3:	3.30	L3:	3.25	L3:	3.24	0.99		

Used equipment No.: See equipment list for details Sample No.: N/A  
 Finished date: \_\_\_\_\_ Tested by: \_\_\_\_\_  
 Review date: \_\_\_\_\_ Reviewed by: \_\_\_\_\_





# Compliance Evaluation Report



REPORT No.: CSSC/BOS/012

ISSUED DATE: August 20, 2021

APPENDIX C. TÜV Rheinland's Report No: CN21ZH49 001. (Cont.)

Test Data / Test Plan		TÜVRheinland®	
TÜV Rheinland (Shanghai) Co., Ltd.		Document No.: TD-0189	
Protection and Control requirements for PEA Interface of Inverter based Generation Systems 2016.08		Report No:	CN21ZH49 001
Order No.:	244313300	Product:	Grid-Connected PV Inverter
Client Name:	SolaX Power Network Technology (Zhejiang)Co.,Ltd	Model designation:	X3-Hybrid-15.0

PR: 0% QL: -2%	L1: 3.26	L1: 3.17	L1: 3.24	0.98	301	1000
	L2: 3.27	L2: 3.19	L2: 3.28	0.99		
	L3: 3.30	L3: 3.29	L3: 3.24	0.99		
PR: 0% QL: -1%	L1: 3.26	L1: 3.20	L1: 3.24	0.99	386	1000
	L2: 3.27	L2: 3.22	L2: 3.28	0.99		
	L3: 3.30	L3: 3.32	L3: 3.24	1.00		
PR: 0% QL: 0%	L1: 3.26	L1: 3.24	L1: 3.24	0.99	452	1000
	L2: 3.27	L2: 3.26	L2: 3.28	1.00		
	L3: 3.30	L3: 3.36	L3: 3.24	1.00		
PR: 0% QL: +1%	L1: 3.26	L1: 3.27	L1: 3.24	1.00	374	1000
	L2: 3.27	L2: 3.29	L2: 3.28	1.00		
	L3: 3.30	L3: 3.39	L3: 3.24	1.01		
PR: 0% QL: +2%	L1: 3.26	L1: 3.30	L1: 3.24	1.00	225	1000
	L2: 3.27	L2: 3.32	L2: 3.28	1.01		
	L3: 3.30	L3: 3.42	L3: 3.24	1.01		
PR: 0% QL: +3%	L1: 3.26	L1: 3.33	L1: 3.24	1.01	148	1000
	L2: 3.27	L2: 3.36	L2: 3.28	1.01		
	L3: 3.30	L3: 3.46	L3: 3.24	1.02		
PR: 0% QL: +4%	L1: 3.26	L1: 3.37	L1: 3.24	1.01	125	1000
	L2: 3.27	L2: 3.39	L2: 3.28	1.02		
	L3: 3.30	L3: 3.49	L3: 3.24	1.02		
PR: 0% QL: +5%	L1: 3.26	L1: 3.40	L1: 3.24	1.02	121	1000
	L2: 3.27	L2: 3.42	L2: 3.24	1.02		
	L3: 3.30	L3: 3.52	L3: 3.28	1.02		

Used equipment No.: See equipment list for details

Sample No.: N/A

Finished date:

Tested by:

Review date:

Reviewed by:





# Compliance Evaluation Report



REPORT No.: CSSC/BOS/012

ISSUED DATE: August 20, 2021

APPENDIX C. TÜV Rheinland's Report No: CN21ZH49 001. (Cont.)

Test Data / Test Plan		TÜVRheinland®	
TÜV Rheinland (Shanghai) Co., Ltd.		Document No.: TD-0189	
Protection and Control requirements for PEA Interface of Inverter based Generation Systems 2016.08		Report No:	CN21ZH49 001
Order No.:	244313300	Product:	Grid-Connected PV Inverter
Client Name:	SolaX Power Network Technology (Zhejiang)Co.,Ltd	Model designation:	X3-Hybrid-15.0

Power 33%						
Conditions	Pr [kW]	Ql [kVar]	Qc [kVar]	Qr	Trip time [ms]	Limitation [ms]
Pr: 0% Ql: -5%	L1: 1.64	L1: 1.49	L1: 1.71	0.97	105	1000
	L2: 1.63	L2: 1.48	L2: 1.72	0.98		
	L3: 1.66	L3: 1.54	L3: 1.70	0.98		
Pr: 0% Ql: -4%	L1: 1.64	L1: 1.50	L1: 1.71	0.98	115	1000
	L2: 1.63	L2: 1.49	L2: 1.72	0.98		
	L3: 1.66	L3: 1.56	L3: 1.70	0.98		
Pr: 0% Ql: -3%	L1: 1.64	L1: 1.52	L1: 1.71	0.98	123	1000
	L2: 1.63	L2: 1.51	L2: 1.72	0.99		
	L3: 1.66	L3: 1.57	L3: 1.70	0.99		
Pr: 0% Ql: -2%	L1: 1.64	L1: 1.53	L1: 1.71	0.99	203	1000
	L2: 1.63	L2: 1.52	L2: 1.72	0.99		
	L3: 1.66	L3: 1.59	L3: 1.70	0.99		
Pr: 0% Ql: -1%	L1: 1.64	L1: 1.55	L1: 1.71	0.99	212	1000
	L2: 1.63	L2: 1.54	L2: 1.72	1.00		
	L3: 1.66	L3: 1.61	L3: 1.70	1.00		
Pr: 0% Ql: 0%	L1: 1.64	L1: 1.57	L1: 1.71	1.00	249	1000
	L2: 1.63	L2: 1.55	L2: 1.72	1.00		
	L3: 1.66	L3: 1.62	L3: 1.70	1.00		
Pr: 0% Ql: +1%	L1: 1.64	L1: 1.58	L1: 1.71	1.00	230	1000
	L2: 1.63	L2: 1.57	L2: 1.72	1.01		
	L3: 1.66	L3: 1.64	L3: 1.70	1.01		
Pr: 0%	L1: 1.64	L1: 1.60	L1: 1.71	1.01	203	

Used equipment No.: See equipment list for details Sample No.: N/A  
 Finished date: \_\_\_\_\_ Tested by: \_\_\_\_\_  
 Review date: \_\_\_\_\_ Reviewed by: \_\_\_\_\_





# Compliance Evaluation Report



REPORT No.: CSSC/BOS/012

ISSUED DATE: August 20, 2021

APPENDIX C. TÜV Rheinland's Report No: CN21ZH49 001. (Cont.)

Test Data / Test Plan					TÜVRheinland®	
TÜV Rheinland (Shanghai) Co., Ltd.			Document No.: TD-0189			
Protection and Control requirements for PEA Interface of Inverter based Generation Systems 2016.08			Report No:		CN21ZH49 001	
Order No. :	244313300		Product:		Grid-Connected PV Inverter	
Client Name :	SolaX Power Network Technology (Zhejiang)Co.,Ltd		Model designation:		X3-Hybrid-15.0	
QL: +2%	L2: 1.63	L2: 1.59	L2: 1.72	1.01		1000
	L3: 1.66	L3: 1.65	L3: 1.70	1.01		
PR: 0%	L1: 1.64	L1: 1.61	L1: 1.71	1.01		
QL: +3%	L2: 1.63	L2: 1.60	L2: 1.72	1.02	195	1000
	L3: 1.66	L3: 1.67	L3: 1.70	1.02		
PR: 0%	L1: 1.64	L1: 1.63	L1: 1.71	1.02		
QL: +4%	L2: 1.63	L2: 1.62	L2: 1.72	1.02	119	1000
	L3: 1.66	L3: 1.69	L3: 1.70	1.02		
PR: 0%	L1: 1.64	L1: 1.64	L1: 1.71	1.02		
QL: +5%	L2: 1.63	L2: 1.63	L2: 1.72	1.03	111	1000
	L3: 1.66	L3: 1.70	L3: 1.70	1.03		
Remark:						

Used equipment No.: See equipment list for details

Sample No.: N/A

Finished date:

Tested by:

Review date:

Reviewed by:





# Compliance Evaluation Report



REPORT No.: CSSC/BOS/012

ISSUED DATE: August 20, 2021

APPENDIX C. TÜV Rheinland's Report No: CN21ZH49 001. (Cont.)

Test Data / Test Plan		TÜVRheinland®	
TÜV Rheinland (Shanghai) Co., Ltd.		Document No.: TD-0189	
Protection and Control requirements for PEA Interface of Inverter based Generation Systems 2016.08		Report No:	CN21ZH49 001
Order No.:	244313300	Product:	Grid-Connected PV Inverter
Client Name:	SolaX Power Network Technology (Zhejiang)Co.,Ltd	Model designation:	X3-Hybrid-15.0

## 8. Response to Utility Recovery

### PROCEDURE

Test methods complies with standard IEEE 1547.1-2005, clause 5.10.

RESULTS  Pass/  Fail

8	TABLE: Response to Utility Recovery		P
	Rated voltage Un: $V_{\phi-n}=220V, V_{\phi-\phi}=380V$	Rated frequency Fn: 50Hz	
Voltage detection accuracy [V]	$\pm 2.2$	Frequency detection accuracy [Hz]	$\pm 0.1$
Specified recover voltage range	$V_{\phi-n}=198-242V$	Specified recover frequency range	47-52Hz
Recover time [s]			120

Conditions <sup>2)</sup>	$U_M$ back to 246.4V	$U_M$ back to 237.6V	$U_M$ back to 193.6V	$U_M$ back to 202.4V
Reconnection	<input type="checkbox"/> Yes/ <input checked="" type="checkbox"/> No	<input checked="" type="checkbox"/> Yes/ <input type="checkbox"/> No	<input type="checkbox"/> Yes/ <input checked="" type="checkbox"/> No	<input checked="" type="checkbox"/> Yes/ <input type="checkbox"/> No
Recover time [s]	N/A	125.1	N/A	121.5
Conditions <sup>3)</sup>	$F_M$ back to 52.2Hz	$F_M$ back to 51.8 Hz	$F_M$ back to 46.8Hz	$F_M$ back to 47.2Hz
Reconnection	<input type="checkbox"/> Yes/ <input checked="" type="checkbox"/> No	<input checked="" type="checkbox"/> Yes/ <input type="checkbox"/> No	<input type="checkbox"/> Yes/ <input checked="" type="checkbox"/> No	<input checked="" type="checkbox"/> Yes/ <input type="checkbox"/> No
Recover time [s]	N/A	123.3	N/A	121.1
Conditions <sup>4)</sup>	$U_M$ back to 237.6V	$U_M$ back to 202.4V	$F_M$ back to 51.8Hz	$F_M$ back to 47.2Hz
Reconnection	<input checked="" type="checkbox"/> Yes/ <input type="checkbox"/> No	<input checked="" type="checkbox"/> Yes/ <input type="checkbox"/> No	<input checked="" type="checkbox"/> Yes/ <input type="checkbox"/> No	<input checked="" type="checkbox"/> Yes/ <input type="checkbox"/> No
Recover time [s]	122.6	123.9	121.1	124.7

### Remark:

1)  $U_M$  =Mains voltage;  $F_M$ =Mains frequency.

2) After mains voltage tripped the over/under voltage limit.

3) After mains voltage frequency tripped the over/under frequency limit.

4) Retest with an abnormal voltage/frequency change event that is introduced during the reconnect countdown period.

Used equipment No.: See equipment list for details

Sample No.: N/A

Finished date:

Tested by:

Review date:

Reviewed by:



# Compliance Evaluation Report



REPORT No.: CSSC/BOS/012

ISSUED DATE: August 20, 2021

APPENDIX C. TÜV Rheinland's Report No: CN21ZH49 001. (Cont.)

Test Data / Test Plan		TÜVRheinland®	
TÜV Rheinland (Shanghai) Co., Ltd.		Document No.: TD-0189	
Protection and Control requirements for PEA Interface of Inverter based Generation Systems 2016.08		Report No:	CN21ZH49 001
Order No.:	244313300	Product:	Grid-Connected PV Inverter
Client Name:	SolaX Power Network Technology (Zhejiang)Co.,Ltd	Model designation:	X3-Hybrid-15.0

## 9. Over/Under voltage

### PROCEDURE

Test methods complies with standard Protection and Control requirements for PEA Interface of Inverter based Generation Systems 2016

RESULTS  Pass /  Fail

9	TABLE: Over/Under voltage				P	
Mains voltage: $V_{\phi-n}=220V, V_{\phi-\phi}=380V$						
Setting value						
Voltage detection accuracy [V]	$\pm 1V$	Voltage detection cycle $T_d$ [ms]		20		
Magnitude $V_{o1}$ [V]	243	delay time $T_{o1}$ [ms]		160		
Magnitude $V_{o2}$ [V]	264	delay time $T_{o2}$ [ms]		160		
Magnitude $V_{u1}$ [V]	197	delay time $T_{u1}$ [ms]		2000		
Magnitude $V_{u2}$ [V]	109	delay time $T_{u2}$ [ms]		240		
Over voltage level 1	Measurement [ms]				Limit [ms]	Remark
	L1	L2	L3	L123		
1	127.0	138.0	131.0	130.5	1000	Mains voltage From: 219.8 V Jump to: 268.6 V
2	127.0	137.5	131.0	131.0	1000	
Over voltage level 2	Measurement [ms]				Limit [ms]	Remark
	L1	L2	L3	L123		
1	106.0	117.0	108.0	110.0	160	Mains voltage From: 238V Jump to: 290V
2	107.0	118.0	108.0	111.0	160	

Used equipment No.: See equipment list for details

Sample No.: N/A

Finished date:

Tested by:

Review date:

Reviewed by:



# Compliance Evaluation Report



REPORT No.: CSSC/BOS/012

ISSUED DATE: August 20, 2021

APPENDIX C. TÜV Rheinland's Report No: CN21ZH49 001. (Cont.)

Test Data / Test Plan					TÜVRheinland®	
TÜV Rheinland (Shanghai) Co., Ltd.				Document No.: TD-0189		
Protection and Control requirements for PEA Interface of Inverter based Generation Systems 2016.08				Report No:		CN21ZH49 001
Order No.:		244313300		Product:		Grid-Connected PV Inverter
Client Name:		SolaX Power Network Technology (Zhejiang)Co.,Ltd		Model designation:		X3-Hybrid-15.0

Under voltage level 1	Measurement [ms]				Limit [ms]	Remark
	L1	L2	L3	L123		
1	1940.0	1931.0	1941.0	1923.1	2000	Mains voltage
2	1942.0	1929.8	1941.3	1925.7	2000	From: 215.4V Jump to: 176.2V

Under voltage level 2	Measurement [ms]				Limit [ms]	Remark
	L1	L2	L3	L123		
1	243.0	231.0	243.0	226.0	300	Mains voltage
2	224.0	231.5	239.0	227.0	300	From: 118.6V Jump to: 97.0V

Remark:  
Vo1= First level over voltage magnitude, Vo2= Second level over voltage magnitude,  
Vu1= First level under voltage magnitude, Vu2= Second level under voltage magnitude  
To1= Delayed time for first level over voltage tripping, To2= Delayed time for second level over voltage tripping  
Tu1= Delayed time for first level under voltage tripping, Tu2= Delayed time for second level under voltage tripping

Used equipment No.: See equipment list for details      Sample No.: N/A  
Finished date: \_\_\_\_\_      Tested by: \_\_\_\_\_  
Review date: \_\_\_\_\_      Reviewed by: \_\_\_\_\_





# Compliance Evaluation Report



REPORT No.: CSSC/BOS/012

ISSUED DATE: August 20, 2021

APPENDIX C. TÜV Rheinland's Report No: CN21ZH49 001. (Cont.)

Test Data / Test Plan		TÜVRheinland®	
TÜV Rheinland (Shanghai) Co., Ltd.		Document No.: TD-0189	
Protection and Control requirements for PEA Interface of Inverter based Generation Systems 2016.08		Report No:	CN21ZH49 001
Order No.:	244313300	Product:	Grid-Connected PV Inverter
Client Name:	SolaX Power Network Technology (Zhejiang)Co.,Ltd	Model designation:	X3-Hybrid-15.0

## 10. Harmonic and waveform distortion

### PROCEDURE

Test methods complies with standard IEC 61000-3-12.

Limit see following table:

Table 2. Current distortion limits

Odd Harmonic	THD, in each harmonic order (%)
3 - 9	4.0
11 - 15	2.0
17 - 21	1.5
23 - 33	0.9
Even Harmonic	THD, in each harmonic order (%)
2 - 8	2.0
10 - 32	0.5

RESULTS  Pass /  Fail

10	TABLE: Harmonic and waveform distortion						P
	Mains voltage: $V_{\phi-n}=220V, V_{\phi-\phi}=380V$						
	P/Pn[%]	100%		66%		33%	
Ordinal number	Measurement						
	[A]	[%]	[A]	[%]	[A]	[%]	[%]
1	21.30	--	14.05	-	6.90	--	--
2	0.18	0.85	0.12	0.85	0.06	0.87	1.0
3	0.06	0.28	0.05	0.36	0.02	0.29	4.0
4	0.01	0.05	0.01	0.07	0.02	0.29	1.0
5	0.61	2.86	0.34	2.42	0.17	2.46	4.0

Used equipment No.: See equipment list for details

Sample No.: N/A

Finished date:

Tested by:

Review date:

Reviewed by:





# Compliance Evaluation Report



REPORT No.: CSSC/BOS/012

ISSUED DATE: August 20, 2021

APPENDIX C. TÜV Rheinland's Report No: CN21ZH49 001. (Cont.)

<b>Test Data / Test Plan</b>			
TÜV Rheinland (Shanghai) Co., Ltd.		Document No.: TD-0189	
Protection and Control requirements for PEA Interface of Inverter based Generation Systems 2016.08		Report No:	CN21ZH49 001
Order No.:	244313300	Product:	Grid-Connected PV Inverter
Client Name:	SolaX Power Network Technology (Zhejiang)Co.,Ltd	Model designation:	X3-Hybrid-15.0

6	0.02	0.09	0.01	0.07	0.00	0.00	1.0
7	0.38	1.78	0.20	1.42	0.09	1.30	4.0
8	0.01	0.05	0.01	0.07	0.01	0.14	1.0
9	0.04	0.19	0.03	0.21	0.01	0.14	4.0
10	0.01	0.05	0.00	0.00	0.00	0.00	0.5
11	0.19	0.89	0.11	0.78	0.02	0.29	2.0
12	0.01	0.05	0.00	0.00	0.01	0.14	0.5
13	0.09	0.42	0.06	0.43	0.01	0.14	2.0
14	0.00	0.00	0.00	0.00	0.00	0.00	0.5
15	0.01	0.05	0.01	0.07	0.01	0.14	2.0
16	0.00	0.00	0.00	0.00	0.00	0.00	0.5
17	0.04	0.19	0.02	0.14	0.02	0.29	1.5
18	0.00	0.00	0.00	0.00	0.00	0.00	0.5
19	0.04	0.19	0.03	0.21	0.02	0.29	1.5
20	0.01	0.05	0.00	0.00	0.00	0.00	0.5
21	0.00	0.00	0.01	0.07	0.00	0.00	1.5
22	0.00	0.00	0.00	0.00	0.00	0.00	0.5
23	0.02	0.09	0.02	0.14	0.01	0.14	0.6
24	0.00	0.00	0.00	0.00	0.00	0.00	0.5
25	0.03	0.14	0.02	0.14	0.01	0.14	0.6
26	0.00	0.00	0.00	0.00	0.00	0.00	0.5
27	0.01	0.05	0.01	0.07	0.00	0.00	0.6
28	0.00	0.00	0.00	0.00	0.00	0.00	0.5
29	0.02	0.09	0.01	0.07	0.00	0.00	0.6

Used equipment No.: See equipment list for details Sample No.: N/A  
 Finished date: \_\_\_\_\_ Tested by: \_\_\_\_\_  
 Review date: \_\_\_\_\_ Reviewed by: \_\_\_\_\_





# Compliance Evaluation Report



REPORT No.: CSSC/BOS/012

ISSUED DATE: August 20, 2021

APPENDIX C. TÜV Rheinland's Report No: CN21ZH49 001. (Cont.)

Test Data / Test Plan		TÜVRheinland®	
TÜV Rheinland (Shanghai) Co., Ltd.		Document No.: TD-0189	
Protection and Control requirements for PEA Interface of Inverter based Generation Systems 2016.08		Report No:	CN21ZH49 001
Order No.:	244313300	Product:	Grid-Connected PV Inverter
Client Name:	SolaX Power Network Technology (Zhejiang)Co.,Ltd	Model designation:	X3-Hybrid-15.0

30	0.00	0.00	0.00	0.00	0.00	0.00	0.5
31	0.02	0.09	0.01	0.07	0.00	0.00	0.6
32	0.00	0.00	0.00	0.00	0.00	0.00	0.5
33	0.01	0.05	0.01	0.07	0.00	0.00	0.6
THD	3.65		3.12		3.48		5

Remark: The worst case of three phases was selected.

Ordinal number	100%		66%		33%		Limit
	Measurement						
	[V]	[%]	[V]	[%]	[V]	[%]	
1	220.62	-	220.46	-	220.33	-	-
2	0.06	0.03	0.08	0.04	0.05	0.02	2
3	0.43	0.20	0.12	0.06	0.10	0.05	4
4	0.02	0.01	0.04	0.02	0.01	0.00	2
5	0.62	0.28	0.42	0.19	0.19	0.09	4
6	0.01	0.01	0.03	0.01	0.00	0.00	2
7	0.56	0.25	0.31	0.14	0.15	0.07	4
8	0.02	0.01	0.02	0.01	0.00	0.00	2
9	0.08	0.04	0.03	0.01	0.02	0.01	4
10	0.01	0.00	0.01	0.01	0.01	0.00	2
11	0.24	0.11	0.16	0.07	0.06	0.03	4
12	0.01	0.00	0.01	0.00	0.00	0.00	2
13	0.17	0.08	0.13	0.06	0.03	0.02	4
14	0.01	0.00	0.01	0.00	0.01	0.00	2
15	0.05	0.02	0.03	0.01	0.01	0.00	4
16	0.01	0.00	0.01	0.00	0.01	0.00	2

Used equipment No.: See equipment list for details

Sample No.: N/A

Finished date:

Tested by:

Review date:

Reviewed by:





# Compliance Evaluation Report



REPORT No.: CSSC/BOS/012

ISSUED DATE: August 20, 2021

APPENDIX C. TÜV Rheinland's Report No: CN21ZH49 001. (Cont.)

Test Data / Test Plan							TÜVRheinland®
TÜV Rheinland (Shanghai) Co., Ltd.				Document No.: TD-0189			
Protection and Control requirements for PEA Interface of Inverter based Generation Systems 2016.08				Report No:		CN21ZH49 001	
Order No.:		244313300		Product:		Grid-Connected PV Inverter	
Client Name:		SolaX Power Network Technology (Zhejiang)Co.,Ltd		Model designation:		X3-Hybrid-15.0	
17	0.11	0.05	0.07	0.03	0.01	0.00	4
18	0.00	0.00	0.01	0.00	0.00	0.00	2
19	0.07	0.03	0.05	0.02	0.01	0.00	4
20	0.01	0.00	0.01	0.00	0.00	0.00	2
21	0.02	0.01	0.01	0.01	0.00	0.00	4
22	0.01	0.00	0.01	0.00	0.00	0.00	2
23	0.03	0.02	0.03	0.02	0.01	0.01	4
24	0.00	0.00	0.01	0.00	0.00	0.00	2
25	0.04	0.02	0.04	0.02	0.02	0.01	4
26	0.00	0.00	0.01	0.00	0.00	0.00	2
27	0.02	0.01	0.01	0.00	0.01	0.00	4
28	0.00	0.00	0.01	0.00	0.00	0.00	2
29	0.04	0.02	0.02	0.01	0.01	0.01	4
30	0.00	0.00	0.01	0.00	0.00	0.00	2
31	0.04	0.02	0.02	0.01	0.01	0.00	4
32	0.01	0.00	0.01	0.00	0.00	0.00	2
33	0.00	0.00	0.01	0.00	0.01	0.00	4
THD	0.46		0.27		0.13		5

Remark: The worst case of three phases were determined.

Used equipment No.: See equipment list for details

Sample No.: N/A

Finished date:

Tested by:

Review date:

Reviewed by:





# Compliance Evaluation Report



REPORT No.: CSSC/BOS/012

ISSUED DATE: August 20, 2021

APPENDIX C. TÜV Rheinland's Report No: CN21ZH49 001. (Cont.)

Test Data / Test Plan		TÜVRheinland®	
TÜV Rheinland (Shanghai) Co., Ltd.		Document No.: TD-0189	
Protection and Control requirements for PEA Interface of Inverter based Generation Systems 2016.08		Report No:	CN21ZH49 001
Order No.:	244313300	Product:	Grid-Connected PV Inverter
Client Name:	SolaX Power Network Technology (Zhejiang)Co.,Ltd	Model designation:	X3-Hybrid-15.0

## 11. Over/Under Frequency

### PROCEDURE

Test method complies with standard Protection and Control requirements for PEA Interface of Inverter based Generation Systems 2016.

RESULTS  Pass /  Fail

11	TABLE: Over/Under frequency			P
Rated voltage frequency: 50Hz				
Setting value				
Frequency detection accuracy [Hz]	±0.1	Frequency detection cycle Td [ms]	20	
Magnitude Fo [Hz]	52.1	Fo delay time To [ms]	100	
Magnitude Fu [Hz]	46.9	Fu delay time Tu [ms]	100	
Over frequency	Measurement [ms]	Limit [ms]	Remark	
1	62.0	100	Mains voltage frequency From: 51.6Hz Jump to: 52.6Hz	
Under frequency	Measurement [ms]	Limit [ms]	Remark	
1	62.0	100	Mains voltage frequency From: 47.4Hz Jump to: 46.4Hz	
Remark: Fo= Over frequency magnitude, Fu= Under frequency magnitude, To= Delayed time for over frequency tripping Tu= Delayed time for under frequency tripping				

Used equipment No.: See equipment list for details      Sample No.: N/A

Finished date: \_\_\_\_\_      Tested by: \_\_\_\_\_

Review date: \_\_\_\_\_      Reviewed by: \_\_\_\_\_





# Compliance Evaluation Report



REPORT No.: CSSC/BOS/012

ISSUED DATE: August 20, 2021

APPENDIX C. TÜV Rheinland's Report No: CN21ZH49 001. (Cont.)

Test Data / Test Plan		TÜVRheinland®	
TÜV Rheinland (Shanghai) Co., Ltd.		Document No.: TD-0189	
Protection and Control requirements for PEA Interface of Inverter based Generation Systems 2016.08		Report No:	CN21ZH49 001
Order No.:	244313300	Product:	Grid-Connected PV Inverter
Client Name:	SolaX Power Network Technology (Zhejiang)Co.,Ltd	Model designation:	X3-Hybrid-15.0

## 12. Active power control

### PROCEDURE

The test methods complies with standard Protection and Control requirements for PEA Interface of Inverter based Generation Systems 2016

RESULTS  Pass /  Fail

12	TABLE: Active power control											P	
Rating power P (kW)	14												
Set Point	100%	90%	80%	70%	60%	50%	40%	30%	20%	10%	0%		
Output Power P (kW)	14.0	12.7	11.2	9.8	8.4	7.0	6.0	4.2	2.8	1.4	0.0		
Adjusting time (s)	Limitation of $\Delta P$			$\pm 5\% P_n$									
	-	18.15	19.15	22.55	18.52	20.21	19.54	20.22	19.75	21.15	19.46		
Total Duration (s)	Limitation of $\Delta I$			60									
	570.15												
Remark: $\Delta P$ - power deviation, $\Delta I$ - response duration													

Used equipment No.: See equipment list for details

Sample No.: N/A

Finished date:

Tested by:

Review date:

Reviewed by:



# Compliance Evaluation Report



REPORT No.: CSSC/BOS/012

ISSUED DATE: August 20, 2021

APPENDIX C. TÜV Rheinland's Report No: CN21ZH49 001. (Cont.)

<b>Test Data / Test Plan</b>			
TÜV Rheinland (Shanghai) Co., Ltd.		Document No.: TD-0189	
Protection and Control requirements for PEA Interface of Inverter based Generation Systems 2016.08		Report No:	CN21ZH49 001
Order No. :	244313300	Product:	Grid-Connected PV Inverter
Client Name :	SolaX Power Network Technology (Zhejiang)Co.,Ltd	Model designation:	X3-Hybrid G4

## Attachment : 1

Picture No.:	1	Clause:	7
Test:	<input checked="" type="checkbox"/> Islanding Protection <input type="checkbox"/> Secondary Over Voltage Magnitude <input type="checkbox"/> Secondary Over Voltage Trip Time <input type="checkbox"/> Secondary Under Voltage Magnitude <input type="checkbox"/> Secondary Under Voltage Trip Time <input type="checkbox"/> Under Frequency Magnitude <input type="checkbox"/> Under Frequency Trip Time <input type="checkbox"/> First Over Voltage Magnitude <input type="checkbox"/> First Over Voltage Trip Time <input type="checkbox"/> First Under Voltage Magnitude <input type="checkbox"/> First Under Voltage Trip Time <input type="checkbox"/> Over Frequency Magnitude <input type="checkbox"/> Over Frequency Trip Time <input type="checkbox"/> Response to Utility Recovery		
Test description:	100% load, PR: -10%, QL: +10%, the trip time of protection was 84.00ms. CH1/2/7 were the output currents of the inverter; CH3/9/10 were the currents flowing through to the grid, also regarded as the trip signal while the grid was switched off. The wave No. was ordered from top to end.		



Used equipment No.: See equipment list for details      Sample No.: N/A

Finished date: \_\_\_\_\_      Tested by: \_\_\_\_\_

Review date: \_\_\_\_\_      Reviewed by: \_\_\_\_\_



# Compliance Evaluation Report



REPORT No.: CSSC/BOS/012

ISSUED DATE: August 20, 2021

APPENDIX C. TÜV Rheinland's Report No: CN21ZH49 001. (Cont.)

<b>Test Data / Test Plan</b>			
TÜV Rheinland (Shanghai) Co., Ltd.		Document No.: TD-0189	
Protection and Control requirements for PEA Interface of Inverter based Generation Systems 2016.08		Report No:	CN21ZH49 001
Order No. :	244313300	Product:	Grid-Connected PV Inverter
Client Name :	SolaX Power Network Technology (Zhejiang)Co.,Ltd	Model designation:	X3-Hybrid G4

## Attachment : 1

Picture No.:	2	Clause:	7
Test:	<input checked="" type="checkbox"/> Islanding Protection <input type="checkbox"/> Secondary Over Voltage Magnitude <input type="checkbox"/> Secondary Over Voltage Trip Time <input type="checkbox"/> Secondary Under Voltage Magnitude <input type="checkbox"/> Secondary Under Voltage Trip Time <input type="checkbox"/> Under Frequency Magnitude <input type="checkbox"/> Under Frequency Trip Time	<input type="checkbox"/> First Over Voltage Magnitude <input type="checkbox"/> First Over Voltage Trip Time <input type="checkbox"/> First Under Voltage Magnitude <input type="checkbox"/> First Under Voltage Trip Time <input type="checkbox"/> Over Frequency Magnitude <input type="checkbox"/> Over Frequency Trip Time <input type="checkbox"/> Response to Utility Recovery	
Test description:	100% load, PR: -10%, OL: +5%, the trip time of protection was 86.00ms. CH1/2/7 were the output currents of the inverter; CH8/9/10 were the currents flowing through to the grid, also regarded as the trip signal while the grid was switched off. The wave No. was ordered from top to end.		



Used equipment No.: See equipment list for details      Sample No.: N/A

Finished date: \_\_\_\_\_      Tested by: \_\_\_\_\_

Review date: \_\_\_\_\_      Reviewed by: \_\_\_\_\_





# Compliance Evaluation Report



REPORT No.: CSSC/BOS/012

ISSUED DATE: August 20, 2021

APPENDIX C. TÜV Rheinland's Report No: CN21ZH49 001. (Cont.)

<b>Test Data / Test Plan</b>			
TÜV Rheinland (Shanghai) Co., Ltd.		Document No.: TD-0189	
Protection and Control requirements for PEA Interface of Inverter based Generation Systems 2016.08		Report No:	CN21ZH49 001
Order No. :	244313300	Product:	Grid-Connected PV Inverter
Client Name :	SolaX Power Network Technology (Zhejiang)Co.,Ltd	Model designation:	X3-Hybrid G4

## Attachment : 1

Picture No.:	3	Clause:	7
Test:	<input checked="" type="checkbox"/> Islanding Protection <input type="checkbox"/> Secondary Over Voltage Magnitude <input type="checkbox"/> Secondary Over Voltage Trip Time <input type="checkbox"/> Secondary Under Voltage Magnitude <input type="checkbox"/> Secondary Under Voltage Trip Time <input type="checkbox"/> Under Frequency Magnitude <input type="checkbox"/> Under Frequency Trip Time	<input type="checkbox"/> First Over Voltage Magnitude <input type="checkbox"/> First Over Voltage Trip Time <input type="checkbox"/> First Under Voltage Magnitude <input type="checkbox"/> First Under Voltage Trip Time <input type="checkbox"/> Over Frequency Magnitude <input type="checkbox"/> Over Frequency Trip Time <input type="checkbox"/> Response to Utility Recovery	
Test description:	100% load, PR: -10%, QL: 0%, the trip time of protection was 97.00ms. CH1/2/7 were the output currents of the inverter; CH8/9/10 were the currents flowing through to the grid, also regarded as the trip signal while the grid was switched off. The wave No. was ordered from top to end.		

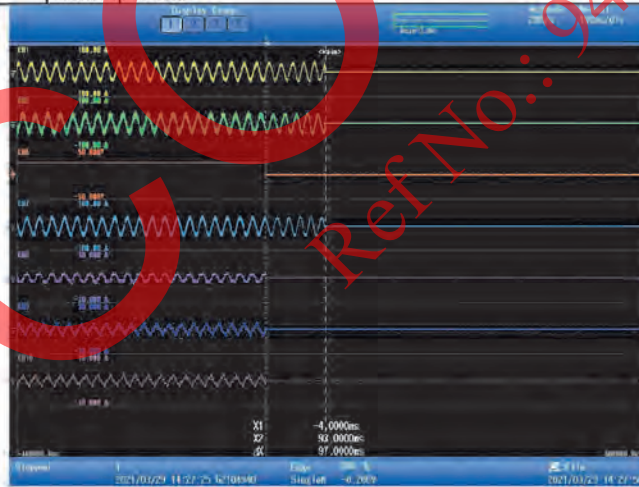

Used equipment No.: See equipment list for details      Sample No.: N/A

Finished date: \_\_\_\_\_      Tested by: \_\_\_\_\_

Review date: \_\_\_\_\_      Reviewed by: \_\_\_\_\_





# Compliance Evaluation Report



REPORT No.: CSSC/BOS/012

ISSUED DATE: August 20, 2021

APPENDIX C. TÜV Rheinland's Report No: CN21ZH49 001. (Cont.)

<b>Test Data / Test Plan</b>			
TÜV Rheinland (Shanghai) Co., Ltd.		Document No.: TD-0189	
Protection and Control requirements for PEA Interface of Inverter based Generation Systems 2016.08		Report No:	CN21ZH49 001
Order No. :	244313300	Product:	Grid-Connected PV Inverter
Client Name :	SolaX Power Network Technology (Zhejiang)Co.,Ltd	Model designation:	X3-Hybrid G4

## Attachment : 1

Picture No.:	4	Clause:	7
Test:	<input checked="" type="checkbox"/> Islanding Protection <input type="checkbox"/> Secondary Over Voltage Magnitude <input type="checkbox"/> Secondary Over Voltage Trip Time <input type="checkbox"/> Secondary Under Voltage Magnitude <input type="checkbox"/> Secondary Under Voltage Trip Time <input type="checkbox"/> Under Frequency Magnitude <input type="checkbox"/> Under Frequency Trip Time	<input type="checkbox"/> First Over Voltage Magnitude <input type="checkbox"/> First Over Voltage Trip Time <input type="checkbox"/> First Under Voltage Magnitude <input type="checkbox"/> First Under Voltage Trip Time <input type="checkbox"/> Over Frequency Magnitude <input type="checkbox"/> Over Frequency Trip Time <input type="checkbox"/> Response to Utility Recovery	
Test description:	100% load, PR: -10%, QL: -5%, the trip time of protection was 101.00ms. CH1/2/7 were the output currents of the inverter; CH8/9/10 were the currents flowing through to the grid, also regarded as the trip signal while the grid was switched off. The wave No. was ordered from top to end.		



Used equipment No.: See equipment list for details      Sample No.: N/A

Finished date: \_\_\_\_\_      Tested by: \_\_\_\_\_

Review date: \_\_\_\_\_      Reviewed by: \_\_\_\_\_





# Compliance Evaluation Report



REPORT No.: CSSC/BOS/012

ISSUED DATE: August 20, 2021

APPENDIX C. TÜV Rheinland's Report No: CN21ZH49 001. (Cont.)

<b>Test Data / Test Plan</b>			
TÜV Rheinland (Shanghai) Co., Ltd.		Document No.: TD-0189	
Protection and Control requirements for PEA Interface of Inverter based Generation Systems 2016.08		Report No:	CN21ZH49 001
Order No. :	244313300	Product:	Grid-Connected PV Inverter
Client Name :	SolaX Power Network Technology (Zhejiang)Co.,Ltd	Model designation:	X3-Hybrid G4

## Attachment : 1

Picture No.:	5	Clause:	7
Test:	<input checked="" type="checkbox"/> Islanding Protection <input type="checkbox"/> Secondary Over Voltage Magnitude <input type="checkbox"/> Secondary Over Voltage Trip Time <input type="checkbox"/> Secondary Under Voltage Magnitude <input type="checkbox"/> Secondary Under Voltage Trip Time <input type="checkbox"/> Under Frequency Magnitude <input type="checkbox"/> Under Frequency Trip Time	<input type="checkbox"/> First Over Voltage Magnitude <input type="checkbox"/> First Over Voltage Trip Time <input type="checkbox"/> First Under Voltage Magnitude <input type="checkbox"/> First Under Voltage Trip Time <input type="checkbox"/> Over Frequency Magnitude <input type="checkbox"/> Over Frequency Trip Time <input type="checkbox"/> Response to Utility Recovery	
Test description:	100% load, PR: -10%, QL: -10%, the trip time of protection was 103ms. CH1/2/7 were the output currents of the inverter; CH8/9/10 were the currents flowing through to the grid, also regarded as the trip signal while the grid was switched off. The wave No. was ordered from top to end.		



Used equipment No.: See equipment list for details      Sample No.: N/A

Finished date: \_\_\_\_\_      Tested by: \_\_\_\_\_

Review date: \_\_\_\_\_      Reviewed by: \_\_\_\_\_





# Compliance Evaluation Report



REPORT No.: CSSC/BOS/012

ISSUED DATE: August 20, 2021

APPENDIX C. TÜV Rheinland's Report No: CN21ZH49 001. (Cont.)

<b>Test Data / Test Plan</b>			
TÜV Rheinland (Shanghai) Co., Ltd.		Document No.: TD-0189	
Protection and Control requirements for PEA Interface of Inverter based Generation Systems 2016.08		Report No:	CN21ZH49 001
Order No. :	244313300	Product:	Grid-Connected PV Inverter
Client Name :	SolaX Power Network Technology (Zhejiang)Co.,Ltd	Model designation:	X3-Hybrid G4

## Attachment : 1

Picture No.:	6	Clause:	7
Test:	<input checked="" type="checkbox"/> Islanding Protection <input type="checkbox"/> Secondary Over Voltage Magnitude <input type="checkbox"/> Secondary Over Voltage Trip Time <input type="checkbox"/> Secondary Under Voltage Magnitude <input type="checkbox"/> Secondary Under Voltage Trip Time <input type="checkbox"/> Under Frequency Magnitude <input type="checkbox"/> Under Frequency Trip Time		<input type="checkbox"/> First Over Voltage Magnitude <input type="checkbox"/> First Over Voltage Trip Time <input type="checkbox"/> First Under Voltage Magnitude <input type="checkbox"/> First Under Voltage Trip Time <input type="checkbox"/> Over Frequency Magnitude <input type="checkbox"/> Over Frequency Trip Time <input type="checkbox"/> Response to Utility Recovery
Test description:	100% load, PR: -5%, QL: +10%, the trip time of protection was 108.00ms. CH1/2/7 were the output currents of the inverter; CH8/9/10 were the currents flowing through to the grid, also regarded as the trip signal while the grid was switched off. The wave No. was ordered from top to end.		



Used equipment No.: See equipment list for details      Sample No.: N/A  
 Finished date: \_\_\_\_\_      Tested by: \_\_\_\_\_  
 Review date: \_\_\_\_\_      Reviewed by: \_\_\_\_\_





# Compliance Evaluation Report



REPORT No.: CSSC/BOS/012

ISSUED DATE: August 20, 2021

APPENDIX C. TÜV Rheinland's Report No: CN21ZH49 001. (Cont.)

<b>Test Data / Test Plan</b>			
TÜV Rheinland (Shanghai) Co., Ltd.		Document No.: TD-0189	
Protection and Control requirements for PEA Interface of Inverter based Generation Systems 2016.08		Report No:	CN21ZH49 001
Order No. :	244313300	Product:	Grid-Connected PV Inverter
Client Name :	SolaX Power Network Technology (Zhejiang)Co.,Ltd	Model designation:	X3-Hybrid G4

## Attachment : 1

Picture No.:	7	Clause:	7
Test:	<input checked="" type="checkbox"/> Islanding Protection <input type="checkbox"/> Secondary Over Voltage Magnitude <input type="checkbox"/> Secondary Over Voltage Trip Time <input type="checkbox"/> Secondary Under Voltage Magnitude <input type="checkbox"/> Secondary Under Voltage Trip Time <input type="checkbox"/> Under Frequency Magnitude <input type="checkbox"/> Under Frequency Trip Time		<input type="checkbox"/> First Over Voltage Magnitude <input type="checkbox"/> First Over Voltage Trip Time <input type="checkbox"/> First Under Voltage Magnitude <input type="checkbox"/> First Under Voltage Trip Time <input type="checkbox"/> Over Frequency Magnitude <input type="checkbox"/> Over Frequency Trip Time <input type="checkbox"/> Response to Utility Recovery
Test description:	100% load, PR: -5%, QL: -10%, the trip time of protection was 109.00ms. CH1/2/7 were the output currents of the inverter, CH8/9/10 were the currents flowing through to the grid, also regarded as the trip signal while the grid was switched off. The wave No. was ordered from top to end.		



Used equipment No.: See equipment list for details      Sample No.: N/A

Finished date: \_\_\_\_\_      Tested by: \_\_\_\_\_

Review date: \_\_\_\_\_      Reviewed by: \_\_\_\_\_



# Compliance Evaluation Report



REPORT No.: CSSC/BOS/012

ISSUED DATE: August 20, 2021

APPENDIX C. TÜV Rheinland's Report No: CN21ZH49 001. (Cont.)

<b>Test Data / Test Plan</b>			
TÜV Rheinland (Shanghai) Co., Ltd.		Document No.: TD-0189	
Protection and Control requirements for PEA Interface of Inverter based Generation Systems 2016.08		Report No:	CN21ZH49 001
Order No. :	244313300	Product:	Grid-Connected PV Inverter
Client Name :	SolaX Power Network Technology (Zhejiang)Co.,Ltd	Model designation:	X3-Hybrid G4

## Attachment : 1

Picture No.:	8	Clause:	7
Test:	<input checked="" type="checkbox"/> Islanding Protection <input type="checkbox"/> Secondary Over Voltage Magnitude <input type="checkbox"/> Secondary Over Voltage Trip Time <input type="checkbox"/> Secondary Under Voltage Magnitude <input type="checkbox"/> Secondary Under Voltage Trip Time <input type="checkbox"/> Under Frequency Magnitude <input type="checkbox"/> Under Frequency Trip Time		<input type="checkbox"/> First Over Voltage Magnitude <input type="checkbox"/> First Over Voltage Trip Time <input type="checkbox"/> First Under Voltage Magnitude <input type="checkbox"/> First Under Voltage Trip Time <input type="checkbox"/> Over Frequency Magnitude <input type="checkbox"/> Over Frequency Trip Time <input type="checkbox"/> Response to Utility Recovery
Test description:	100% load, PR: 0%, QL: +10%, the trip time of protection was 110.00ms. CH1/2/7 were the output currents of the inverter; CH8/9/10 were the currents flowing through to the grid, also regarded as the trip signal while the grid was switched off. The wave No. was ordered from top to end.		



Used equipment No.: See equipment list for details      Sample No.: N/A  
 Finished date: \_\_\_\_\_      Tested by: \_\_\_\_\_  
 Review date: \_\_\_\_\_      Reviewed by: \_\_\_\_\_



# Compliance Evaluation Report



REPORT No.: CSSC/BOS/012

ISSUED DATE: August 20, 2021

APPENDIX C. TÜV Rheinland's Report No: CN21ZH49 001. (Cont.)

<b>Test Data / Test Plan</b>			
TÜV Rheinland (Shanghai) Co., Ltd.		Document No.: TD-0189	
Protection and Control requirements for PEA Interface of Inverter based Generation Systems 2016.08		Report No:	CN21ZH49 001
Order No. :	244313300	Product:	Grid-Connected PV Inverter
Client Name :	SolaX Power Network Technology (Zhejiang)Co.,Ltd	Model designation:	X3-Hybrid G4

## Attachment : 1

Picture No.:	9	Clause:	7
Test:	<input checked="" type="checkbox"/> Islanding Protection <input type="checkbox"/> Secondary Over Voltage Magnitude <input type="checkbox"/> Secondary Over Voltage Trip Time <input type="checkbox"/> Secondary Under Voltage Magnitude <input type="checkbox"/> Secondary Under Voltage Trip Time <input type="checkbox"/> Under Frequency Magnitude <input type="checkbox"/> Under Frequency Trip Time	<input type="checkbox"/> First Over Voltage Magnitude <input type="checkbox"/> First Over Voltage Trip Time <input type="checkbox"/> First Under Voltage Magnitude <input type="checkbox"/> First Under Voltage Trip Time <input type="checkbox"/> Over Frequency Magnitude <input type="checkbox"/> Over Frequency Trip Time <input type="checkbox"/> Response to Utility Recovery	
Test description:	100% load, PR: -5%, QL: +5%, the trip time of protection was 116.00ms. CH1/2/7 were the output currents of the inverter; CH8/9/10 were the currents flowing through to the grid, also regarded as the trip signal while the grid was switched off. The wave No. was ordered from top to end.		



Used equipment No.: See equipment list for details      Sample No.: N/A

Finished date: \_\_\_\_\_      Tested by: \_\_\_\_\_

Review date: \_\_\_\_\_      Reviewed by: \_\_\_\_\_



# Compliance Evaluation Report



REPORT No.: CSSC/BOS/012

ISSUED DATE: August 20, 2021

APPENDIX C. TÜV Rheinland's Report No: CN21ZH49 001. (Cont.)

<b>Test Data / Test Plan</b>			
TÜV Rheinland (Shanghai) Co., Ltd.		Document No.: TD-0189	
Protection and Control requirements for PEA Interface of Inverter based Generation Systems 2016.08		Report No:	CN21ZH49 001
Order No. :	244313300	Product:	Grid-Connected PV Inverter
Client Name :	SolaX Power Network Technology (Zhejiang)Co.,Ltd	Model designation:	X3-Hybrid G4

## Attachment : 1

Picture No.:	10	Clause:	7
Test:	<input checked="" type="checkbox"/> Islanding Protection <input type="checkbox"/> Secondary Over Voltage Magnitude <input type="checkbox"/> Secondary Over Voltage Trip Time <input type="checkbox"/> Secondary Under Voltage Magnitude <input type="checkbox"/> Secondary Under Voltage Trip Time <input type="checkbox"/> Under Frequency Magnitude <input type="checkbox"/> Under Frequency Trip Time		<input type="checkbox"/> First Over Voltage Magnitude <input type="checkbox"/> First Over Voltage Trip Time <input type="checkbox"/> First Under Voltage Magnitude <input type="checkbox"/> First Under Voltage Trip Time <input type="checkbox"/> Over Frequency Magnitude <input type="checkbox"/> Over Frequency Trip Time <input type="checkbox"/> Response to Utility Recovery
Test description:	100% load, PR: -5%, QL: 0%, the trip time of protection was 139.00ms. CH1/2/7 were the output currents of the inverter; CH8/9/10 were the currents flowing through to the grid, also regarded as the trip signal while the grid was switched off. The wave No. was ordered from top to end.		



Used equipment No.: See equipment list for details      Sample No.: N/A

Finished date: \_\_\_\_\_      Tested by: \_\_\_\_\_

Review date: \_\_\_\_\_      Reviewed by: \_\_\_\_\_





# Compliance Evaluation Report



REPORT No.: CSSC/BOS/012

ISSUED DATE: August 20, 2021

APPENDIX C. TÜV Rheinland's Report No: CN21ZH49 001. (Cont.)

<b>Test Data / Test Plan</b>			
TÜV Rheinland (Shanghai) Co., Ltd.		Document No.: TD-0189	
Protection and Control requirements for PEA Interface of Inverter based Generation Systems 2016.08		Report No:	CN21ZH49 001
Order No. :	244313300	Product:	Grid-Connected PV Inverter
Client Name :	SolaX Power Network Technology (Zhejiang)Co.,Ltd	Model designation:	X3-Hybrid G4

## Attachment : 1

Picture No.:	11	Clause:	7
Test:	<input checked="" type="checkbox"/> Islanding Protection <input type="checkbox"/> Secondary Over Voltage Magnitude <input type="checkbox"/> Secondary Over Voltage Trip Time <input type="checkbox"/> Secondary Under Voltage Magnitude <input type="checkbox"/> Secondary Under Voltage Trip Time <input type="checkbox"/> Under Frequency Magnitude <input type="checkbox"/> Under Frequency Trip Time	<input type="checkbox"/> First Over Voltage Magnitude <input type="checkbox"/> First Over Voltage Trip Time <input type="checkbox"/> First Under Voltage Magnitude <input type="checkbox"/> First Under Voltage Trip Time <input type="checkbox"/> Over Frequency Magnitude <input type="checkbox"/> Over Frequency Trip Time <input type="checkbox"/> Response to Utility Recovery	
Test description:	100% load, PR: -5%, QL: -5%, the trip time of protection was 247.00ms. CH1/2/7 were the output currents of the inverter; CH8/9/10 were the currents flowing through to the grid, also regarded as the trip signal while the grid was switched off. The wave No. was ordered from top to end.		



Used equipment No.:	See equipment list for details	Sample No.:	N/A
Finished date:	_____	Tested by:	_____
Review date:	_____	Reviewed by:	_____





# Compliance Evaluation Report



REPORT No.: CSSC/BOS/012

ISSUED DATE: August 20, 2021

APPENDIX C. TÜV Rheinland's Report No: CN21ZH49 001. (Cont.)

<b>Test Data / Test Plan</b>			
TÜV Rheinland (Shanghai) Co., Ltd.		Document No.: TD-0189	
Protection and Control requirements for PEA Interface of Inverter based Generation Systems 2016.08		Report No:	CN21ZH49 001
Order No. :	244313300	Product:	Grid-Connected PV Inverter
Client Name :	SolaX Power Network Technology (Zhejiang)Co.,Ltd	Model designation:	X3-Hybrid G4

## Attachment : 1

Picture No.:	12	Clause:	7
Test:	<input checked="" type="checkbox"/> Islanding Protection <input type="checkbox"/> Secondary Over Voltage Magnitude <input type="checkbox"/> Secondary Over Voltage Trip Time <input type="checkbox"/> Secondary Under Voltage Magnitude <input type="checkbox"/> Secondary Under Voltage Trip Time <input type="checkbox"/> Under Frequency Magnitude <input type="checkbox"/> Under Frequency Trip Time	<input type="checkbox"/> First Over Voltage Magnitude <input type="checkbox"/> First Over Voltage Trip Time <input type="checkbox"/> First Under Voltage Magnitude <input type="checkbox"/> First Under Voltage Trip Time <input type="checkbox"/> Over Frequency Magnitude <input type="checkbox"/> Over Frequency Trip Time <input type="checkbox"/> Response to Utility Recovery	
Test description:	100% load, PR: 0%, QL: +5%, the trip time of protection was 307.00ms. CH1/2/7 were the output currents of the inverter; CH8/9/10 were the currents flowing through to the grid, also regarded as the trip signal while the grid was switched off. The wave No. was ordered from top to end.		



Used equipment No.: See equipment list for details      Sample No.: N/A

Finished date: \_\_\_\_\_      Tested by: \_\_\_\_\_

Review date: \_\_\_\_\_      Reviewed by: \_\_\_\_\_



# Compliance Evaluation Report



REPORT No.: CSSC/BOS/012

ISSUED DATE: August 20, 2021

APPENDIX C. TÜV Rheinland's Report No: CN21ZH49 001. (Cont.)

<b>Test Data / Test Plan</b>			
TÜV Rheinland (Shanghai) Co., Ltd.		Document No.: TD-0189	
Protection and Control requirements for PEA Interface of Inverter based Generation Systems 2016.08		Report No:	CN21ZH49 001
Order No. :	244313300	Product:	Grid-Connected PV Inverter
Client Name :	SolaX Power Network Technology (Zhejiang)Co.,Ltd	Model designation:	X3-Hybrid G4

## Attachment : 1

Picture No.:	13	Clause:	7
Test:	<input checked="" type="checkbox"/> Islanding Protection <input type="checkbox"/> Secondary Over Voltage Magnitude <input type="checkbox"/> Secondary Over Voltage Trip Time <input type="checkbox"/> Secondary Under Voltage Magnitude <input type="checkbox"/> Secondary Under Voltage Trip Time <input type="checkbox"/> Under Frequency Magnitude <input type="checkbox"/> Under Frequency Trip Time	<input type="checkbox"/> First Over Voltage Magnitude <input type="checkbox"/> First Over Voltage Trip Time <input type="checkbox"/> First Under Voltage Magnitude <input type="checkbox"/> First Under Voltage Trip Time <input type="checkbox"/> Over Frequency Magnitude <input type="checkbox"/> Over Frequency Trip Time <input type="checkbox"/> Response to Utility Recovery	
Test description:	100% load, PR: 0%, QL: 0%, the trip time of protection was 325.00ms. CH1/2/7 were the output currents of the inverter; CH8/9/10 were the currents flowing through to the grid, also regarded as the trip signal while the grid was switched off. The wave No. was ordered from top to end.		

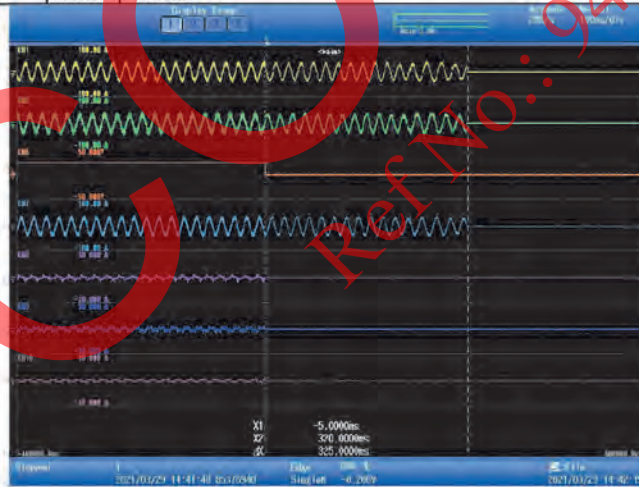

Used equipment No.: See equipment list for details      Sample No.: N/A

Finished date: \_\_\_\_\_      Tested by: \_\_\_\_\_

Review date: \_\_\_\_\_      Reviewed by: \_\_\_\_\_







# Compliance Evaluation Report



REPORT No.: CSSC/BOS/012

ISSUED DATE: August 20, 2021

APPENDIX C. TÜV Rheinland's Report No: CN21ZH49 001. (Cont.)

<b>Test Data / Test Plan</b>			
TÜV Rheinland (Shanghai) Co., Ltd.		Document No.: TD-0189	
Protection and Control requirements for PEA Interface of Inverter based Generation Systems 2016.08		Report No:	CN21ZH49 001
Order No. :	244313300	Product:	Grid-Connected PV Inverter
Client Name :	SolaX Power Network Technology (Zhejiang)Co.,Ltd	Model designation:	X3-Hybrid G4

## Attachment : 1

Picture No.:	14	Clause:	7
Test:	<input checked="" type="checkbox"/> Islanding Protection <input type="checkbox"/> Secondary Over Voltage Magnitude <input type="checkbox"/> Secondary Over Voltage Trip Time <input type="checkbox"/> Secondary Under Voltage Magnitude <input type="checkbox"/> Secondary Under Voltage Trip Time <input type="checkbox"/> Under Frequency Magnitude <input type="checkbox"/> Under Frequency Trip Time		<input type="checkbox"/> First Over Voltage Magnitude <input type="checkbox"/> First Over Voltage Trip Time <input type="checkbox"/> First Under Voltage Magnitude <input type="checkbox"/> First Under Voltage Trip Time <input type="checkbox"/> Over Frequency Magnitude <input type="checkbox"/> Over Frequency Trip Time <input type="checkbox"/> Response to Utility Recovery
Test description:	At the balance condition of 100% load, the fundamental magnitude of grid current in L1 was 25.7mA (1 <sup>st</sup> harmonic value), less than 1% of rated current 213mA. See screenshot of power analyzer for detail.		



Used equipment No.: See equipment list for details

Sample No.: N/A

Finished date:

Tested by:

Review date:

Reviewed by:





# Compliance Evaluation Report



REPORT No.: CSSC/BOS/012

ISSUED DATE: August 20, 2021

APPENDIX C. TÜV Rheinland's Report No: CN21ZH49 001. (Cont.)

<b>Test Data / Test Plan</b>			
TÜV Rheinland (Shanghai) Co., Ltd.		Document No.: TD-0189	
Protection and Control requirements for PEA Interface of Inverter based Generation Systems 2016.08		Report No:	CN21ZH49 001
Order No. :	244313300	Product:	Grid-Connected PV Inverter
Client Name :	SolaX Power Network Technology (Zhejiang)Co.,Ltd	Model designation:	X3-Hybrid G4

## Attachment : 1

Picture No.:	15	Clause:	7
Test:	<input checked="" type="checkbox"/> Islanding Protection <input type="checkbox"/> Secondary Over Voltage Magnitude <input type="checkbox"/> Secondary Over Voltage Trip Time <input type="checkbox"/> Secondary Under Voltage Magnitude <input type="checkbox"/> Secondary Under Voltage Trip Time <input type="checkbox"/> Under Frequency Magnitude <input type="checkbox"/> Under Frequency Trip Time		<input type="checkbox"/> First Over Voltage Magnitude <input type="checkbox"/> First Over Voltage Trip Time <input type="checkbox"/> First Under Voltage Magnitude <input type="checkbox"/> First Under Voltage Trip Time <input type="checkbox"/> Over Frequency Magnitude <input type="checkbox"/> Over Frequency Trip Time <input type="checkbox"/> Response to Utility Recovery
Test description:	At the balance condition of 100% load, the fundamental magnitude of grid current in L2 was 30mA (1 <sup>st</sup> harmonic value), less than 1% of rated current 213mA. See screenshot of power analyzer for detail.		

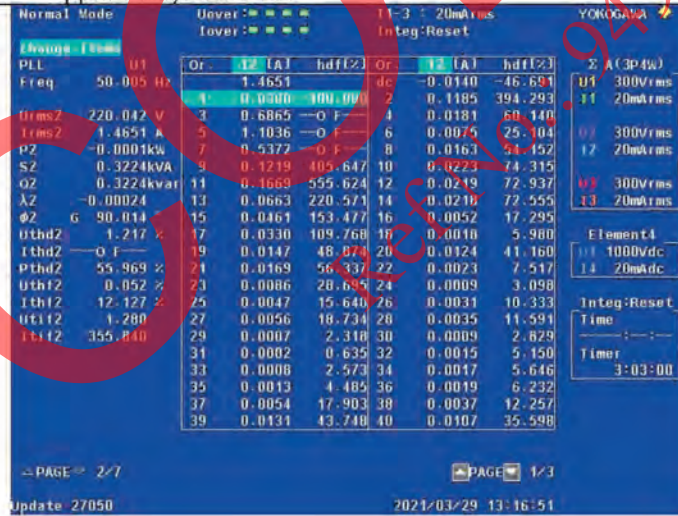

Used equipment No.: See equipment list for details  
 Finished date: \_\_\_\_\_  
 Review date: \_\_\_\_\_

Sample No.: N/A  
 Tested by: \_\_\_\_\_  
 Reviewed by: \_\_\_\_\_





# Compliance Evaluation Report



REPORT No.: CSSC/BOS/012

ISSUED DATE: August 20, 2021

APPENDIX C. TÜV Rheinland's Report No: CN21ZH49 001. (Cont.)

<b>Test Data / Test Plan</b>			
TÜV Rheinland (Shanghai) Co., Ltd.		Document No.: TD-0189	
Protection and Control requirements for PEA Interface of Inverter based Generation Systems 2016.08		Report No:	CN21ZH49 001
Order No. :	244313300	Product:	Grid-Connected PV Inverter
Client Name :	SolaX Power Network Technology (Zhejiang)Co.,Ltd	Model designation:	X3-Hybrid G4

## Attachment : 1

Picture No.:	16	Clause:	7
Test:	<input checked="" type="checkbox"/> Islanding Protection <input type="checkbox"/> Secondary Over Voltage Magnitude <input type="checkbox"/> Secondary Over Voltage Trip Time <input type="checkbox"/> Secondary Under Voltage Magnitude <input type="checkbox"/> Secondary Under Voltage Trip Time <input type="checkbox"/> Under Frequency Magnitude <input type="checkbox"/> Under Frequency Trip Time		<input type="checkbox"/> First Over Voltage Magnitude <input type="checkbox"/> First Over Voltage Trip Time <input type="checkbox"/> First Under Voltage Magnitude <input type="checkbox"/> First Under Voltage Trip Time <input type="checkbox"/> Over Frequency Magnitude <input type="checkbox"/> Over Frequency Trip Time <input type="checkbox"/> Response to Utility Recovery
Test description:	At the balance condition of 100% load, the fundamental magnitude of grid current in L3 was 73.3mA (1 <sup>st</sup> harmonic value), less than 1% of rated current 213mA. See screenshot of power analyzer for detail.		



Used equipment No.: See equipment list for details Sample No.: N/A

Finished date: \_\_\_\_\_ Tested by: \_\_\_\_\_

Review date: \_\_\_\_\_ Reviewed by: \_\_\_\_\_





# Compliance Evaluation Report



REPORT No.: CSSC/BOS/012

ISSUED DATE: August 20, 2021

APPENDIX C. TÜV Rheinland's Report No: CN21ZH49 001. (Cont.)

<b>Test Data / Test Plan</b>			
TÜV Rheinland (Shanghai) Co., Ltd.		Document No.: TD-0189	
Protection and Control requirements for PEA Interface of Inverter based Generation Systems 2016.08		Report No:	CN21ZH49 001
Order No. :	244313300	Product:	Grid-Connected PV Inverter
Client Name :	SolaX Power Network Technology (Zhejiang)Co.,Ltd	Model designation:	X3-Hybrid G4

## Attachment : 1

Picture No.:	17	Clause:	7
Test:	<input checked="" type="checkbox"/> Islanding Protection <input type="checkbox"/> Secondary Over Voltage Magnitude <input type="checkbox"/> Secondary Over Voltage Trip Time <input type="checkbox"/> Secondary Under Voltage Magnitude <input type="checkbox"/> Secondary Under Voltage Trip Time <input type="checkbox"/> Under Frequency Magnitude <input type="checkbox"/> Under Frequency Trip Time		<input type="checkbox"/> First Over Voltage Magnitude <input type="checkbox"/> First Over Voltage Trip Time <input type="checkbox"/> First Under Voltage Magnitude <input type="checkbox"/> First Under Voltage Trip Time <input type="checkbox"/> Over Frequency Magnitude <input type="checkbox"/> Over Frequency Trip Time <input type="checkbox"/> Response to Utility Recovery
Test description:	100% load, PR: 0%, QL: -5%, the trip time of protection was 298.00ms. CH1/2/7 were the output currents of the inverter; CH8/9/10 were the currents flowing through to the grid, also regarded as the trip signal while the grid was switched off. The wave No. was ordered from top to end.		



Used equipment No.: See equipment list for details      Sample No.: N/A

Finished date: \_\_\_\_\_      Tested by: \_\_\_\_\_

Review date: \_\_\_\_\_      Reviewed by: \_\_\_\_\_





# Compliance Evaluation Report



REPORT No.: CSSC/BOS/012

ISSUED DATE: August 20, 2021

APPENDIX C. TÜV Rheinland's Report No: CN21ZH49 001. (Cont.)

<b>Test Data / Test Plan</b>			
TÜV Rheinland (Shanghai) Co., Ltd.		Document No.: TD-0189	
Protection and Control requirements for PEA Interface of Inverter based Generation Systems 2016.08		Report No:	CN21ZH49 001
Order No. :	244313300	Product:	Grid-Connected PV Inverter
Client Name :	SolaX Power Network Technology (Zhejiang)Co.,Ltd	Model designation:	X3-Hybrid G4

## Attachment : 1

Picture No.:	18	Clause:	7
Test:	<input checked="" type="checkbox"/> Islanding Protection <input type="checkbox"/> Secondary Over Voltage Magnitude <input type="checkbox"/> Secondary Over Voltage Trip Time <input type="checkbox"/> Secondary Under Voltage Magnitude <input type="checkbox"/> Secondary Under Voltage Trip Time <input type="checkbox"/> Under Frequency Magnitude <input type="checkbox"/> Under Frequency Trip Time	<input type="checkbox"/> First Over Voltage Magnitude <input type="checkbox"/> First Over Voltage Trip Time <input type="checkbox"/> First Under Voltage Magnitude <input type="checkbox"/> First Under Voltage Trip Time <input type="checkbox"/> Over Frequency Magnitude <input type="checkbox"/> Over Frequency Trip Time <input type="checkbox"/> Response to Utility Recovery	
Test description:	100% load, PR: +5%, QL: +5%, the trip time of protection was 221.00ms. CH1/2/7 were the output currents of the inverter; CH8/9/10 were the currents flowing through to the grid, also regarded as the trip signal while the grid was switched off. The wave No. was ordered from top to end.		



Used equipment No.: See equipment list for details      Sample No.: N/A

Finished date: \_\_\_\_\_      Tested by: \_\_\_\_\_

Review date: \_\_\_\_\_      Reviewed by: \_\_\_\_\_





# Compliance Evaluation Report



REPORT No.: CSSC/BOS/012

ISSUED DATE: August 20, 2021

APPENDIX C. TÜV Rheinland's Report No: CN21ZH49 001. (Cont.)

<b>Test Data / Test Plan</b>			
TÜV Rheinland (Shanghai) Co., Ltd.		Document No.: TD-0189	
Protection and Control requirements for PEA Interface of Inverter based Generation Systems 2016.08		Report No:	CN21ZH49 001
Order No. :	244313300	Product:	Grid-Connected PV Inverter
Client Name :	SolaX Power Network Technology (Zhejiang)Co.,Ltd	Model designation:	X3-Hybrid G4

## Attachment : 1

Picture No.:	19	Clause:	7
Test:	<input checked="" type="checkbox"/> Islanding Protection <input type="checkbox"/> Secondary Over Voltage Magnitude <input type="checkbox"/> Secondary Over Voltage Trip Time <input type="checkbox"/> Secondary Under Voltage Magnitude <input type="checkbox"/> Secondary Under Voltage Trip Time <input type="checkbox"/> Under Frequency Magnitude <input type="checkbox"/> Under Frequency Trip Time		<input type="checkbox"/> First Over Voltage Magnitude <input type="checkbox"/> First Over Voltage Trip Time <input type="checkbox"/> First Under Voltage Magnitude <input type="checkbox"/> First Under Voltage Trip Time <input type="checkbox"/> Over Frequency Magnitude <input type="checkbox"/> Over Frequency Trip Time <input type="checkbox"/> Response to Utility Recovery
Test description:	100% load, PR: +5%, QL: 0%, the trip time of protection was 146.00ms. CH1/2/7 were the output currents of the inverter; CH8/9/10 were the currents flowing through to the grid, also regarded as the trip signal while the grid was switched off. The wave No. was orded from top to end.		



Used equipment No.: See equipment list for details      Sample No.: N/A

Finished date: \_\_\_\_\_      Tested by: \_\_\_\_\_

Review date: \_\_\_\_\_      Reviewed by: \_\_\_\_\_





# Compliance Evaluation Report



REPORT No.: CSSC/BOS/012

ISSUED DATE: August 20, 2021

APPENDIX C. TÜV Rheinland's Report No: CN21ZH49 001. (Cont.)

<b>Test Data / Test Plan</b>			
TÜV Rheinland (Shanghai) Co., Ltd.		Document No.: TD-0189	
Protection and Control requirements for PEA Interface of Inverter based Generation Systems 2016.08		Report No:	CN21ZH49 001
Order No. :	244313300	Product:	Grid-Connected PV Inverter
Client Name :	SolaX Power Network Technology (Zhejiang)Co.,Ltd	Model designation:	X3-Hybrid G4

## Attachment : 1

Picture No.:	20	Clause:	7
Test:	<input checked="" type="checkbox"/> Islanding Protection <input type="checkbox"/> Secondary Over Voltage Magnitude <input type="checkbox"/> Secondary Over Voltage Trip Time <input type="checkbox"/> Secondary Under Voltage Magnitude <input type="checkbox"/> Secondary Under Voltage Trip Time <input type="checkbox"/> Under Frequency Magnitude <input type="checkbox"/> Under Frequency Trip Time		<input type="checkbox"/> First Over Voltage Magnitude <input type="checkbox"/> First Over Voltage Trip Time <input type="checkbox"/> First Under Voltage Magnitude <input type="checkbox"/> First Under Voltage Trip Time <input type="checkbox"/> Over Frequency Magnitude <input type="checkbox"/> Over Frequency Trip Time <input type="checkbox"/> Response to Utility Recovery
Test description:	100% load, PR: +5%, QL: -5%, the trip time of protection was 119.00ms. CH1/2/7 were the output currents of the inverter; CH8/9/10 were the currents flowing through to the grid, also regarded as the trip signal while the grid was switched off. The wave No. was ordered from top to end.		



Used equipment No.: See equipment list for details      Sample No.: N/A

Finished date: \_\_\_\_\_      Tested by: \_\_\_\_\_

Review date: \_\_\_\_\_      Reviewed by: \_\_\_\_\_





# Compliance Evaluation Report



REPORT No.: CSSC/BOS/012

ISSUED DATE: August 20, 2021

APPENDIX C. TÜV Rheinland's Report No: CN21ZH49 001. (Cont.)

<b>Test Data / Test Plan</b>			
TÜV Rheinland (Shanghai) Co., Ltd.		Document No.: TD-0189	
Protection and Control requirements for PEA Interface of Inverter based Generation Systems 2016.08		Report No:	CN21ZH49 001
Order No. :	244313300	Product:	Grid-Connected PV Inverter
Client Name :	SolaX Power Network Technology (Zhejiang)Co.,Ltd	Model designation:	X3-Hybrid G4

## Attachment : 1

Picture No.:	21	Clause:	7
Test:	<input checked="" type="checkbox"/> Islanding Protection <input type="checkbox"/> Secondary Over Voltage Magnitude <input type="checkbox"/> Secondary Over Voltage Trip Time <input type="checkbox"/> Secondary Under Voltage Magnitude <input type="checkbox"/> Secondary Under Voltage Trip Time <input type="checkbox"/> Under Frequency Magnitude <input type="checkbox"/> Under Frequency Trip Time	<input type="checkbox"/> First Over Voltage Magnitude <input type="checkbox"/> First Over Voltage Trip Time <input type="checkbox"/> First Under Voltage Magnitude <input type="checkbox"/> First Under Voltage Trip Time <input type="checkbox"/> Over Frequency Magnitude <input type="checkbox"/> Over Frequency Trip Time <input type="checkbox"/> Response to Utility Recovery	
Test description:	100% load, PR: 0%, QL: -10%, the trip time of protection was 115.00ms. CH1/2/7 were the output currents of the inverter; CH8/9/10 were the currents flowing through to the grid, also regarded as the trip signal while the grid was switched off. The wave No. was ordered from top to end.		



Used equipment No.: See equipment list for details      Sample No.: N/A

Finished date: \_\_\_\_\_      Tested by: \_\_\_\_\_

Review date: \_\_\_\_\_      Reviewed by: \_\_\_\_\_







# Compliance Evaluation Report



REPORT No.: CSSC/BOS/012

ISSUED DATE: August 20, 2021

APPENDIX C. TÜV Rheinland's Report No: CN21ZH49 001. (Cont.)

<b>Test Data / Test Plan</b>			
TÜV Rheinland (Shanghai) Co., Ltd.		Document No.: TD-0189	
Protection and Control requirements for PEA Interface of Inverter based Generation Systems 2016.08		Report No:	CN21ZH49 001
Order No. :	244313300	Product:	Grid-Connected PV Inverter
Client Name :	SolaX Power Network Technology (Zhejiang)Co.,Ltd	Model designation:	X3-Hybrid G4

## Attachment : 1

Picture No.:	22	Clause:	7
Test:	<input checked="" type="checkbox"/> Islanding Protection <input type="checkbox"/> Secondary Over Voltage Magnitude <input type="checkbox"/> Secondary Over Voltage Trip Time <input type="checkbox"/> Secondary Under Voltage Magnitude <input type="checkbox"/> Secondary Under Voltage Trip Time <input type="checkbox"/> Under Frequency Magnitude <input type="checkbox"/> Under Frequency Trip Time		<input type="checkbox"/> First Over Voltage Magnitude <input type="checkbox"/> First Over Voltage Trip Time <input type="checkbox"/> First Under Voltage Magnitude <input type="checkbox"/> First Under Voltage Trip Time <input type="checkbox"/> Over Frequency Magnitude <input type="checkbox"/> Over Frequency Trip Time <input type="checkbox"/> Response to Utility Recovery
Test description:	100% load, PR: +5%, QL: +10%, the trip time of protection was 110.00ms. CH1/2/7 were the output currents of the inverter; CH8/9/10 were the currents flowing through to the grid, also regarded as the trip signal while the grid was switched off. The wave No. was ordered from top to end.		



Used equipment No.: See equipment list for details      Sample No.: N/A

Finished date: \_\_\_\_\_      Tested by: \_\_\_\_\_

Review date: \_\_\_\_\_      Reviewed by: \_\_\_\_\_





# Compliance Evaluation Report



REPORT No.: CSSC/BOS/012

ISSUED DATE: August 20, 2021

APPENDIX C. TÜV Rheinland's Report No: CN21ZH49 001. (Cont.)

<b>Test Data / Test Plan</b>			
TÜV Rheinland (Shanghai) Co., Ltd.		Document No.: TD-0189	
Protection and Control requirements for PEA Interface of Inverter based Generation Systems 2016.08		Report No:	CN21ZH49 001
Order No. :	244313300	Product:	Grid-Connected PV Inverter
Client Name :	SolaX Power Network Technology (Zhejiang)Co.,Ltd	Model designation:	X3-Hybrid G4

## Attachment : 1

Picture No.:	23	Clause:	7
Test:	<input checked="" type="checkbox"/> Islanding Protection <input type="checkbox"/> Secondary Over Voltage Magnitude <input type="checkbox"/> Secondary Over Voltage Trip Time <input type="checkbox"/> Secondary Under Voltage Magnitude <input type="checkbox"/> Secondary Under Voltage Trip Time <input type="checkbox"/> Under Frequency Magnitude <input type="checkbox"/> Under Frequency Trip Time	<input type="checkbox"/> First Over Voltage Magnitude <input type="checkbox"/> First Over Voltage Trip Time <input type="checkbox"/> First Under Voltage Magnitude <input type="checkbox"/> First Under Voltage Trip Time <input type="checkbox"/> Over Frequency Magnitude <input type="checkbox"/> Over Frequency Trip Time <input type="checkbox"/> Response to Utility Recovery	
Test description:	100% load, PR: +5%, QL: -10%, the trip time of protection was 108.00ms. CH1/2/7 were the output currents of the inverter; CH8/9/10 were the currents flowing through to the grid, also regarded as the trip signal while the grid was switched off. The wave No. was ordered from top to end.		



Used equipment No.: See equipment list for details      Sample No.: N/A  
 Finished date: \_\_\_\_\_      Tested by: \_\_\_\_\_  
 Review date: \_\_\_\_\_      Reviewed by: \_\_\_\_\_





# Compliance Evaluation Report



REPORT No.: CSSC/BOS/012

ISSUED DATE: August 20, 2021

APPENDIX C. TÜV Rheinland's Report No: CN21ZH49 001. (Cont.)

<b>Test Data / Test Plan</b>			
TÜV Rheinland (Shanghai) Co., Ltd.		Document No.: TD-0189	
Protection and Control requirements for PEA Interface of Inverter based Generation Systems 2016.08		Report No:	CN21ZH49 001
Order No. :	244313300	Product:	Grid-Connected PV Inverter
Client Name :	SolaX Power Network Technology (Zhejiang)Co.,Ltd	Model designation:	X3-Hybrid G4

## Attachment : 1

Picture No.:	24	Clause:	7
Test:	<input checked="" type="checkbox"/> Islanding Protection <input type="checkbox"/> Secondary Over Voltage Magnitude <input type="checkbox"/> Secondary Over Voltage Trip Time <input type="checkbox"/> Secondary Under Voltage Magnitude <input type="checkbox"/> Secondary Under Voltage Trip Time <input type="checkbox"/> Under Frequency Magnitude <input type="checkbox"/> Under Frequency Trip Time		<input type="checkbox"/> First Over Voltage Magnitude <input type="checkbox"/> First Over Voltage Trip Time <input type="checkbox"/> First Under Voltage Magnitude <input type="checkbox"/> First Under Voltage Trip Time <input type="checkbox"/> Over Frequency Magnitude <input type="checkbox"/> Over Frequency Trip Time <input type="checkbox"/> Response to Utility Recovery
Test description:	100% load, PR: +10%, QL: +10%, the trip time of protection was 108.00ms. CH1/2/7 were the output currents of the inverter, CH8/9/10 were the currents flowing through to the grid, also regarded as the trip signal while the grid was switched off. The wave No. was ordered from top to end.		



Used equipment No.:	See equipment list for details	Sample No.:	N/A
Finished date:	_____	Tested by:	_____
Review date:	_____	Reviewed by:	_____





# Compliance Evaluation Report



REPORT No.: CSSC/BOS/012

ISSUED DATE: August 20, 2021

APPENDIX C. TÜV Rheinland's Report No: CN21ZH49 001. (Cont.)

<b>Test Data / Test Plan</b>			
TÜV Rheinland (Shanghai) Co., Ltd.		Document No.: TD-0189	
Protection and Control requirements for PEA Interface of Inverter based Generation Systems 2016.08		Report No:	CN21ZH49 001
Order No. :	244313300	Product:	Grid-Connected PV Inverter
Client Name :	SolaX Power Network Technology (Zhejiang)Co.,Ltd	Model designation:	X3-Hybrid G4

## Attachment : 1

Picture No.:	25	Clause:	7
Test:	<input checked="" type="checkbox"/> Islanding Protection <input type="checkbox"/> Secondary Over Voltage Magnitude <input type="checkbox"/> Secondary Over Voltage Trip Time <input type="checkbox"/> Secondary Under Voltage Magnitude <input type="checkbox"/> Secondary Under Voltage Trip Time <input type="checkbox"/> Under Frequency Magnitude <input type="checkbox"/> Under Frequency Trip Time	<input type="checkbox"/> First Over Voltage Magnitude <input type="checkbox"/> First Over Voltage Trip Time <input type="checkbox"/> First Under Voltage Magnitude <input type="checkbox"/> First Under Voltage Trip Time <input type="checkbox"/> Over Frequency Magnitude <input type="checkbox"/> Over Frequency Trip Time <input type="checkbox"/> Response to Utility Recovery	
Test description:	100% load, PR: +10%, QL: +5%, the trip time of protection was 105.00ms. CH1/2/7 were the output currents of the inverter; CH8/9/10 were the currents flowing through to the grid, also regarded as the trip signal while the grid was switched off. The wave No. was ordered from top to end.		



Used equipment No.:	See equipment list for details	Sample No.:	N/A
Finished date:	_____	Tested by:	_____
Review date:	_____	Reviewed by:	_____





# Compliance Evaluation Report



REPORT No.: CSSC/BOS/012

ISSUED DATE: August 20, 2021

APPENDIX C. TÜV Rheinland's Report No: CN21ZH49 001. (Cont.)

<b>Test Data / Test Plan</b>			
TÜV Rheinland (Shanghai) Co., Ltd.		Document No.: TD-0189	
Protection and Control requirements for PEA Interface of Inverter based Generation Systems 2016.08		Report No:	CN21ZH49 001
Order No. :	244313300	Product:	Grid-Connected PV Inverter
Client Name :	SolaX Power Network Technology (Zhejiang)Co.,Ltd	Model designation:	X3-Hybrid G4

## Attachment : 1

Picture No.:	26	Clause:	7
Test:	<input checked="" type="checkbox"/> Islanding Protection <input type="checkbox"/> Secondary Over Voltage Magnitude <input type="checkbox"/> Secondary Over Voltage Trip Time <input type="checkbox"/> Secondary Under Voltage Magnitude <input type="checkbox"/> Secondary Under Voltage Trip Time <input type="checkbox"/> Under Frequency Magnitude <input type="checkbox"/> Under Frequency Trip Time	<input type="checkbox"/> First Over Voltage Magnitude <input type="checkbox"/> First Over Voltage Trip Time <input type="checkbox"/> First Under Voltage Magnitude <input type="checkbox"/> First Under Voltage Trip Time <input type="checkbox"/> Over Frequency Magnitude <input type="checkbox"/> Over Frequency Trip Time <input type="checkbox"/> Response to Utility Recovery	
Test description:	100% load, PR: +10%, QL: 0%, the trip time of protection was 103.00ms. CH1/2/7 were the output currents of the inverter; CH8/9/10 were the currents flowing through to the grid, also regarded as the trip signal while the grid was switched off. The wave No. was ordered from top to end.		



Used equipment No.: See equipment list for details      Sample No.: N/A

Finished date: \_\_\_\_\_      Tested by: \_\_\_\_\_

Review date: \_\_\_\_\_      Reviewed by: \_\_\_\_\_





# Compliance Evaluation Report



REPORT No.: CSSC/BOS/012

ISSUED DATE: August 20, 2021

APPENDIX C. TÜV Rheinland's Report No: CN21ZH49 001. (Cont.)

<b>Test Data / Test Plan</b>			
TÜV Rheinland (Shanghai) Co., Ltd.		Document No.: TD-0189	
Protection and Control requirements for PEA Interface of Inverter based Generation Systems 2016.08		Report No:	CN21ZH49 001
Order No. :	244313300	Product:	Grid-Connected PV Inverter
Client Name :	SolaX Power Network Technology (Zhejiang)Co.,Ltd	Model designation:	X3-Hybrid G4

## Attachment : 1

Picture No.:	27	Clause:	7
Test:	<input checked="" type="checkbox"/> Islanding Protection <input type="checkbox"/> Secondary Over Voltage Magnitude <input type="checkbox"/> Secondary Over Voltage Trip Time <input type="checkbox"/> Secondary Under Voltage Magnitude <input type="checkbox"/> Secondary Under Voltage Trip Time <input type="checkbox"/> Under Frequency Magnitude <input type="checkbox"/> Under Frequency Trip Time		<input type="checkbox"/> First Over Voltage Magnitude <input type="checkbox"/> First Over Voltage Trip Time <input type="checkbox"/> First Under Voltage Magnitude <input type="checkbox"/> First Under Voltage Trip Time <input type="checkbox"/> Over Frequency Magnitude <input type="checkbox"/> Over Frequency Trip Time <input type="checkbox"/> Response to Utility Recovery
Test description:	100% load, PR: +10%, QL: -5%, the trip time of protection was 100.00ms. CH1/2/7 were the output currents of the inverter; CH8/9/10 were the currents flowing through to the grid, also regarded as the trip signal while the grid was switched off. The wave No. was ordered from top to end.		



Used equipment No.: See equipment list for details      Sample No.: N/A  
 Finished date: \_\_\_\_\_      Tested by: \_\_\_\_\_  
 Review date: \_\_\_\_\_      Reviewed by: \_\_\_\_\_





# Compliance Evaluation Report



REPORT No.: CSSC/BOS/012

ISSUED DATE: August 20, 2021

APPENDIX C. TÜV Rheinland's Report No: CN21ZH49 001. (Cont.)

<b>Test Data / Test Plan</b>			
TÜV Rheinland (Shanghai) Co., Ltd.		Document No.: TD-0189	
Protection and Control requirements for PEA Interface of Inverter based Generation Systems 2016.08		Report No:	CN21ZH49 001
Order No. :	244313300	Product:	Grid-Connected PV Inverter
Client Name :	SolaX Power Network Technology (Zhejiang)Co.,Ltd	Model designation:	X3-Hybrid G4

## Attachment : 1

Picture No.:	28	Clause:	7
Test:	<input checked="" type="checkbox"/> Islanding Protection <input type="checkbox"/> Secondary Over Voltage Magnitude <input type="checkbox"/> Secondary Over Voltage Trip Time <input type="checkbox"/> Secondary Under Voltage Magnitude <input type="checkbox"/> Secondary Under Voltage Trip Time <input type="checkbox"/> Under Frequency Magnitude <input type="checkbox"/> Under Frequency Trip Time	<input type="checkbox"/> First Over Voltage Magnitude <input type="checkbox"/> First Over Voltage Trip Time <input type="checkbox"/> First Under Voltage Magnitude <input type="checkbox"/> First Under Voltage Trip Time <input type="checkbox"/> Over Frequency Magnitude <input type="checkbox"/> Over Frequency Trip Time <input type="checkbox"/> Response to Utility Recovery	
Test description:	100% load, PR: +10%, QL: -10%, the trip time of protection was 88.00ms. CH1/2/7 were the output currents of the inverter; CH8/9/10 were the currents flowing through to the grid, also regarded as the trip signal while the grid was switched off. The wave No. was orded from top to end.		



Used equipment No.: See equipment list for details

Sample No.: N/A

Finished date:

Tested by:

Review date:

Reviewed by:



# Compliance Evaluation Report



REPORT No.: CSSC/BOS/012

ISSUED DATE: August 20, 2021

APPENDIX C. TÜV Rheinland's Report No: CN21ZH49 001. (Cont.)

<b>Test Data / Test Plan</b>			
TÜV Rheinland (Shanghai) Co., Ltd.		Document No.: TD-0189	
Protection and Control requirements for PEA Interface of Inverter based Generation Systems 2016.08		Report No:	CN21ZH49 001
Order No. :	244313300	Product:	Grid-Connected PV Inverter
Client Name :	SolaX Power Network Technology (Zhejiang)Co.,Ltd	Model designation:	X3-Hybrid G4

## Attachment : 1

Picture No.:	29	Clause:	7
Test:	<input checked="" type="checkbox"/> Islanding Protection <input type="checkbox"/> Secondary Over Voltage Magnitude <input type="checkbox"/> Secondary Over Voltage Trip Time <input type="checkbox"/> Secondary Under Voltage Magnitude <input type="checkbox"/> Secondary Under Voltage Trip Time <input type="checkbox"/> Under Frequency Magnitude <input type="checkbox"/> Under Frequency Trip Time		<input type="checkbox"/> First Over Voltage Magnitude <input type="checkbox"/> First Over Voltage Trip Time <input type="checkbox"/> First Under Voltage Magnitude <input type="checkbox"/> First Under Voltage Trip Time <input type="checkbox"/> Over Frequency Magnitude <input type="checkbox"/> Over Frequency Trip Time <input type="checkbox"/> Response to Utility Recovery
Test description:	66% load, PR: 0%, QL: -5%, the trip time of protection was 131.0ms. CH1/2/7 were the output currents of the inverter; CH8/9/10 were the currents flowing through to the grid, also regarded as the trip signal while the grid was switched off. The wave No. was ordered from top to end.		



Used equipment No.: See equipment list for details      Sample No.: N/A

Finished date: \_\_\_\_\_      Tested by: \_\_\_\_\_

Review date: \_\_\_\_\_      Reviewed by: \_\_\_\_\_







# Compliance Evaluation Report



REPORT No.: CSSC/BOS/012

ISSUED DATE: August 20, 2021

APPENDIX C. TÜV Rheinland's Report No: CN21ZH49 001. (Cont.)

<b>Test Data / Test Plan</b>			
TÜV Rheinland (Shanghai) Co., Ltd.		Document No.: TD-0189	
Protection and Control requirements for PEA Interface of Inverter based Generation Systems 2016.08		Report No:	CN21ZH49 001
Order No. :	244313300	Product:	Grid-Connected PV Inverter
Client Name :	SolaX Power Network Technology (Zhejiang)Co.,Ltd	Model designation:	X3-Hybrid G4

## Attachment : 1

Picture No.:	30	Clause:	7
Test:	<input checked="" type="checkbox"/> Islanding Protection <input type="checkbox"/> Secondary Over Voltage Magnitude <input type="checkbox"/> Secondary Over Voltage Trip Time <input type="checkbox"/> Secondary Under Voltage Magnitude <input type="checkbox"/> Secondary Under Voltage Trip Time <input type="checkbox"/> Under Frequency Magnitude <input type="checkbox"/> Under Frequency Trip Time	<input type="checkbox"/> First Over Voltage Magnitude <input type="checkbox"/> First Over Voltage Trip Time <input type="checkbox"/> First Under Voltage Magnitude <input type="checkbox"/> First Under Voltage Trip Time <input type="checkbox"/> Over Frequency Magnitude <input type="checkbox"/> Over Frequency Trip Time <input type="checkbox"/> Response to Utility Recovery	
Test description:	66% load, PR: 0%, QL: -4%, the trip time of protection was 141.00ms. CH1/2/7 were the output currents of the inverter; CH8/9/10 were the currents flowing through to the grid, also regarded as the trip signal while the grid was switched off. The wave No. was ordered from top to end.		

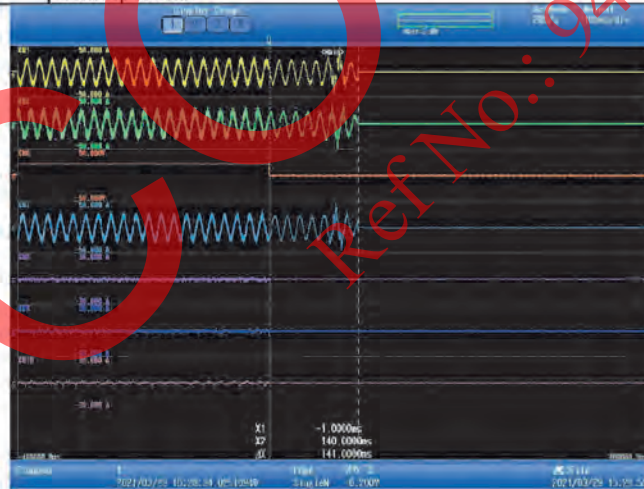

Used equipment No.: See equipment list for details      Sample No.: N/A

Finished date: \_\_\_\_\_      Tested by: \_\_\_\_\_

Review date: \_\_\_\_\_      Reviewed by: \_\_\_\_\_





# Compliance Evaluation Report



REPORT No.: CSSC/BOS/012

ISSUED DATE: August 20, 2021

APPENDIX C. TÜV Rheinland's Report No: CN21ZH49 001. (Cont.)

<b>Test Data / Test Plan</b>			
TÜV Rheinland (Shanghai) Co., Ltd.		Document No.: TD-0189	
Protection and Control requirements for PEA Interface of Inverter based Generation Systems 2016.08		Report No:	CN21ZH49 001
Order No. :	244313300	Product:	Grid-Connected PV Inverter
Client Name :	SolaX Power Network Technology (Zhejiang)Co.,Ltd	Model designation:	X3-Hybrid G4

## Attachment : 1

Picture No.:	31	Clause:	7
Test:	<input checked="" type="checkbox"/> Islanding Protection <input type="checkbox"/> Secondary Over Voltage Magnitude <input type="checkbox"/> Secondary Over Voltage Trip Time <input type="checkbox"/> Secondary Under Voltage Magnitude <input type="checkbox"/> Secondary Under Voltage Trip Time <input type="checkbox"/> Under Frequency Magnitude <input type="checkbox"/> Under Frequency Trip Time	<input type="checkbox"/> First Over Voltage Magnitude <input type="checkbox"/> First Over Voltage Trip Time <input type="checkbox"/> First Under Voltage Magnitude <input type="checkbox"/> First Under Voltage Trip Time <input type="checkbox"/> Over Frequency Magnitude <input type="checkbox"/> Over Frequency Trip Time <input type="checkbox"/> Response to Utility Recovery	
Test description:	66% load, PR: 0%, QL: -3%, the trip time of protection was 192.0ms. CH1/2/7 were the output currents of the inverter; CH8/9/10 were the currents flowing through to the grid, also regarded as the trip signal while the grid was switched off. The wave No. was ordered from top to end.		



Used equipment No.: See equipment list for details      Sample No.: N/A

Finished date: \_\_\_\_\_      Tested by: \_\_\_\_\_

Review date: \_\_\_\_\_      Reviewed by: \_\_\_\_\_



# Compliance Evaluation Report



REPORT No.: CSSC/BOS/012

ISSUED DATE: August 20, 2021

APPENDIX C. TÜV Rheinland's Report No: CN21ZH49 001. (Cont.)

<b>Test Data / Test Plan</b>			
TÜV Rheinland (Shanghai) Co., Ltd.		Document No.: TD-0189	
Protection and Control requirements for PEA Interface of Inverter based Generation Systems 2016.08		Report No:	CN21ZH49 001
Order No. :	244313300	Product:	Grid-Connected PV Inverter
Client Name :	SolaX Power Network Technology (Zhejiang)Co.,Ltd	Model designation:	X3-Hybrid G4

## Attachment : 1

Picture No.:	32	Clause:	7
Test:	<input checked="" type="checkbox"/> Islanding Protection <input type="checkbox"/> Secondary Over Voltage Magnitude <input type="checkbox"/> Secondary Over Voltage Trip Time <input type="checkbox"/> Secondary Under Voltage Magnitude <input type="checkbox"/> Secondary Under Voltage Trip Time <input type="checkbox"/> Under Frequency Magnitude <input type="checkbox"/> Under Frequency Trip Time	<input type="checkbox"/> First Over Voltage Magnitude <input type="checkbox"/> First Over Voltage Trip Time <input type="checkbox"/> First Under Voltage Magnitude <input type="checkbox"/> First Under Voltage Trip Time <input type="checkbox"/> Over Frequency Magnitude <input type="checkbox"/> Over Frequency Trip Time <input type="checkbox"/> Response to Utility Recovery	
Test description:	66% load, PR: 0%, QL: -2%, the trip time of protection was 301.00ms. CH1/2/7 were the output currents of the inverter; CH8/9/10 were the currents flowing through to the grid, also regarded as the trip signal while the grid was switched off. The wave No. was ordered from top to end.		



Used equipment No.: See equipment list for details      Sample No.: N/A  
 Finished date: \_\_\_\_\_      Tested by: \_\_\_\_\_  
 Review date: \_\_\_\_\_      Reviewed by: \_\_\_\_\_





# Compliance Evaluation Report



REPORT No.: CSSC/BOS/012

ISSUED DATE: August 20, 2021

APPENDIX C. TÜV Rheinland's Report No: CN21ZH49 001. (Cont.)

<b>Test Data / Test Plan</b>			
TÜV Rheinland (Shanghai) Co., Ltd.		Document No.: TD-0189	
Protection and Control requirements for PEA Interface of Inverter based Generation Systems 2016.08		Report No:	CN21ZH49 001
Order No. :	244313300	Product:	Grid-Connected PV Inverter
Client Name :	SolaX Power Network Technology (Zhejiang)Co.,Ltd	Model designation:	X3-Hybrid G4

## Attachment : 1

Picture No.:	33	Clause:	7
Test:	<input checked="" type="checkbox"/> Islanding Protection <input type="checkbox"/> Secondary Over Voltage Magnitude <input type="checkbox"/> Secondary Over Voltage Trip Time <input type="checkbox"/> Secondary Under Voltage Magnitude <input type="checkbox"/> Secondary Under Voltage Trip Time <input type="checkbox"/> Under Frequency Magnitude <input type="checkbox"/> Under Frequency Trip Time		<input type="checkbox"/> First Over Voltage Magnitude <input type="checkbox"/> First Over Voltage Trip Time <input type="checkbox"/> First Under Voltage Magnitude <input type="checkbox"/> First Under Voltage Trip Time <input type="checkbox"/> Over Frequency Magnitude <input type="checkbox"/> Over Frequency Trip Time <input type="checkbox"/> Response to Utility Recovery
Test description:	66% load, PR: 0%, QL: -1%, the trip time of protection was 386.0ms. CH1/2/7 were the output currents of the inverter; CH8/9/10 were the currents flowing through to the grid, also regarded as the trip signal while the grid was switched off. The wave No. was ordered from top to end.		



Used equipment No.: See equipment list for details      Sample No.: N/A  
 Finished date: \_\_\_\_\_      Tested by: \_\_\_\_\_  
 Review date: \_\_\_\_\_      Reviewed by: \_\_\_\_\_





# Compliance Evaluation Report



REPORT No.: CSSC/BOS/012

ISSUED DATE: August 20, 2021

APPENDIX C. TÜV Rheinland's Report No: CN21ZH49 001. (Cont.)

<b>Test Data / Test Plan</b>			
TÜV Rheinland (Shanghai) Co., Ltd.		Document No.: TD-0189	
Protection and Control requirements for PEA Interface of Inverter based Generation Systems 2016.08		Report No:	CN21ZH49 001
Order No. :	244313300	Product:	Grid-Connected PV Inverter
Client Name :	SolaX Power Network Technology (Zhejiang)Co.,Ltd	Model designation:	X3-Hybrid G4

## Attachment : 1

Picture No.:	34	Clause:	7
Test:	<input checked="" type="checkbox"/> Islanding Protection <input type="checkbox"/> Secondary Over Voltage Magnitude <input type="checkbox"/> Secondary Over Voltage Trip Time <input type="checkbox"/> Secondary Under Voltage Magnitude <input type="checkbox"/> Secondary Under Voltage Trip Time <input type="checkbox"/> Under Frequency Magnitude <input type="checkbox"/> Under Frequency Trip Time	<input type="checkbox"/> First Over Voltage Magnitude <input type="checkbox"/> First Over Voltage Trip Time <input type="checkbox"/> First Under Voltage Magnitude <input type="checkbox"/> First Under Voltage Trip Time <input type="checkbox"/> Over Frequency Magnitude <input type="checkbox"/> Over Frequency Trip Time <input type="checkbox"/> Response to Utility Recovery	
Test description:	66% load, PR: 0%, QL: 0%, the trip time of protection was 452ms. CH1/2/7 were the output currents of the inverter; CH8/9/10 were the currents flowing through to the grid, also regarded as the trip signal while the grid was switched off. The wave No. was ordered from top to end.		

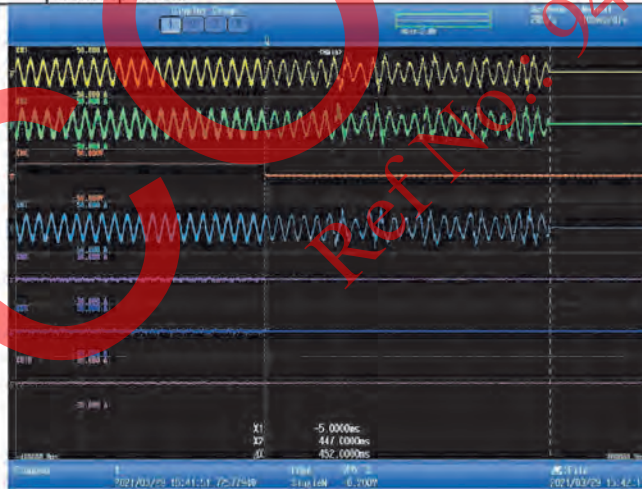

Used equipment No.: See equipment list for details      Sample No.: N/A

Finished date: \_\_\_\_\_      Tested by: \_\_\_\_\_

Review date: \_\_\_\_\_      Reviewed by: \_\_\_\_\_



# Compliance Evaluation Report



REPORT No.: CSSC/BOS/012

ISSUED DATE: August 20, 2021

APPENDIX C. TÜV Rheinland's Report No: CN21ZH49 001. (Cont.)

<b>Test Data / Test Plan</b>			
TÜV Rheinland (Shanghai) Co., Ltd.		Document No.: TD-0189	
Protection and Control requirements for PEA Interface of Inverter based Generation Systems 2016.08		Report No:	CN21ZH49 001
Order No. :	244313300	Product:	Grid-Connected PV Inverter
Client Name :	SolaX Power Network Technology (Zhejiang)Co.,Ltd	Model designation:	X3-Hybrid G4

## Attachment : 1

Picture No.:	35	Clause:	7
Test:	<input checked="" type="checkbox"/> Islanding Protection <input type="checkbox"/> Secondary Over Voltage Magnitude <input type="checkbox"/> Secondary Over Voltage Trip Time <input type="checkbox"/> Secondary Under Voltage Magnitude <input type="checkbox"/> Secondary Under Voltage Trip Time <input type="checkbox"/> Under Frequency Magnitude <input type="checkbox"/> Under Frequency Trip Time		<input type="checkbox"/> First Over Voltage Magnitude <input type="checkbox"/> First Over Voltage Trip Time <input type="checkbox"/> First Under Voltage Magnitude <input type="checkbox"/> First Under Voltage Trip Time <input type="checkbox"/> Over Frequency Magnitude <input type="checkbox"/> Over Frequency Trip Time <input type="checkbox"/> Response to Utility Recovery
Test description:	At the balance condition of 66% load, the fundamental magnitude of grid current in L1 (1 <sup>st</sup> harmonic current) was 46.2mA, less than 1% of the rated current 213 mA. See screenshot of power analyzer for detail.		



Used equipment No.: See equipment list for details Sample No.: N/A

Finished date: \_\_\_\_\_ Tested by: \_\_\_\_\_

Review date: \_\_\_\_\_ Reviewed by: \_\_\_\_\_





# Compliance Evaluation Report



REPORT No.: CSSC/BOS/012

ISSUED DATE: August 20, 2021

APPENDIX C. TÜV Rheinland's Report No: CN21ZH49 001. (Cont.)

<b>Test Data / Test Plan</b>			
TÜV Rheinland (Shanghai) Co., Ltd.		Document No.: TD-0189	
Protection and Control requirements for PEA Interface of Inverter based Generation Systems 2016.08		Report No:	CN21ZH49 001
Order No. :	244313300	Product:	Grid-Connected PV Inverter
Client Name :	SolaX Power Network Technology (Zhejiang)Co.,Ltd	Model designation:	X3-Hybrid G4

## Attachment : 1

Picture No.:	36	Clause:	7
Test:	<input checked="" type="checkbox"/> Islanding Protection <input type="checkbox"/> Secondary Over Voltage Magnitude <input type="checkbox"/> Secondary Over Voltage Trip Time <input type="checkbox"/> Secondary Under Voltage Magnitude <input type="checkbox"/> Secondary Under Voltage Trip Time <input type="checkbox"/> Under Frequency Magnitude <input type="checkbox"/> Under Frequency Trip Time		<input type="checkbox"/> First Over Voltage Magnitude <input type="checkbox"/> First Over Voltage Trip Time <input type="checkbox"/> First Under Voltage Magnitude <input type="checkbox"/> First Under Voltage Trip Time <input type="checkbox"/> Over Frequency Magnitude <input type="checkbox"/> Over Frequency Trip Time <input type="checkbox"/> Response to Utility Recovery
Test description:	At the balance condition of 66% load, the fundamental magnitude of grid current in L2 (1 <sup>st</sup> harmonic current) was 71.1 mA, less than 1% of the rated current 213 mA. See screenshot of power analyzer for detail.		



Used equipment No.:	See equipment list for details	Sample No.:	N/A
Finished date:	_____	Tested by:	_____
Review date:	_____	Reviewed by:	_____





# Compliance Evaluation Report



REPORT No.: CSSC/BOS/012

ISSUED DATE: August 20, 2021

APPENDIX C. TÜV Rheinland's Report No: CN21ZH49 001. (Cont.)

Test Data / Test Plan		TÜVRheinland®	
TÜV Rheinland (Shanghai) Co., Ltd.		Document No.: TD-0189	
Protection and Control requirements for PEA Interface of Inverter based Generation Systems 2016.08		Report No:	CN21ZH49 001
Order No. :	244313300	Product:	Grid-Connected PV Inverter
Client Name :	SolaX Power Network Technology (Zhejiang)Co.,Ltd	Model designation:	X3-Hybrid G4

## Attachment : 1

Picture No.:	37	Clause:	7
Test:	<input checked="" type="checkbox"/> Islanding Protection <input type="checkbox"/> Secondary Over Voltage Magnitude <input type="checkbox"/> Secondary Over Voltage Trip Time <input type="checkbox"/> Secondary Under Voltage Magnitude <input type="checkbox"/> Secondary Under Voltage Trip Time <input type="checkbox"/> Under Frequency Magnitude <input type="checkbox"/> Under Frequency Trip Time <input type="checkbox"/> First Over Voltage Magnitude <input type="checkbox"/> First Over Voltage Trip Time <input type="checkbox"/> First Under Voltage Magnitude <input type="checkbox"/> First Under Voltage Trip Time <input type="checkbox"/> Over Frequency Magnitude <input type="checkbox"/> Over Frequency Trip Time <input type="checkbox"/> Response to Utility Recovery		
Test description:	At the balance condition of 66% load, the fundamental magnitude of grid current in L3 (1 <sup>st</sup> harmonic current) was 57.3mA, less than 1% of the rated current 213 mA. See screenshot of power analyzer for detail.		



Used equipment No.: See equipment list for details

Sample No.: N/A

Finished date:

Tested by:

Review date:

Reviewed by:







# Compliance Evaluation Report



REPORT No.: CSSC/BOS/012

ISSUED DATE: August 20, 2021

APPENDIX C. TÜV Rheinland's Report No: CN21ZH49 001. (Cont.)

<b>Test Data / Test Plan</b>			
TÜV Rheinland (Shanghai) Co., Ltd.		Document No.: TD-0189	
Protection and Control requirements for PEA Interface of Inverter based Generation Systems 2016.08		Report No:	CN21ZH49 001
Order No. :	244313300	Product:	Grid-Connected PV Inverter
Client Name :	SolaX Power Network Technology (Zhejiang)Co.,Ltd	Model designation:	X3-Hybrid G4

## Attachment : 1

Picture No.:	38	Clause:	7
Test:	<input checked="" type="checkbox"/> Islanding Protection <input type="checkbox"/> Secondary Over Voltage Magnitude <input type="checkbox"/> Secondary Over Voltage Trip Time <input type="checkbox"/> Secondary Under Voltage Magnitude <input type="checkbox"/> Secondary Under Voltage Trip Time <input type="checkbox"/> Under Frequency Magnitude <input type="checkbox"/> Under Frequency Trip Time	<input type="checkbox"/> First Over Voltage Magnitude <input type="checkbox"/> First Over Voltage Trip Time <input type="checkbox"/> First Under Voltage Magnitude <input type="checkbox"/> First Under Voltage Trip Time <input type="checkbox"/> Over Frequency Magnitude <input type="checkbox"/> Over Frequency Trip Time <input type="checkbox"/> Response to Utility Recovery	
Test description:	66% load, PR: 0%, QL: +1%, the trip time of protection was 374 ms. CH1/2/7 were the output currents of the inverter; CH8/9/10 were the currents flowing through to the grid, also regarded as the trip signal while the grid was switched off. The wave No. was orded from top to end.		



Used equipment No.: See equipment list for details      Sample No.: N/A  
 Finished date: \_\_\_\_\_      Tested by: \_\_\_\_\_  
 Review date: \_\_\_\_\_      Reviewed by: \_\_\_\_\_





# Compliance Evaluation Report



REPORT No.: CSSC/BOS/012

ISSUED DATE: August 20, 2021

APPENDIX C. TÜV Rheinland's Report No: CN21ZH49 001. (Cont.)

<b>Test Data / Test Plan</b>			
TÜV Rheinland (Shanghai) Co., Ltd.		Document No.: TD-0189	
Protection and Control requirements for PEA Interface of Inverter based Generation Systems 2016.08		Report No:	CN21ZH49 001
Order No. :	244313300	Product:	Grid-Connected PV Inverter
Client Name :	SolaX Power Network Technology (Zhejiang)Co.,Ltd	Model designation:	X3-Hybrid G4

## Attachment : 1

Picture No.:	39	Clause:	7
Test:	<input checked="" type="checkbox"/> Islanding Protection <input type="checkbox"/> Secondary Over Voltage Magnitude <input type="checkbox"/> Secondary Over Voltage Trip Time <input type="checkbox"/> Secondary Under Voltage Magnitude <input type="checkbox"/> Secondary Under Voltage Trip Time <input type="checkbox"/> Under Frequency Magnitude <input type="checkbox"/> Under Frequency Trip Time		<input type="checkbox"/> First Over Voltage Magnitude <input type="checkbox"/> First Over Voltage Trip Time <input type="checkbox"/> First Under Voltage Magnitude <input type="checkbox"/> First Under Voltage Trip Time <input type="checkbox"/> Over Frequency Magnitude <input type="checkbox"/> Over Frequency Trip Time <input type="checkbox"/> Response to Utility Recovery
Test description:	66% load, PR: 0%, QL: +2%, the trip time of protection was 225 ms. CH1/2/7 were the output currents of the inverter; CH8/9/10 were the currents flowing through to the grid, also regarded as the trip signal while the grid was switched off. The wave No. was ordered from top to end.		



Used equipment No.: See equipment list for details      Sample No.: N/A  
 Finished date: \_\_\_\_\_      Tested by: \_\_\_\_\_  
 Review date: \_\_\_\_\_      Reviewed by: \_\_\_\_\_





# Compliance Evaluation Report



REPORT No.: CSSC/BOS/012

ISSUED DATE: August 20, 2021

APPENDIX C. TÜV Rheinland's Report No: CN21ZH49 001. (Cont.)

<b>Test Data / Test Plan</b>			
TÜV Rheinland (Shanghai) Co., Ltd.		Document No.: TD-0189	
Protection and Control requirements for PEA Interface of Inverter based Generation Systems 2016.08		Report No:	CN21ZH49 001
Order No. :	244313300	Product:	Grid-Connected PV Inverter
Client Name :	SolaX Power Network Technology (Zhejiang)Co.,Ltd	Model designation:	X3-Hybrid G4

## Attachment : 1

Picture No.:	40	Clause:	7
Test:	<input checked="" type="checkbox"/> Islanding Protection <input type="checkbox"/> Secondary Over Voltage Magnitude <input type="checkbox"/> Secondary Over Voltage Trip Time <input type="checkbox"/> Secondary Under Voltage Magnitude <input type="checkbox"/> Secondary Under Voltage Trip Time <input type="checkbox"/> Under Frequency Magnitude <input type="checkbox"/> Under Frequency Trip Time		<input type="checkbox"/> First Over Voltage Magnitude <input type="checkbox"/> First Over Voltage Trip Time <input type="checkbox"/> First Under Voltage Magnitude <input type="checkbox"/> First Under Voltage Trip Time <input type="checkbox"/> Over Frequency Magnitude <input type="checkbox"/> Over Frequency Trip Time <input type="checkbox"/> Response to Utility Recovery
Test description:	66% load, PR: 0%, QL: +3%, the trip time of protection was 148 ms. CH1/2/7 were the output currents of the inverter; CH8/9/10 were the currents flowing through to the grid, also regarded as the trip signal while the grid was switched off. The wave No. was orded from top to end.		



Used equipment No.: See equipment list for details      Sample No.: N/A

Finished date: \_\_\_\_\_      Tested by: \_\_\_\_\_

Review date: \_\_\_\_\_      Reviewed by: \_\_\_\_\_





# Compliance Evaluation Report



REPORT No.: CSSC/BOS/012

ISSUED DATE: August 20, 2021

APPENDIX C. TÜV Rheinland's Report No: CN21ZH49 001. (Cont.)

<b>Test Data / Test Plan</b>			
TÜV Rheinland (Shanghai) Co., Ltd.		Document No.: TD-0189	
Protection and Control requirements for PEA Interface of Inverter based Generation Systems 2016.08		Report No:	CN21ZH49 001
Order No. :	244313300	Product:	Grid-Connected PV Inverter
Client Name :	SolaX Power Network Technology (Zhejiang)Co.,Ltd	Model designation:	X3-Hybrid G4

## Attachment : 1

Picture No.:	41	Clause:	7
Test:	<input checked="" type="checkbox"/> Islanding Protection <input type="checkbox"/> Secondary Over Voltage Magnitude <input type="checkbox"/> Secondary Over Voltage Trip Time <input type="checkbox"/> Secondary Under Voltage Magnitude <input type="checkbox"/> Secondary Under Voltage Trip Time <input type="checkbox"/> Under Frequency Magnitude <input type="checkbox"/> Under Frequency Trip Time	<input type="checkbox"/> First Over Voltage Magnitude <input type="checkbox"/> First Over Voltage Trip Time <input type="checkbox"/> First Under Voltage Magnitude <input type="checkbox"/> First Under Voltage Trip Time <input type="checkbox"/> Over Frequency Magnitude <input type="checkbox"/> Over Frequency Trip Time <input type="checkbox"/> Response to Utility Recovery	
Test description:	66% load, PR: 0%, QL: +4%, the trip time of protection was 125 ms. CH1/2/7 were the output currents of the inverter; CH8/9/10 were the currents flowing through to the grid, also regarded as the trip signal while the grid was switched off. The wave No. was ordered from top to end.		

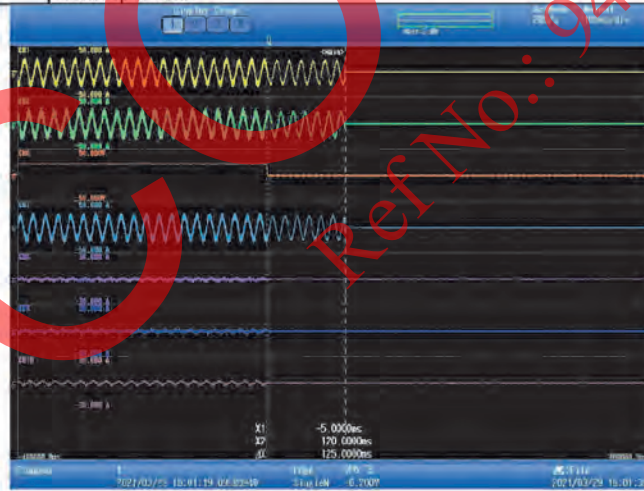

Used equipment No.: See equipment list for details      Sample No.: N/A

Finished date: \_\_\_\_\_      Tested by: \_\_\_\_\_

Review date: \_\_\_\_\_      Reviewed by: \_\_\_\_\_





# Compliance Evaluation Report



REPORT No.: CSSC/BOS/012

ISSUED DATE: August 20, 2021

APPENDIX C. TÜV Rheinland's Report No: CN21ZH49 001. (Cont.)

<b>Test Data / Test Plan</b>			
TÜV Rheinland (Shanghai) Co., Ltd.		Document No.: TD-0189	
Protection and Control requirements for PEA Interface of Inverter based Generation Systems 2016.08		Report No:	CN21ZH49 001
Order No. :	244313300	Product:	Grid-Connected PV Inverter
Client Name :	SolaX Power Network Technology (Zhejiang)Co.,Ltd	Model designation:	X3-Hybrid G4

## Attachment : 1

Picture No.:	42	Clause:	7
Test:	<input checked="" type="checkbox"/> Islanding Protection <input type="checkbox"/> Secondary Over Voltage Magnitude <input type="checkbox"/> Secondary Over Voltage Trip Time <input type="checkbox"/> Secondary Under Voltage Magnitude <input type="checkbox"/> Secondary Under Voltage Trip Time <input type="checkbox"/> Under Frequency Magnitude <input type="checkbox"/> Under Frequency Trip Time	<input type="checkbox"/> First Over Voltage Magnitude <input type="checkbox"/> First Over Voltage Trip Time <input type="checkbox"/> First Under Voltage Magnitude <input type="checkbox"/> First Under Voltage Trip Time <input type="checkbox"/> Over Frequency Magnitude <input type="checkbox"/> Over Frequency Trip Time <input type="checkbox"/> Response to Utility Recovery	
Test description:	66% load, PR: 0%, QL: +5%, the trip time of protection was 121 ms. CH1/2/7 were the output currents of the inverter; CH8/9/10 were the currents flowing through to the grid, also regarded as the trip signal while the grid was switched off. The wave No. was ordered from top to end.		

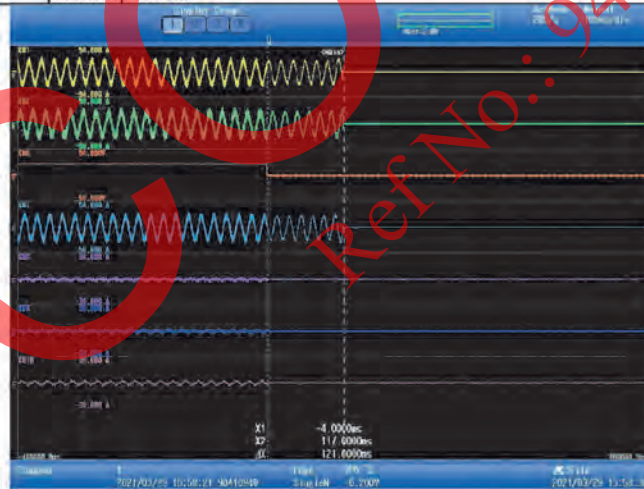

Used equipment No.: See equipment list for details      Sample No.: N/A  
 Finished date: \_\_\_\_\_      Tested by: \_\_\_\_\_  
 Review date: \_\_\_\_\_      Reviewed by: \_\_\_\_\_





# Compliance Evaluation Report



REPORT No.: CSSC/BOS/012

ISSUED DATE: August 20, 2021

APPENDIX C. TÜV Rheinland's Report No: CN21ZH49 001. (Cont.)

<b>Test Data / Test Plan</b>			
TÜV Rheinland (Shanghai) Co., Ltd.		Document No.: TD-0189	
Protection and Control requirements for PEA Interface of Inverter based Generation Systems 2016.08		Report No:	CN21ZH49 001
Order No. :	244313300	Product:	Grid-Connected PV Inverter
Client Name :	SolaX Power Network Technology (Zhejiang)Co.,Ltd	Model designation:	X3-Hybrid G4

## Attachment : 1

Picture No.:	43	Clause:	7
Test:	<input checked="" type="checkbox"/> Islanding Protection <input type="checkbox"/> Secondary Over Voltage Magnitude <input type="checkbox"/> Secondary Over Voltage Trip Time <input type="checkbox"/> Secondary Under Voltage Magnitude <input type="checkbox"/> Secondary Under Voltage Trip Time <input type="checkbox"/> Under Frequency Magnitude <input type="checkbox"/> Under Frequency Trip Time	<input type="checkbox"/> First Over Voltage Magnitude <input type="checkbox"/> First Over Voltage Trip Time <input type="checkbox"/> First Under Voltage Magnitude <input type="checkbox"/> First Under Voltage Trip Time <input type="checkbox"/> Over Frequency Magnitude <input type="checkbox"/> Over Frequency Trip Time <input type="checkbox"/> Response to Utility Recovery	
Test description:	33% load, PR: 0%, QL: -5%, the trip time of protection was 105 ms. CH1/2/7 were the output currents of the inverter; CH8/9/10 were the currents flowing through to the grid, also regarded as the trip signal while the grid was switched off. The wave No. was ordered from top to end.		

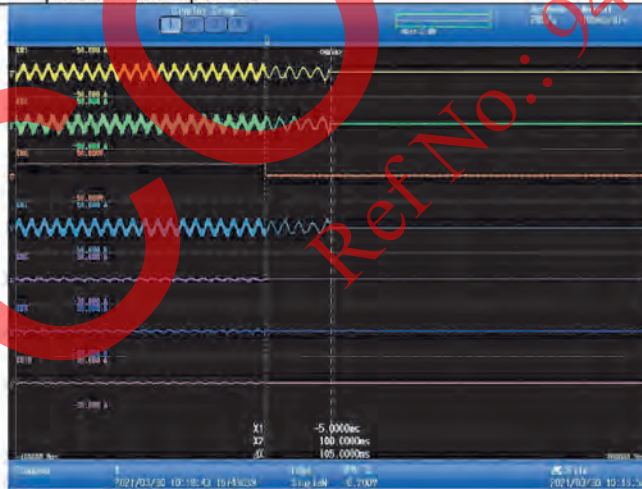

Used equipment No.: See equipment list for details      Sample No.: N/A

Finished date: \_\_\_\_\_      Tested by: \_\_\_\_\_

Review date: \_\_\_\_\_      Reviewed by: \_\_\_\_\_





# Compliance Evaluation Report



REPORT No.: CSSC/BOS/012

ISSUED DATE: August 20, 2021

APPENDIX C. TÜV Rheinland's Report No: CN21ZH49 001. (Cont.)

<b>Test Data / Test Plan</b>			
TÜV Rheinland (Shanghai) Co., Ltd.		Document No.: TD-0189	
Protection and Control requirements for PEA Interface of Inverter based Generation Systems 2016.08		Report No:	CN21ZH49 001
Order No. :	244313300	Product:	Grid-Connected PV Inverter
Client Name :	SolaX Power Network Technology (Zhejiang)Co.,Ltd	Model designation:	X3-Hybrid G4

## Attachment : 1

Picture No.:	44	Clause:	7
Test:	<input checked="" type="checkbox"/> Islanding Protection <input type="checkbox"/> Secondary Over Voltage Magnitude <input type="checkbox"/> Secondary Over Voltage Trip Time <input type="checkbox"/> Secondary Under Voltage Magnitude <input type="checkbox"/> Secondary Under Voltage Trip Time <input type="checkbox"/> Under Frequency Magnitude <input type="checkbox"/> Under Frequency Trip Time	<input type="checkbox"/> First Over Voltage Magnitude <input type="checkbox"/> First Over Voltage Trip Time <input type="checkbox"/> First Under Voltage Magnitude <input type="checkbox"/> First Under Voltage Trip Time <input type="checkbox"/> Over Frequency Magnitude <input type="checkbox"/> Over Frequency Trip Time <input type="checkbox"/> Response to Utility Recovery	
Test description:	33% load, PR: 0%, QL: -4%, the trip time of protection was 115 ms. CH1/2/7 were the output currents of the inverter; CH8/9/10 were the currents flowing through to the grid, also regarded as the trip signal while the grid was switched off. The wave No. was ordered from top to end.		



Used equipment No.: See equipment list for details      Sample No.: N/A

Finished date: \_\_\_\_\_      Tested by: \_\_\_\_\_

Review date: \_\_\_\_\_      Reviewed by: \_\_\_\_\_





# Compliance Evaluation Report



REPORT No.: CSSC/BOS/012

ISSUED DATE: August 20, 2021

APPENDIX C. TÜV Rheinland's Report No: CN21ZH49 001. (Cont.)

<b>Test Data / Test Plan</b>			
TÜV Rheinland (Shanghai) Co., Ltd.		Document No.: TD-0189	
Protection and Control requirements for PEA Interface of Inverter based Generation Systems 2016.08		Report No:	CN21ZH49 001
Order No. :	244313300	Product:	Grid-Connected PV Inverter
Client Name :	SolaX Power Network Technology (Zhejiang)Co.,Ltd	Model designation:	X3-Hybrid G4

## Attachment : 1

Picture No.:	45	Clause:	7
Test:	<input checked="" type="checkbox"/> Islanding Protection <input type="checkbox"/> Secondary Over Voltage Magnitude <input type="checkbox"/> Secondary Over Voltage Trip Time <input type="checkbox"/> Secondary Under Voltage Magnitude <input type="checkbox"/> Secondary Under Voltage Trip Time <input type="checkbox"/> Under Frequency Magnitude <input type="checkbox"/> Under Frequency Trip Time	<input type="checkbox"/> First Over Voltage Magnitude <input type="checkbox"/> First Over Voltage Trip Time <input type="checkbox"/> First Under Voltage Magnitude <input type="checkbox"/> First Under Voltage Trip Time <input type="checkbox"/> Over Frequency Magnitude <input type="checkbox"/> Over Frequency Trip Time <input type="checkbox"/> Response to Utility Recovery	
Test description:	33% load, PR: 0%, QL: -3%, the trip time of protection was 125 ms. CH1/2/7 were the output currents of the inverter; CH8/9/10 were the currents flowing through to the grid, also regarded as the trip signal while the grid was switched off. The wave No. was ordered from top to end.		

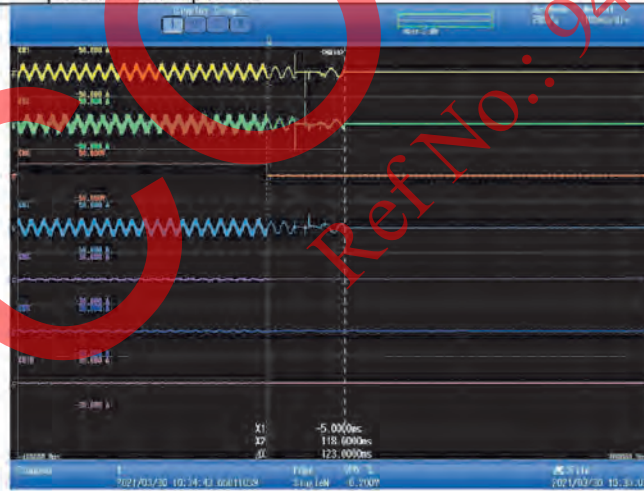

Used equipment No.: See equipment list for details      Sample No.: N/A  
 Finished date: \_\_\_\_\_      Tested by: \_\_\_\_\_  
 Review date: \_\_\_\_\_      Reviewed by: \_\_\_\_\_





# Compliance Evaluation Report



REPORT No.: CSSC/BOS/012

ISSUED DATE: August 20, 2021

APPENDIX C. TÜV Rheinland's Report No: CN21ZH49 001. (Cont.)

<b>Test Data / Test Plan</b>			
TÜV Rheinland (Shanghai) Co., Ltd.		Document No.: TD-0189	
Protection and Control requirements for PEA Interface of Inverter based Generation Systems 2016.08		Report No:	CN21ZH49 001
Order No. :	244313300	Product:	Grid-Connected PV Inverter
Client Name :	SolaX Power Network Technology (Zhejiang)Co.,Ltd	Model designation:	X3-Hybrid G4

## Attachment : 1

Picture No.:	46	Clause:	7
Test:	<input checked="" type="checkbox"/> Islanding Protection <input type="checkbox"/> Secondary Over Voltage Magnitude <input type="checkbox"/> Secondary Over Voltage Trip Time <input type="checkbox"/> Secondary Under Voltage Magnitude <input type="checkbox"/> Secondary Under Voltage Trip Time <input type="checkbox"/> Under Frequency Magnitude <input type="checkbox"/> Under Frequency Trip Time	<input type="checkbox"/> First Over Voltage Magnitude <input type="checkbox"/> First Over Voltage Trip Time <input type="checkbox"/> First Under Voltage Magnitude <input type="checkbox"/> First Under Voltage Trip Time <input type="checkbox"/> Over Frequency Magnitude <input type="checkbox"/> Over Frequency Trip Time <input type="checkbox"/> Response to Utility Recovery	
Test description:	33% load, PR: 0%, QL: -2%, the trip time of protection was 203 ms. CH1/2/7 were the output currents of the inverter; CH8/9/10 were the currents flowing through to the grid, also regarded as the trip signal while the grid was switched off. The wave No. was ordered from top to end.		



Used equipment No.: See equipment list for details      Sample No.: N/A  
 Finished date: \_\_\_\_\_      Tested by: \_\_\_\_\_  
 Review date: \_\_\_\_\_      Reviewed by: \_\_\_\_\_





# Compliance Evaluation Report



REPORT No.: CSSC/BOS/012

ISSUED DATE: August 20, 2021

APPENDIX C. TÜV Rheinland's Report No: CN21ZH49 001. (Cont.)

<b>Test Data / Test Plan</b>			
TÜV Rheinland (Shanghai) Co., Ltd.		Document No.: TD-0189	
Protection and Control requirements for PEA Interface of Inverter based Generation Systems 2016.08		Report No:	CN21ZH49 001
Order No. :	244313300	Product:	Grid-Connected PV Inverter
Client Name :	SolaX Power Network Technology (Zhejiang)Co.,Ltd	Model designation:	X3-Hybrid G4

## Attachment : 1

Picture No.:	47	Clause:	7
Test:	<input checked="" type="checkbox"/> Islanding Protection <input type="checkbox"/> Secondary Over Voltage Magnitude <input type="checkbox"/> Secondary Over Voltage Trip Time <input type="checkbox"/> Secondary Under Voltage Magnitude <input type="checkbox"/> Secondary Under Voltage Trip Time <input type="checkbox"/> Under Frequency Magnitude <input type="checkbox"/> Under Frequency Trip Time		<input type="checkbox"/> First Over Voltage Magnitude <input type="checkbox"/> First Over Voltage Trip Time <input type="checkbox"/> First Under Voltage Magnitude <input type="checkbox"/> First Under Voltage Trip Time <input type="checkbox"/> Over Frequency Magnitude <input type="checkbox"/> Over Frequency Trip Time <input type="checkbox"/> Response to Utility Recovery
Test description:	33% load, PR: 0%, QL: -1%, the trip time of protection was 212 ms. CH1/2/7 were the output currents of the inverter; CH8/9/10 were the currents flowing through to the grid, also regarded as the trip signal while the grid was switched off. The wave No. was ordered from top to end.		



Used equipment No.: See equipment list for details      Sample No.: N/A

Finished date: \_\_\_\_\_      Tested by: \_\_\_\_\_

Review date: \_\_\_\_\_      Reviewed by: \_\_\_\_\_





# Compliance Evaluation Report



REPORT No.: CSSC/BOS/012

ISSUED DATE: August 20, 2021

APPENDIX C. TÜV Rheinland's Report No: CN21ZH49 001. (Cont.)

<b>Test Data / Test Plan</b>			
TÜV Rheinland (Shanghai) Co., Ltd.		Document No.: TD-0189	
Protection and Control requirements for PEA Interface of Inverter based Generation Systems 2016.08		Report No:	CN21ZH49 001
Order No. :	244313300	Product:	Grid-Connected PV Inverter
Client Name :	SolaX Power Network Technology (Zhejiang)Co.,Ltd	Model designation:	X3-Hybrid G4

## Attachment : 1

Picture No.:	48	Clause:	7
Test:	<input checked="" type="checkbox"/> Islanding Protection <input type="checkbox"/> Secondary Over Voltage Magnitude <input type="checkbox"/> Secondary Over Voltage Trip Time <input type="checkbox"/> Secondary Under Voltage Magnitude <input type="checkbox"/> Secondary Under Voltage Trip Time <input type="checkbox"/> Under Frequency Magnitude <input type="checkbox"/> Under Frequency Trip Time	<input type="checkbox"/> First Over Voltage Magnitude <input type="checkbox"/> First Over Voltage Trip Time <input type="checkbox"/> First Under Voltage Magnitude <input type="checkbox"/> First Under Voltage Trip Time <input type="checkbox"/> Over Frequency Magnitude <input type="checkbox"/> Over Frequency Trip Time <input type="checkbox"/> Response to Utility Recovery	
Test description:	33% load, PR: 0%, QL: 0%, the trip time of protection was 249 ms. CH1/2/7 were the output currents of the inverter; CH8/9/10 were the currents flowing through to the grid, also regarded as the trip signal while the grid was switched off. The wave No. was ordered from top to end.		



Used equipment No.: See equipment list for details      Sample No.: N/A

Finished date: \_\_\_\_\_      Tested by: \_\_\_\_\_

Review date: \_\_\_\_\_      Reviewed by: \_\_\_\_\_





# Compliance Evaluation Report



REPORT No.: CSSC/BOS/012

ISSUED DATE: August 20, 2021

APPENDIX C. TÜV Rheinland's Report No: CN21ZH49 001. (Cont.)

<b>Test Data / Test Plan</b>			
TÜV Rheinland (Shanghai) Co., Ltd.		Document No.: TD-0189	
Protection and Control requirements for PEA Interface of Inverter based Generation Systems 2016.08		Report No:	CN21ZH49 001
Order No. :	244313300	Product:	Grid-Connected PV Inverter
Client Name :	SolaX Power Network Technology (Zhejiang)Co.,Ltd	Model designation:	X3-Hybrid G4

## Attachment : 1

Picture No.:	49	Clause:	7
Test:	<input checked="" type="checkbox"/> Islanding Protection <input type="checkbox"/> Secondary Over Voltage Magnitude <input type="checkbox"/> Secondary Over Voltage Trip Time <input type="checkbox"/> Secondary Under Voltage Magnitude <input type="checkbox"/> Secondary Under Voltage Trip Time <input type="checkbox"/> Under Frequency Magnitude <input type="checkbox"/> Under Frequency Trip Time <input type="checkbox"/> First Over Voltage Magnitude <input type="checkbox"/> First Over Voltage Trip Time <input type="checkbox"/> First Under Voltage Magnitude <input type="checkbox"/> First Under Voltage Trip Time <input type="checkbox"/> Over Frequency Magnitude <input type="checkbox"/> Over Frequency Trip Time <input type="checkbox"/> Response to Utility Recovery		
Test description:	At the balance condition of 33% load, the fundamental magnitude of grid current in L1 was 37.1 mA (1 <sup>st</sup> harmonic current), less than 1% of the rated current 213 mA. See the screenshot of power analyzer for detail.		



Used equipment No.: See equipment list for details

Sample No.: N/A

Finished date:

Tested by:

Review date:

Reviewed by:





# Compliance Evaluation Report



REPORT No.: CSSC/BOS/012

ISSUED DATE: August 20, 2021

APPENDIX C. TÜV Rheinland's Report No: CN21ZH49 001. (Cont.)

<b>Test Data / Test Plan</b>			
TÜV Rheinland (Shanghai) Co., Ltd.		Document No.: TD-0189	
Protection and Control requirements for PEA Interface of Inverter based Generation Systems 2016.08		Report No:	CN21ZH49 001
Order No. :	244313300	Product:	Grid-Connected PV Inverter
Client Name :	SolaX Power Network Technology (Zhejiang)Co.,Ltd	Model designation:	X3-Hybrid G4

## Attachment : 1

Picture No.:	50	Clause:	7
Test:	<input checked="" type="checkbox"/> Islanding Protection <input type="checkbox"/> Secondary Over Voltage Magnitude <input type="checkbox"/> Secondary Over Voltage Trip Time <input type="checkbox"/> Secondary Under Voltage Magnitude <input type="checkbox"/> Secondary Under Voltage Trip Time <input type="checkbox"/> Under Frequency Magnitude <input type="checkbox"/> Under Frequency Trip Time		
Test description:	<input type="checkbox"/> First Over Voltage Magnitude <input type="checkbox"/> First Over Voltage Trip Time <input type="checkbox"/> First Under Voltage Magnitude <input type="checkbox"/> First Under Voltage Trip Time <input type="checkbox"/> Over Frequency Magnitude <input type="checkbox"/> Over Frequency Trip Time <input type="checkbox"/> Response to Utility Recovery		
At the balance condition of 33% load, the fundamental magnitude of grid current in L2 was 50.8 mA (1 <sup>st</sup> harmonic current), less than 1% of the rated current 213 mA. See the screenshot of power analyzer for detail.			

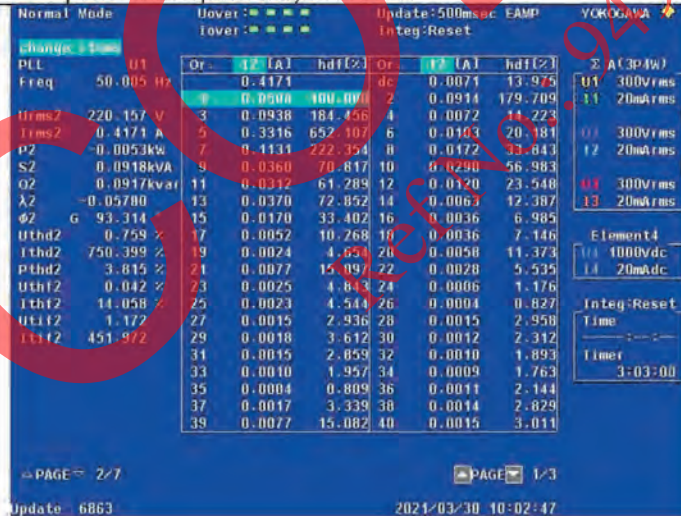

Used equipment No.: See equipment list for details      Sample No.: N/A

Finished date: \_\_\_\_\_      Tested by: \_\_\_\_\_

Review date: \_\_\_\_\_      Reviewed by: \_\_\_\_\_





# Compliance Evaluation Report



REPORT No.: CSSC/BOS/012

ISSUED DATE: August 20, 2021

APPENDIX C. TÜV Rheinland's Report No: CN21ZH49 001. (Cont.)

<b>Test Data / Test Plan</b>			
TÜV Rheinland (Shanghai) Co., Ltd.		Document No.: TD-0189	
Protection and Control requirements for PEA Interface of Inverter based Generation Systems 2016.08		Report No:	CN21ZH49 001
Order No. :	244313300	Product:	Grid-Connected PV Inverter
Client Name :	SolaX Power Network Technology (Zhejiang)Co.,Ltd	Model designation:	X3-Hybrid G4

## Attachment : 1

Picture No.:	51	Clause:	7
Test:	<input checked="" type="checkbox"/> Islanding Protection <input type="checkbox"/> Secondary Over Voltage Magnitude <input type="checkbox"/> Secondary Over Voltage Trip Time <input type="checkbox"/> Secondary Under Voltage Magnitude <input type="checkbox"/> Secondary Under Voltage Trip Time <input type="checkbox"/> Under Frequency Magnitude <input type="checkbox"/> Under Frequency Trip Time		<input type="checkbox"/> First Over Voltage Magnitude <input type="checkbox"/> First Over Voltage Trip Time <input type="checkbox"/> First Under Voltage Magnitude <input type="checkbox"/> First Under Voltage Trip Time <input type="checkbox"/> Over Frequency Magnitude <input type="checkbox"/> Over Frequency Trip Time <input type="checkbox"/> Response to Utility Recovery
Test description:	At the balance condition of 33% load, the fundamental magnitude of grid current in L3 was 51.2 mA (1 <sup>st</sup> harmonic current), less than 1% of the rated current 213 mA. See the screenshot of power analyzer for detail.		

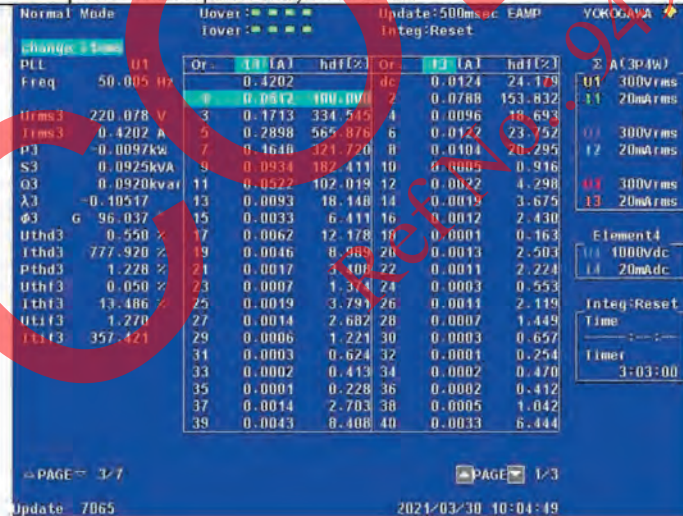

Used equipment No.: See equipment list for details

Sample No.: N/A

Finished date:

Tested by:

Review date:

Reviewed by:





# Compliance Evaluation Report



REPORT No.: CSSC/BOS/012

ISSUED DATE: August 20, 2021

APPENDIX C. TÜV Rheinland's Report No: CN21ZH49 001. (Cont.)

<b>Test Data / Test Plan</b>			
TÜV Rheinland (Shanghai) Co., Ltd.		Document No.: TD-0189	
Protection and Control requirements for PEA Interface of Inverter based Generation Systems 2016.08		Report No:	CN21ZH49 001
Order No. :	244313300	Product:	Grid-Connected PV Inverter
Client Name :	SolaX Power Network Technology (Zhejiang)Co.,Ltd	Model designation:	X3-Hybrid G4

## Attachment : 1

Picture No.:	52	Clause:	7
Test:	<input checked="" type="checkbox"/> Islanding Protection <input type="checkbox"/> Secondary Over Voltage Magnitude <input type="checkbox"/> Secondary Over Voltage Trip Time <input type="checkbox"/> Secondary Under Voltage Magnitude <input type="checkbox"/> Secondary Under Voltage Trip Time <input type="checkbox"/> Under Frequency Magnitude <input type="checkbox"/> Under Frequency Trip Time	<input type="checkbox"/> First Over Voltage Magnitude <input type="checkbox"/> First Over Voltage Trip Time <input type="checkbox"/> First Under Voltage Magnitude <input type="checkbox"/> First Under Voltage Trip Time <input type="checkbox"/> Over Frequency Magnitude <input type="checkbox"/> Over Frequency Trip Time <input type="checkbox"/> Response to Utility Recovery	
Test description:	33% load, PR: 0%, QL: +1%, the trip time of protection was 230ms. CH1/2/7 were the output currents of the inverter; CH8/9/10 were the currents flowing through to the grid, also regarded as the trip signal while the grid was switched off. The wave No. was ordered from top to end.		



Used equipment No.: See equipment list for details      Sample No.: N/A

Finished date: \_\_\_\_\_      Tested by: \_\_\_\_\_

Review date: \_\_\_\_\_      Reviewed by: \_\_\_\_\_





# Compliance Evaluation Report



REPORT No.: CSSC/BOS/012

ISSUED DATE: August 20, 2021

APPENDIX C. TÜV Rheinland's Report No: CN21ZH49 001. (Cont.)

Test Data / Test Plan		TÜVRheinland®	
TÜV Rheinland (Shanghai) Co., Ltd.		Document No.: TD-0189	
Protection and Control requirements for PEA Interface of Inverter based Generation Systems 2016.08		Report No:	CN21ZH49 001
Order No. :	244313300	Product:	Grid-Connected PV Inverter
Client Name :	SolaX Power Network Technology (Zhejiang)Co.,Ltd	Model designation:	X3-Hybrid G4

## Attachment : 1

Picture No.:	53	Clause:	7
Test:	<input checked="" type="checkbox"/> Islanding Protection <input type="checkbox"/> Secondary Over Voltage Magnitude <input type="checkbox"/> Secondary Over Voltage Trip Time <input type="checkbox"/> Secondary Under Voltage Magnitude <input type="checkbox"/> Secondary Under Voltage Trip Time <input type="checkbox"/> Under Frequency Magnitude <input type="checkbox"/> Under Frequency Trip Time		<input type="checkbox"/> First Over Voltage Magnitude <input type="checkbox"/> First Over Voltage Trip Time <input type="checkbox"/> First Under Voltage Magnitude <input type="checkbox"/> First Under Voltage Trip Time <input type="checkbox"/> Over Frequency Magnitude <input type="checkbox"/> Over Frequency Trip Time <input type="checkbox"/> Response to Utility Recovery
Test description:	33% load, PR: 0%, QL: +2%, the trip time of protection was 203 ms. CH1/2/7 were the output currents of the inverter; CH8/9/10 were the currents flowing through to the grid, also regarded as the trip signal while the grid was switched off. The wave No. was ordered from top to end.		



Used equipment No.: See equipment list for details

Sample No.: N/A

Finished date:

Tested by:

Review date:

Reviewed by:





# Compliance Evaluation Report



REPORT No.: CSSC/BOS/012

ISSUED DATE: August 20, 2021

APPENDIX C. TÜV Rheinland's Report No: CN21ZH49 001. (Cont.)

<b>Test Data / Test Plan</b>		TÜVRheinland®	
TÜV Rheinland (Shanghai) Co., Ltd.		Document No.: TD-0189	
Protection and Control requirements for PEA Interface of Inverter based Generation Systems 2016.08		Report No:	CN21ZH49 001
Order No. :	244313300	Product:	Grid-Connected PV Inverter
Client Name :	SolaX Power Network Technology (Zhejiang)Co.,Ltd	Model designation:	X3-Hybrid G4

## Attachment : 1

Picture No.:	54	Clause:	7
Test:	<input checked="" type="checkbox"/> Islanding Protection <input type="checkbox"/> Secondary Over Voltage Magnitude <input type="checkbox"/> Secondary Over Voltage Trip Time <input type="checkbox"/> Secondary Under Voltage Magnitude <input type="checkbox"/> Secondary Under Voltage Trip Time <input type="checkbox"/> Under Frequency Magnitude <input type="checkbox"/> Under Frequency Trip Time <input type="checkbox"/> First Over Voltage Magnitude <input type="checkbox"/> First Over Voltage Trip Time <input type="checkbox"/> First Under Voltage Magnitude <input type="checkbox"/> First Under Voltage Trip Time <input type="checkbox"/> Over Frequency Magnitude <input type="checkbox"/> Over Frequency Trip Time <input type="checkbox"/> Response to Utility Recovery		
Test description:	33% load, PR: 0%, QL: +3%, the trip time of protection was 195 ms. CH1/2/7 were the output currents of the inverter, CH8/9/10 were the currents flowing through to the grid, also regarded as the trip signal while the grid was switched off. The wave No. was ordered from top to end.		



Used equipment No.: See equipment list for details      Sample No.: N/A  
 Finished date: \_\_\_\_\_      Tested by: \_\_\_\_\_  
 Review date: \_\_\_\_\_      Reviewed by: \_\_\_\_\_



# Compliance Evaluation Report



REPORT No.: CSSC/BOS/012

ISSUED DATE: August 20, 2021

APPENDIX C. TÜV Rheinland's Report No: CN21ZH49 001. (Cont.)

<b>Test Data / Test Plan</b>			
TÜV Rheinland (Shanghai) Co., Ltd.		Document No.: TD-0189	
Protection and Control requirements for PEA Interface of Inverter based Generation Systems 2016.08		Report No:	CN21ZH49 001
Order No. :	244313300	Product:	Grid-Connected PV Inverter
Client Name :	SolaX Power Network Technology (Zhejiang)Co.,Ltd	Model designation:	X3-Hybrid G4

## Attachment : 1

Picture No.:	55	Clause:	7
Test:	<input checked="" type="checkbox"/> Islanding Protection <input type="checkbox"/> Secondary Over Voltage Magnitude <input type="checkbox"/> Secondary Over Voltage Trip Time <input type="checkbox"/> Secondary Under Voltage Magnitude <input type="checkbox"/> Secondary Under Voltage Trip Time <input type="checkbox"/> Under Frequency Magnitude <input type="checkbox"/> Under Frequency Trip Time		<input type="checkbox"/> First Over Voltage Magnitude <input type="checkbox"/> First Over Voltage Trip Time <input type="checkbox"/> First Under Voltage Magnitude <input type="checkbox"/> First Under Voltage Trip Time <input type="checkbox"/> Over Frequency Magnitude <input type="checkbox"/> Over Frequency Trip Time <input type="checkbox"/> Response to Utility Recovery
Test description:	33% load, PR: 0%, QL: +4%, the trip time of protection was 119 ms, CH1/2/7 were the output currents of the inverter, CH8/9/10 were the currents flowing through to the grid, also regarded as the trip signal while the grid was switched off. The wave No. was ordered from top to end.		



Used equipment No.:	See equipment list for details	Sample No.:	N/A
Finished date:	_____	Tested by:	_____
Review date:	_____	Reviewed by:	_____



# Compliance Evaluation Report



REPORT No.: CSSC/BOS/012

ISSUED DATE: August 20, 2021

APPENDIX C. TÜV Rheinland's Report No: CN21ZH49 001. (Cont.)

<b>Test Data / Test Plan</b>			
TÜV Rheinland (Shanghai) Co., Ltd.		Document No.: TD-0189	
Protection and Control requirements for PEA Interface of Inverter based Generation Systems 2016.08		Report No:	CN21ZH49 001
Order No. :	244313300	Product:	Grid-Connected PV Inverter
Client Name :	SolaX Power Network Technology (Zhejiang)Co.,Ltd	Model designation:	X3-Hybrid G4

## Attachment : 1

Picture No.:	56	Clause:	7
Test:	<input checked="" type="checkbox"/> Islanding Protection <input type="checkbox"/> Secondary Over Voltage Magnitude <input type="checkbox"/> Secondary Over Voltage Trip Time <input type="checkbox"/> Secondary Under Voltage Magnitude <input type="checkbox"/> Secondary Under Voltage Trip Time <input type="checkbox"/> Under Frequency Magnitude <input type="checkbox"/> Under Frequency Trip Time		<input type="checkbox"/> First Over Voltage Magnitude <input type="checkbox"/> First Over Voltage Trip Time <input type="checkbox"/> First Under Voltage Magnitude <input type="checkbox"/> First Under Voltage Trip Time <input type="checkbox"/> Over Frequency Magnitude <input type="checkbox"/> Over Frequency Trip Time <input type="checkbox"/> Response to Utility Recovery
Test description:	33% load, PR: 0%, QL: +5%, the trip time of protection was 111ms. CH1/2/7 were the output currents of the inverter; CH8/9/10 were the currents flowing through to the grid, also regarded as the trip signal while the grid was switched off. The wave No. was ordered from top to end.		



Used equipment No.:	See equipment list for details	Sample No.:	N/A
Finished date:	_____	Tested by:	_____
Review date:	_____	Reviewed by:	_____



# Compliance Evaluation Report



REPORT No.: CSSC/BOS/012

ISSUED DATE: August 20, 2021

APPENDIX C. TÜV Rheinland's Report No: CN21ZH49 001. (Cont.)

<b>Test Data / Test Plan</b>			
TÜV Rheinland (Shanghai) Co., Ltd.		Document No.: TD-0189	
Protection and Control requirements for PEA Interface of Inverter based Generation Systems 2016.08		Report No:	CN21ZH49 001
Order No. :	244313300	Product:	Grid-Connected PV Inverter
Client Name :	SolaX Power Network Technology (Zhejiang)Co.,Ltd	Model designation:	X3-Hybrid G4

## Attachment : 1

Picture No.:	57	Clause:	8
Test:	<input type="checkbox"/> Islanding Protection <input type="checkbox"/> Secondary Over Voltage Magnitude <input type="checkbox"/> Secondary Over Voltage Trip Time <input type="checkbox"/> Secondary Under Voltage Magnitude <input type="checkbox"/> Secondary Under Voltage Trip Time <input type="checkbox"/> Under Frequency Magnitude <input type="checkbox"/> Under Frequency Trip Time <input type="checkbox"/> First Over Voltage Magnitude <input type="checkbox"/> First Over Voltage Trip Time <input checked="" type="checkbox"/> First Under Voltage Magnitude <input checked="" type="checkbox"/> First Under Voltage Trip Time <input type="checkbox"/> Over Frequency Magnitude <input type="checkbox"/> Over Frequency Trip Time <input checked="" type="checkbox"/> Response to Utility Recovery		
Test description:	Inverter won't reconnect to grid while the grid voltage remained above 242V after the over voltage protection was tripped; Wave No. 3/4/5 were the grid voltages; Wave No.8/9/10 were the output currents of inverter; Wave No. 7 was the trip signal while the grid voltage changed. The wave No. was ordered from top to end.		

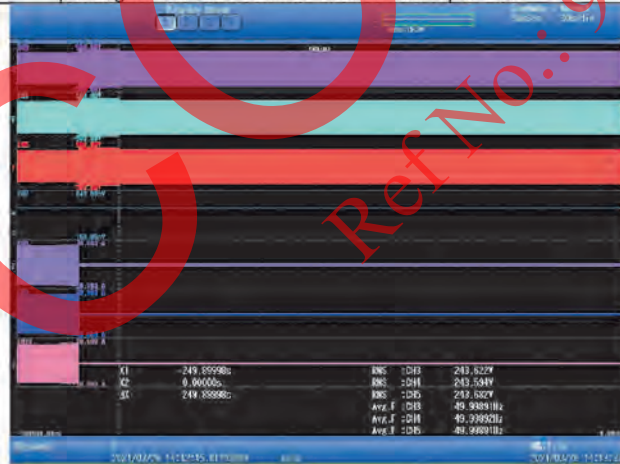

Used equipment No.: See equipment list for details      Sample No.: N/A

Finished date: \_\_\_\_\_      Tested by: \_\_\_\_\_

Review date: \_\_\_\_\_      Reviewed by: \_\_\_\_\_





# Compliance Evaluation Report



REPORT No.: CSSC/BOS/012

ISSUED DATE: August 20, 2021

APPENDIX C. TÜV Rheinland's Report No: CN21ZH49 001. (Cont.)

<b>Test Data / Test Plan</b>			
TÜV Rheinland (Shanghai) Co., Ltd.		Document No.: TD-0189	
Protection and Control requirements for PEA Interface of Inverter based Generation Systems 2016.08		Report No:	CN21ZH49 001
Order No. :	244313300	Product:	Grid-Connected PV Inverter
Client Name :	SolaX Power Network Technology (Zhejiang)Co.,Ltd	Model designation:	X3-Hybrid G4

## Attachment : 1

Picture No.:	58	Clause:	8
Test:	<input type="checkbox"/> Islanding Protection <input type="checkbox"/> Secondary Over Voltage Magnitude <input type="checkbox"/> Secondary Over Voltage Trip Time <input type="checkbox"/> Secondary Under Voltage Magnitude <input type="checkbox"/> Secondary Under Voltage Trip Time <input type="checkbox"/> Under Frequency Magnitude <input type="checkbox"/> Under Frequency Trip Time <input type="checkbox"/> First Over Voltage Magnitude <input type="checkbox"/> First Over Voltage Trip Time <input type="checkbox"/> First Under Voltage Magnitude <input type="checkbox"/> First Under Voltage Trip Time <input type="checkbox"/> Over Frequency Magnitude <input type="checkbox"/> Over Frequency Trip Time <input checked="" type="checkbox"/> Response to Utility Recovery		
Test description:	Inverter reconnect to grid with 125.1s delay while grid voltage remained below 242V after the over voltage protection was tripped; Wave No. 3/4/5 were the grid voltages; Wave No.8/9/10 were the output currents of inverter; Wave No. 7 was the trip signal while the grid voltage changed. The wave No. was ordered from top to end.		

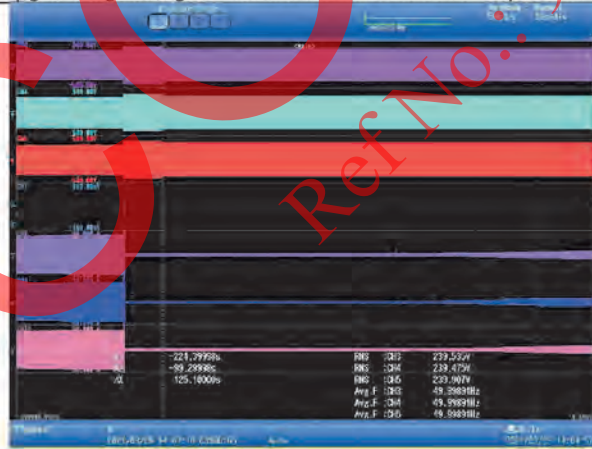

Used equipment No.:	See equipment list for details	Sample No.:	N/A
Finished date:	_____	Tested by:	_____
Review date:	_____	Reviewed by:	_____





# Compliance Evaluation Report



REPORT No.: CSSC/BOS/012

ISSUED DATE: August 20, 2021

APPENDIX C. TÜV Rheinland's Report No: CN21ZH49 001. (Cont.)

<b>Test Data / Test Plan</b>			
TÜV Rheinland (Shanghai) Co., Ltd.		Document No.: TD-0189	
Protection and Control requirements for PEA Interface of Inverter based Generation Systems 2016.08		Report No:	CN21ZH49 001
Order No. :	244313300	Product:	Grid-Connected PV Inverter
Client Name :	SolaX Power Network Technology (Zhejiang)Co.,Ltd	Model designation:	X3-Hybrid G4

## Attachment : 1

Picture No.:	59	Clause:	8
Test:	<input type="checkbox"/> Islanding Protection <input type="checkbox"/> Secondary Over Voltage Magnitude <input type="checkbox"/> Secondary Over Voltage Trip Time <input type="checkbox"/> Secondary Under Voltage Magnitude <input type="checkbox"/> Secondary Under Voltage Trip Time <input type="checkbox"/> Under Frequency Magnitude <input type="checkbox"/> Under Frequency Trip Time <input type="checkbox"/> First Over Voltage Magnitude <input type="checkbox"/> First Over Voltage Trip Time <input type="checkbox"/> First Under Voltage Magnitude <input type="checkbox"/> First Under Voltage Trip Time <input type="checkbox"/> Over Frequency Magnitude <input type="checkbox"/> Over Frequency Trip Time <input checked="" type="checkbox"/> Response to Utility Recovery		
Test description:	Inverter won't reconnect to grid while the grid voltage remained under 198V after the under voltage protection was tripped; Wave No. 3/4/5 were the grid voltages; Wave No. 8/9/10 were the output currents of inverter; Wave No. 7 was the trip signal while the grid voltage changed. The wave No. was ordered from top to end..		

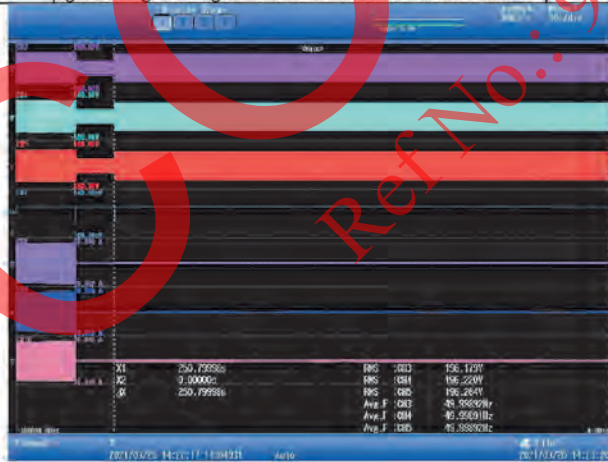

Used equipment No.:	See equipment list for details	Sample No.:	N/A
Finished date:	_____	Tested by:	_____
Review date:	_____	Reviewed by:	_____





# Compliance Evaluation Report



REPORT No.: CSSC/BOS/012

ISSUED DATE: August 20, 2021

APPENDIX C. TÜV Rheinland's Report No: CN21ZH49 001. (Cont.)

<b>Test Data / Test Plan</b>			
TÜV Rheinland (Shanghai) Co., Ltd.		Document No.: TD-0189	
Protection and Control requirements for PEA Interface of Inverter based Generation Systems 2016.08		Report No:	CN21ZH49 001
Order No. :	244313300	Product:	Grid-Connected PV Inverter
Client Name :	SolaX Power Network Technology (Zhejiang)Co.,Ltd	Model designation:	X3-Hybrid G4

## Attachment : 1

Picture No.:	60	Clause:	8
Test:	<input type="checkbox"/> Islanding Protection <input type="checkbox"/> Secondary Over Voltage Magnitude <input type="checkbox"/> Secondary Over Voltage Trip Time <input type="checkbox"/> Secondary Under Voltage Magnitude <input type="checkbox"/> Secondary Under Voltage Trip Time <input type="checkbox"/> Under Frequency Magnitude <input type="checkbox"/> Under Frequency Trip Time	<input type="checkbox"/> First Over Voltage Magnitude <input type="checkbox"/> First Over Voltage Trip Time <input type="checkbox"/> First Under Voltage Magnitude <input type="checkbox"/> First Under Voltage Trip Time <input type="checkbox"/> Over Frequency Magnitude <input type="checkbox"/> Over Frequency Trip Time <input checked="" type="checkbox"/> Response to Utility Recovery	
Test description:	Inverter reconnect to grid with 121.5s delay while grid voltage remained above 198V after the under voltage protection was tripped; Wave No. 3/4/5 were the grid voltages; Wave No.8/9/10 were the output currents of inverter; Wave No. 7 was the trip signal while the grid voltage changed. The wave No. was ordered from top to end..		



Used equipment No.:	See equipment list for details	Sample No.:	N/A
Finished date:	_____	Tested by:	_____
Review date:	_____	Reviewed by:	_____





# Compliance Evaluation Report



REPORT No.: CSSC/BOS/012

ISSUED DATE: August 20, 2021

APPENDIX C. TÜV Rheinland's Report No: CN21ZH49 001. (Cont.)

<b>Test Data / Test Plan</b>			
TÜV Rheinland (Shanghai) Co., Ltd.		Document No.: TD-0189	
Protection and Control requirements for PEA Interface of Inverter based Generation Systems 2016.08		Report No:	CN21ZH49 001
Order No. :	244313300	Product:	Grid-Connected PV Inverter
Client Name :	SolaX Power Network Technology (Zhejiang)Co.,Ltd	Model designation:	X3-Hybrid G4

## Attachment : 1

Picture No.:	61	Clause:	8
Test:	<input type="checkbox"/> Islanding Protection <input type="checkbox"/> Secondary Over Voltage Magnitude <input type="checkbox"/> Secondary Over Voltage Trip Time <input type="checkbox"/> Secondary Under Voltage Magnitude <input type="checkbox"/> Secondary Under Voltage Trip Time <input type="checkbox"/> Under Frequency Magnitude <input type="checkbox"/> Under Frequency Trip Time <input type="checkbox"/> First Over Voltage Magnitude <input type="checkbox"/> First Over Voltage Trip Time <input type="checkbox"/> First Under Voltage Magnitude <input type="checkbox"/> First Under Voltage Trip Time <input type="checkbox"/> Over Frequency Magnitude <input type="checkbox"/> Over Frequency Trip Time <input checked="" type="checkbox"/> Response to Utility Recovery		
Test description:	Inverter won't reconnect to grid while the grid voltage frequency remained above 52Hz after the over frequency protection was tripped; Wave No. 3/4/5 were the grid voltages; Wave No. 8/9/10 were the output currents of inverter; Wave No. 7 was the trip signal while the grid voltage changed. The wave No. was ordered from top to end.		

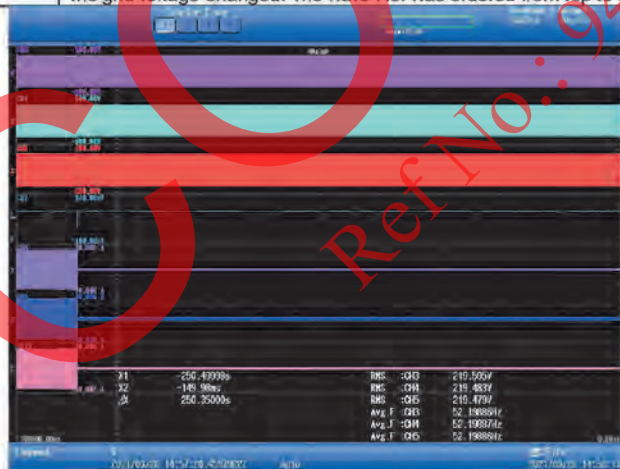

Used equipment No.: See equipment list for details      Sample No.: N/A

Finished date: \_\_\_\_\_      Tested by: \_\_\_\_\_

Review date: \_\_\_\_\_      Reviewed by: \_\_\_\_\_







# Compliance Evaluation Report



REPORT No.: CSSC/BOS/012

ISSUED DATE: August 20, 2021

APPENDIX C. TÜV Rheinland's Report No: CN21ZH49 001. (Cont.)

<b>Test Data / Test Plan</b>			
TÜV Rheinland (Shanghai) Co., Ltd.		Document No.: TD-0189	
Protection and Control requirements for PEA Interface of Inverter based Generation Systems 2016.08		Report No:	CN21ZH49 001
Order No. :	244313300	Product:	Grid-Connected PV Inverter
Client Name :	SolaX Power Network Technology (Zhejiang)Co.,Ltd	Model designation:	X3-Hybrid G4

## Attachment : 1

Picture No.:	62	Clause:	8
Test:	<input type="checkbox"/> Islanding Protection <input type="checkbox"/> Secondary Over Voltage Magnitude <input type="checkbox"/> Secondary Over Voltage Trip Time <input type="checkbox"/> Secondary Under Voltage Magnitude <input type="checkbox"/> Secondary Under Voltage Trip Time <input type="checkbox"/> Under Frequency Magnitude <input type="checkbox"/> Under Frequency Trip Time	<input type="checkbox"/> First Over Voltage Magnitude <input type="checkbox"/> First Over Voltage Trip Time <input type="checkbox"/> First Under Voltage Magnitude <input type="checkbox"/> First Under Voltage Trip Time <input type="checkbox"/> Over Frequency Magnitude <input type="checkbox"/> Over Frequency Trip Time <input checked="" type="checkbox"/> Response to Utility Recovery	
Test description:	Inverter reconnect to grid with 123.3s delay while grid voltage frequency remained below 52Hz after the over frequency protection was tripped Wave No. 3/4/5 were the grid voltages; Wave No.8/9/10 were the output currents of inverter; Wave No. 7 was the trip signal while the grid voltage changed. The wave No. was ordered from top to end.		

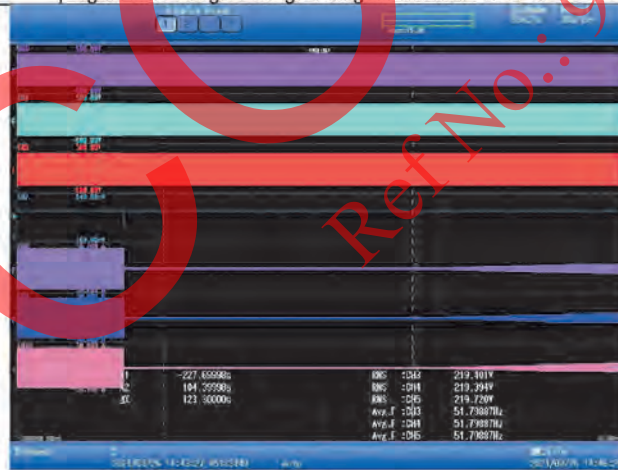

Used equipment No.: See equipment list for details Sample No.: N/A

Finished date: \_\_\_\_\_ Tested by: \_\_\_\_\_

Review date: \_\_\_\_\_ Reviewed by: \_\_\_\_\_





# Compliance Evaluation Report



REPORT No.: CSSC/BOS/012

ISSUED DATE: August 20, 2021

APPENDIX C. TÜV Rheinland's Report No: CN21ZH49 001. (Cont.)

<b>Test Data / Test Plan</b>			
TÜV Rheinland (Shanghai) Co., Ltd.		Document No.: TD-0189	
Protection and Control requirements for PEA Interface of Inverter based Generation Systems 2016.08		Report No:	CN21ZH49 001
Order No. :	244313300	Product:	Grid-Connected PV Inverter
Client Name :	SolaX Power Network Technology (Zhejiang)Co.,Ltd	Model designation:	X3-Hybrid G4

## Attachment : 1

Picture No.:	63	Clause:	8
Test:	<input type="checkbox"/> Islanding Protection <input type="checkbox"/> Secondary Over Voltage Magnitude <input type="checkbox"/> Secondary Over Voltage Trip Time <input type="checkbox"/> Secondary Under Voltage Magnitude <input type="checkbox"/> Secondary Under Voltage Trip Time <input type="checkbox"/> Under Frequency Magnitude <input type="checkbox"/> Under Frequency Trip Time	<input type="checkbox"/> First Over Voltage Magnitude <input type="checkbox"/> First Over Voltage Trip Time <input type="checkbox"/> First Under Voltage Magnitude <input type="checkbox"/> First Under Voltage Trip Time <input type="checkbox"/> Over Frequency Magnitude <input type="checkbox"/> Over Frequency Trip Time <input checked="" type="checkbox"/> Response to Utility Recovery	
Test description:	Inverter won't reconnect to grid while the grid voltage frequency remained below 47Hz after the under frequency protection was tripped; Wave No. 3/4/5 were the grid voltages; Wave No 8/9/10 were the output currents of inverter; Wave No. 7 was the trip signal while the grid voltage changed. The wave No. was ordered from top to end.		

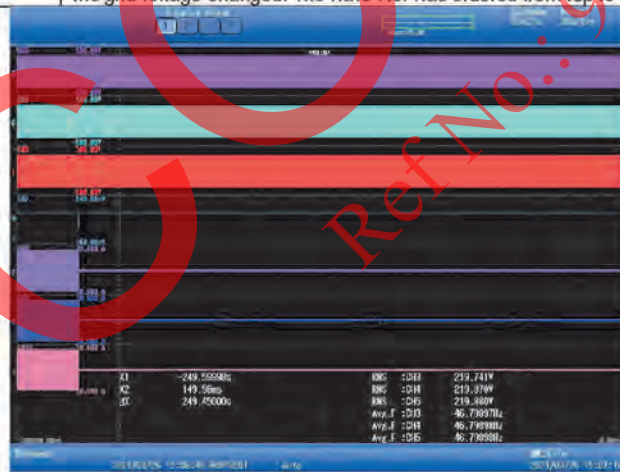

Used equipment No.: See equipment list for details      Sample No.: N/A

Finished date: \_\_\_\_\_      Tested by: \_\_\_\_\_

Review date: \_\_\_\_\_      Reviewed by: \_\_\_\_\_





# Compliance Evaluation Report



REPORT No.: CSSC/BOS/012

ISSUED DATE: August 20, 2021

APPENDIX C. TÜV Rheinland's Report No: CN21ZH49 001. (Cont.)

<b>Test Data / Test Plan</b>			
TÜV Rheinland (Shanghai) Co., Ltd.		Document No.: TD-0189	
Protection and Control requirements for PEA Interface of Inverter based Generation Systems 2016.08		Report No:	CN21ZH49 001
Order No. :	244313300	Product:	Grid-Connected PV Inverter
Client Name :	SolaX Power Network Technology (Zhejiang)Co.,Ltd	Model designation:	X3-Hybrid G4

## Attachment : 1

Picture No.:	64	Clause:	8
Test:	<input type="checkbox"/> Islanding Protection <input type="checkbox"/> Secondary Over Voltage Magnitude <input type="checkbox"/> Secondary Over Voltage Trip Time <input type="checkbox"/> Secondary Under Voltage Magnitude <input type="checkbox"/> Secondary Under Voltage Trip Time <input type="checkbox"/> Under Frequency Magnitude <input type="checkbox"/> Under Frequency Trip Time	<input type="checkbox"/> First Over Voltage Magnitude <input type="checkbox"/> First Over Voltage Trip Time <input type="checkbox"/> First Under Voltage Magnitude <input type="checkbox"/> First Under Voltage Trip Time <input type="checkbox"/> Over Frequency Magnitude <input type="checkbox"/> Over Frequency Trip Time <input checked="" type="checkbox"/> Response to Utility Recovery	
Test description:	Inverter reconnect to grid with 121.5s delay while grid voltage frequency remained over 47Hz after the over frequency protection was tripped; Wave No. 3/4/5 were the grid voltages; Wave No. 8/9/10 were the output currents of inverter; Wave No. 7 was the trip signal while the grid voltage changed. The wave No. was ordered from top to end.		

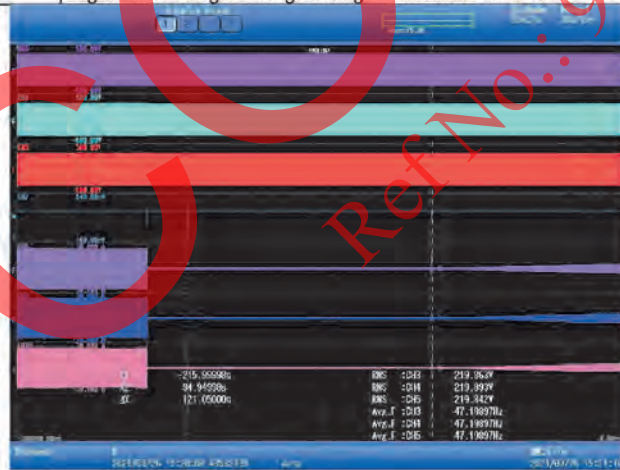

Used equipment No.: See equipment list for details

Sample No.: N/A

Finished date:

Tested by:

Review date:

Reviewed by:





# Compliance Evaluation Report



REPORT No.: CSSC/BOS/012

ISSUED DATE: August 20, 2021

APPENDIX C. TÜV Rheinland's Report No: CN21ZH49 001. (Cont.)

<b>Test Data / Test Plan</b>			
TÜV Rheinland (Shanghai) Co., Ltd.		Document No.: TD-0189	
Protection and Control requirements for PEA Interface of Inverter based Generation Systems 2016.08		Report No:	CN21ZH49 001
Order No. :	244313300	Product:	Grid-Connected PV Inverter
Client Name :	SolaX Power Network Technology (Zhejiang)Co.,Ltd	Model designation:	X3-Hybrid G4

## Attachment : 1

Picture No.:	65	Clause:	8
Test:	<input type="checkbox"/> Islanding Protection <input type="checkbox"/> Secondary Over Voltage Magnitude <input type="checkbox"/> Secondary Over Voltage Trip Time <input type="checkbox"/> Secondary Under Voltage Magnitude <input type="checkbox"/> Secondary Under Voltage Trip Time <input type="checkbox"/> Under Frequency Magnitude <input type="checkbox"/> Under Frequency Trip Time		<input type="checkbox"/> First Over Voltage Magnitude <input type="checkbox"/> First Over Voltage Trip Time <input type="checkbox"/> First Under Voltage Magnitude <input type="checkbox"/> First Under Voltage Trip Time <input type="checkbox"/> Over Frequency Magnitude <input type="checkbox"/> Over Frequency Trip Time <input checked="" type="checkbox"/> Response to Utility Recovery
Test description:	Inverter reconnect to grid with 122.6 s delay while grid voltage remained below 242V. The grid voltage jumped over 242V again during the countdown period after the over voltage protection was tripped; Wave No. 3/4/5 were the grid voltages; Wave No. 8/9/10 were the output currents of inverter; Wave No. 7 was the trip signal while the grid voltage changed. The wave No. was ordered from top to end.		

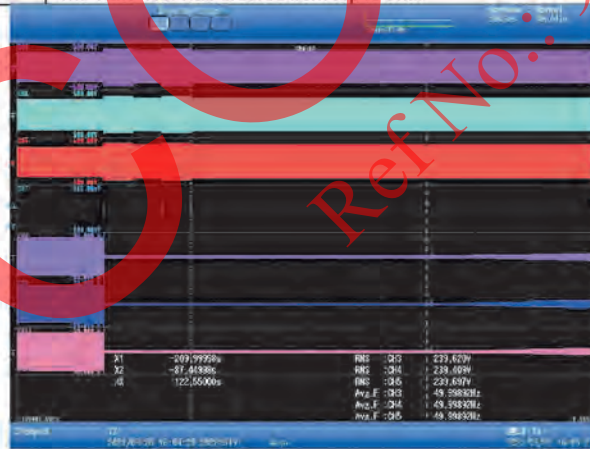

Used equipment No.:	See equipment list for details	Sample No.:	N/A
Finished date:	_____	Tested by:	_____
Review date:	_____	Reviewed by:	_____





# Compliance Evaluation Report



REPORT No.: CSSC/BOS/012

ISSUED DATE: August 20, 2021

APPENDIX C. TÜV Rheinland's Report No: CN21ZH49 001. (Cont.)

<b>Test Data / Test Plan</b>			
TÜV Rheinland (Shanghai) Co., Ltd.		Document No.: TD-0189	
Protection and Control requirements for PEA Interface of Inverter based Generation Systems 2016.08		Report No:	CN21ZH49 001
Order No. :	244313300	Product:	Grid-Connected PV Inverter
Client Name :	SolaX Power Network Technology (Zhejiang)Co.,Ltd	Model designation:	X3-Hybrid G4

## Attachment : 1

Picture No.:	66	Clause:	8
Test:	<input type="checkbox"/> Islanding Protection <input type="checkbox"/> Secondary Over Voltage Magnitude <input type="checkbox"/> Secondary Over Voltage Trip Time <input type="checkbox"/> Secondary Under Voltage Magnitude <input type="checkbox"/> Secondary Under Voltage Trip Time <input type="checkbox"/> Under Frequency Magnitude <input type="checkbox"/> Under Frequency Trip Time	<input type="checkbox"/> First Over Voltage Magnitude <input type="checkbox"/> First Over Voltage Trip Time <input type="checkbox"/> First Under Voltage Magnitude <input type="checkbox"/> First Under Voltage Trip Time <input type="checkbox"/> Over Frequency Magnitude <input type="checkbox"/> Over Frequency Trip Time <input checked="" type="checkbox"/> Response to Utility Recovery	
Test description:	Inverter reconnect to grid with 123.9 s delay while grid voltage remained above 198V. The grid voltage jump below 198V again during the countdown period after the under voltage protection was tripped; Wave No. 3/4/5 were the grid voltages; Wave No.8/9/10 were the output currents of inverter; Wave No. 7 was the trip signal while the grid voltage changed. The wave No. was ordered from top to end.		

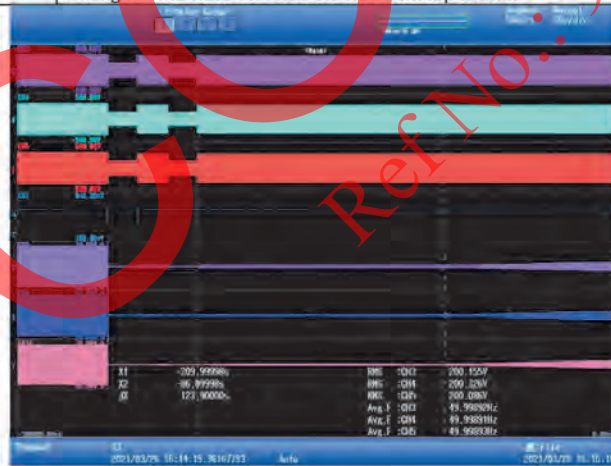

Used equipment No.: See equipment list for details      Sample No.: N/A  
 Finished date: \_\_\_\_\_      Tested by: \_\_\_\_\_  
 Review date: \_\_\_\_\_      Reviewed by: \_\_\_\_\_





# Compliance Evaluation Report



REPORT No.: CSSC/BOS/012

ISSUED DATE: August 20, 2021

APPENDIX C. TÜV Rheinland's Report No: CN21ZH49 001. (Cont.)

<b>Test Data / Test Plan</b>			
TÜV Rheinland (Shanghai) Co., Ltd.		Document No.: TD-0189	
Protection and Control requirements for PEA Interface of Inverter based Generation Systems 2016.08		Report No:	CN21ZH49 001
Order No. :	244313300	Product:	Grid-Connected PV Inverter
Client Name :	SolaX Power Network Technology (Zhejiang)Co.,Ltd	Model designation:	X3-Hybrid G4

## Attachment : 1

Picture No.:	67	Clause:	8
Test:	<input type="checkbox"/> Islanding Protection <input type="checkbox"/> Secondary Over Voltage Magnitude <input type="checkbox"/> Secondary Over Voltage Trip Time <input type="checkbox"/> Secondary Under Voltage Magnitude <input type="checkbox"/> Secondary Under Voltage Trip Time <input type="checkbox"/> Under Frequency Magnitude <input type="checkbox"/> Under Frequency Trip Time <input type="checkbox"/> First Over Voltage Magnitude <input type="checkbox"/> First Over Voltage Trip Time <input type="checkbox"/> First Under Voltage Magnitude <input type="checkbox"/> First Under Voltage Trip Time <input type="checkbox"/> Over Frequency Magnitude <input type="checkbox"/> Over Frequency Trip Time <input checked="" type="checkbox"/> Response to Utility Recovery		
Test description:	Inverter reconnect to grid with 149.1s delay while grid voltage frequency remained below 52Hz. The grid voltage frequency jumped over 52Hz again during the countdown period after the under frequency protection was tripped; Wave No. 3/4/5 were the grid voltages; Wave No. 8/9/10 were the output currents of inverter; Wave No. 7 was the trip signal while the grid voltage changed. The wave No. was ordered from top to end.		

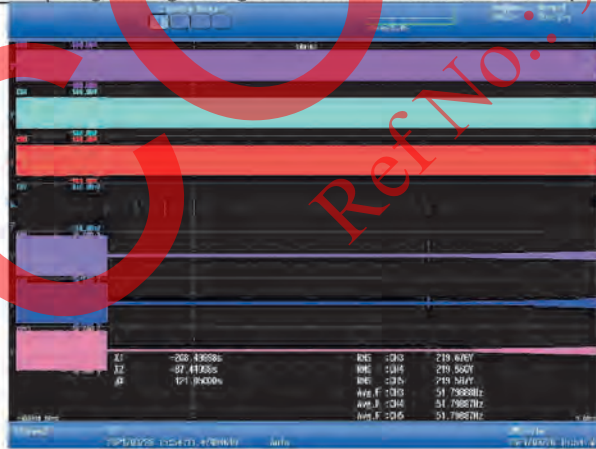

Used equipment No.: See equipment list for details      Sample No.: N/A

Finished date: \_\_\_\_\_      Tested by: \_\_\_\_\_

Review date: \_\_\_\_\_      Reviewed by: \_\_\_\_\_





# Compliance Evaluation Report



REPORT No.: CSSC/BOS/012

ISSUED DATE: August 20, 2021

APPENDIX C. TÜV Rheinland's Report No: CN21ZH49 001. (Cont.)

<b>Test Data / Test Plan</b>			
TÜV Rheinland (Shanghai) Co., Ltd.		Document No.: TD-0189	
Protection and Control requirements for PEA Interface of Inverter based Generation Systems 2016.08		Report No:	CN21ZH49 001
Order No. :	244313300	Product:	Grid-Connected PV Inverter
Client Name :	SolaX Power Network Technology (Zhejiang)Co.,Ltd	Model designation:	X3-Hybrid G4

## Attachment : 1

Picture No.:	68	Clause:	8
Test:	<input type="checkbox"/> Islanding Protection <input type="checkbox"/> Secondary Over Voltage Magnitude <input type="checkbox"/> Secondary Over Voltage Trip Time <input type="checkbox"/> Secondary Under Voltage Magnitude <input type="checkbox"/> Secondary Under Voltage Trip Time <input type="checkbox"/> Under Frequency Magnitude <input type="checkbox"/> Under Frequency Trip Time	<input type="checkbox"/> First Over Voltage Magnitude <input type="checkbox"/> First Over Voltage Trip Time <input type="checkbox"/> First Under Voltage Magnitude <input type="checkbox"/> First Under Voltage Trip Time <input type="checkbox"/> Over Frequency Magnitude <input type="checkbox"/> Over Frequency Trip Time <input checked="" type="checkbox"/> Response to Utility Recovery	
Test description:	Inverter reconnect to grid with 124.7 s delay while grid voltage frequency remained above 47Hz. The grid voltage frequency jumped below 47Hz again during the countdown period after the under frequency protection was tripped; Wave No. 3/4/5 were the grid voltages; Wave No. 8/9/10 were the output currents of inverter; Wave No. 7 was the trip signal while the grid voltage changed. The wave No. was ordered from top to end.		

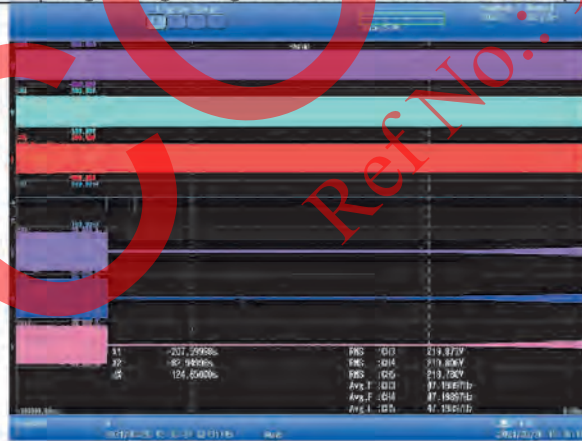

Used equipment No.:	See equipment list for details	Sample No.:	N/A
Finished date:	_____	Tested by:	_____
Review date:	_____	Reviewed by:	_____





# Compliance Evaluation Report



REPORT No.: CSSC/BOS/012

ISSUED DATE: August 20, 2021

APPENDIX C. TÜV Rheinland's Report No: CN21ZH49 001. (Cont.)

<b>Test Data / Test Plan</b>			
TÜV Rheinland (Shanghai) Co., Ltd.		Document No.: TD-0189	
Protection and Control requirements for PEA Interface of Inverter based Generation Systems 2016.08		Report No:	CN21ZH49 001
Order No. :	244313300	Product:	Grid-Connected PV Inverter
Client Name :	SolaX Power Network Technology (Zhejiang)Co.,Ltd	Model designation:	X3-Hybrid G4

## Attachment : 1

Picture No.:	69	Clause:	9
Test:	<input type="checkbox"/> Islanding Protection <input type="checkbox"/> Secondary Over Voltage Magnitude <input type="checkbox"/> Secondary Over Voltage Trip Time <input type="checkbox"/> Secondary Under Voltage Magnitude <input type="checkbox"/> Secondary Under Voltage Trip Time <input type="checkbox"/> Under Frequency Magnitude <input type="checkbox"/> Under Frequency Trip Time	<input checked="" type="checkbox"/> First Over Voltage Magnitude <input checked="" type="checkbox"/> First Over Voltage Trip Time <input type="checkbox"/> First Under Voltage Magnitude <input type="checkbox"/> First Under Voltage Trip Time <input type="checkbox"/> Over Frequency Magnitude <input type="checkbox"/> Over Frequency Trip Time <input type="checkbox"/> Response to Utility Recovery	
Test description:	During the first level over voltage test, the L1 grid voltage was jumped to 268.6V approximately, trip time 127.0 ms. The wave No. 1/2/3 were the grid voltages; The wave No. 5/6/7 were the output currents of inverter; The wave No. 8 was ordered from top to end.		



Used equipment No.: See equipment list for details      Sample No.: N/A

Finished date: \_\_\_\_\_      Tested by: \_\_\_\_\_

Review date: \_\_\_\_\_      Reviewed by: \_\_\_\_\_







# Compliance Evaluation Report



REPORT No.: CSSC/BOS/012

ISSUED DATE: August 20, 2021

APPENDIX C. TÜV Rheinland's Report No: CN21ZH49 001. (Cont.)

Test Data / Test Plan		TÜVRheinland®	
TÜV Rheinland (Shanghai) Co., Ltd.		Document No.: TD-0189	
Protection and Control requirements for PEA Interface of Inverter based Generation Systems 2016.08		Report No:	CN21ZH49 001
Order No. :	244313300	Product:	Grid-Connected PV Inverter
Client Name :	SolaX Power Network Technology (Zhejiang)Co.,Ltd	Model designation:	X3-Hybrid G4

## Attachment : 1

Picture No.:	70	Clause:	9
Test:	<input type="checkbox"/> Islanding Protection <input type="checkbox"/> Secondary Over Voltage Magnitude <input type="checkbox"/> Secondary Over Voltage Trip Time <input type="checkbox"/> Secondary Under Voltage Magnitude <input type="checkbox"/> Secondary Under Voltage Trip Time <input type="checkbox"/> Under Frequency Magnitude <input type="checkbox"/> Under Frequency Trip Time		<input checked="" type="checkbox"/> First Over Voltage Magnitude <input checked="" type="checkbox"/> First Over Voltage Trip Time <input type="checkbox"/> First Under Voltage Magnitude <input type="checkbox"/> First Under Voltage Trip Time <input type="checkbox"/> Over Frequency Magnitude <input type="checkbox"/> Over Frequency Trip Time <input type="checkbox"/> Response to Utility Recovery
Test description:	During the first level over voltage test, the L1 grid voltage was jumped to 268.6V approximately, trip time 127 ms. The wave No. 1/2/3 were the grid voltages; The wave No. 5/6/7 were the output currents of inverter; The wave No. 8 was ordered from top to end.		



Used equipment No.: See equipment list for details      Sample No.: N/A

Finished date: \_\_\_\_\_      Tested by: \_\_\_\_\_

Review date: \_\_\_\_\_      Reviewed by: \_\_\_\_\_





# Compliance Evaluation Report



REPORT No.: CSSC/BOS/012

ISSUED DATE: August 20, 2021

APPENDIX C. TÜV Rheinland's Report No: CN21ZH49 001. (Cont.)

<b>Test Data / Test Plan</b>			
TÜV Rheinland (Shanghai) Co., Ltd.		Document No.: TD-0189	
Protection and Control requirements for PEA Interface of Inverter based Generation Systems 2016.08		Report No:	CN21ZH49 001
Order No. :	244313300	Product:	Grid-Connected PV Inverter
Client Name :	SolaX Power Network Technology (Zhejiang)Co.,Ltd	Model designation:	X3-Hybrid G4

## Attachment : 1

Picture No.:	71	Clause:	9
Test:	<input type="checkbox"/> Islanding Protection <input type="checkbox"/> Secondary Over Voltage Magnitude <input type="checkbox"/> Secondary Over Voltage Trip Time <input type="checkbox"/> Secondary Under Voltage Magnitude <input type="checkbox"/> Secondary Under Voltage Trip Time <input type="checkbox"/> Under Frequency Magnitude <input type="checkbox"/> Under Frequency Trip Time <input checked="" type="checkbox"/> First Over Voltage Magnitude <input checked="" type="checkbox"/> First Over Voltage Trip Time <input type="checkbox"/> First Under Voltage Magnitude <input type="checkbox"/> First Under Voltage Trip Time <input type="checkbox"/> Over Frequency Magnitude <input type="checkbox"/> Over Frequency Trip Time <input type="checkbox"/> Response to Utility Recovery		
Test description:	During the first level over voltage test, the L2 grid voltage was jumped to 268.6V approximately, trip time 138 ms. The wave No. 1/2/3 were the grid voltages; The wave No. 5/6/7 were the output currents of inverter; The wave No. 8 was ordered from top to end.		

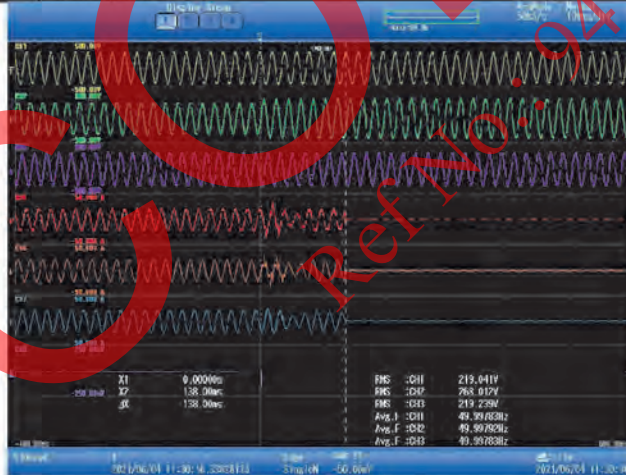

Used equipment No.: See equipment list for details Sample No.: N/A

Finished date: \_\_\_\_\_ Tested by: \_\_\_\_\_

Review date: \_\_\_\_\_ Reviewed by: \_\_\_\_\_





# Compliance Evaluation Report



REPORT No.: CSSC/BOS/012

ISSUED DATE: August 20, 2021

APPENDIX C. TÜV Rheinland's Report No: CN21ZH49 001. (Cont.)

Test Data / Test Plan		TÜVRheinland®	
TÜV Rheinland (Shanghai) Co., Ltd.		Document No.: TD-0189	
Protection and Control requirements for PEA Interface of Inverter based Generation Systems 2016.08		Report No:	CN21ZH49 001
Order No. :	244313300	Product:	Grid-Connected PV Inverter
Client Name :	SolaX Power Network Technology (Zhejiang)Co.,Ltd	Model designation:	X3-Hybrid G4

## Attachment : 1

Picture No.:	72	Clause:	9
Test:	<input type="checkbox"/> Islanding Protection <input type="checkbox"/> Secondary Over Voltage Magnitude <input type="checkbox"/> Secondary Over Voltage Trip Time <input type="checkbox"/> Secondary Under Voltage Magnitude <input type="checkbox"/> Secondary Under Voltage Trip Time <input type="checkbox"/> Under Frequency Magnitude <input type="checkbox"/> Under Frequency Trip Time		<input checked="" type="checkbox"/> First Over Voltage Magnitude <input checked="" type="checkbox"/> First Over Voltage Trip Time <input type="checkbox"/> First Under Voltage Magnitude <input type="checkbox"/> First Under Voltage Trip Time <input type="checkbox"/> Over Frequency Magnitude <input type="checkbox"/> Over Frequency Trip Time <input type="checkbox"/> Response to Utility Recovery
Test description:	During the first level over voltage test, the L2 grid voltage was jumped to 268.6V approximately, trip time 137.5ms. The wave No. 1/2/3 were the grid voltages; The wave No. 5/6/7 were the output currents of inverter. The wave No. 8 was ordered from top to end.		



Used equipment No.: See equipment list for details      Sample No.: N/A

Finished date: \_\_\_\_\_      Tested by: \_\_\_\_\_

Review date: \_\_\_\_\_      Reviewed by: \_\_\_\_\_





# Compliance Evaluation Report



REPORT No.: CSSC/BOS/012

ISSUED DATE: August 20, 2021

APPENDIX C. TÜV Rheinland's Report No: CN21ZH49 001. (Cont.)

Test Data / Test Plan		TÜVRheinland®	
TÜV Rheinland (Shanghai) Co., Ltd.		Document No.: TD-0189	
Protection and Control requirements for PEA Interface of Inverter based Generation Systems 2016.08		Report No:	CN21ZH49 001
Order No. :	244313300	Product:	Grid-Connected PV Inverter
Client Name :	SolaX Power Network Technology (Zhejiang)Co.,Ltd	Model designation:	X3-Hybrid G4

## Attachment : 1

Picture No.:	73	Clause:	9
Test:	<input type="checkbox"/> Islanding Protection <input type="checkbox"/> Secondary Over Voltage Magnitude <input type="checkbox"/> Secondary Over Voltage Trip Time <input type="checkbox"/> Secondary Under Voltage Magnitude <input type="checkbox"/> Secondary Under Voltage Trip Time <input type="checkbox"/> Under Frequency Magnitude <input type="checkbox"/> Under Frequency Trip Time		<input checked="" type="checkbox"/> First Over Voltage Magnitude <input checked="" type="checkbox"/> First Over Voltage Trip Time <input type="checkbox"/> First Under Voltage Magnitude <input type="checkbox"/> First Under Voltage Trip Time <input type="checkbox"/> Over Frequency Magnitude <input type="checkbox"/> Over Frequency Trip Time <input type="checkbox"/> Response to Utility Recovery
Test description:	During the first level over voltage test, the L3 grid voltage was jumped to 268.6V approximately, trip time 131 ms. The wave No. 1/2/3 were the grid voltages; The wave No. 5/6/7 were the output currents of inverter; The wave No. 8 was ordered from top to end.		

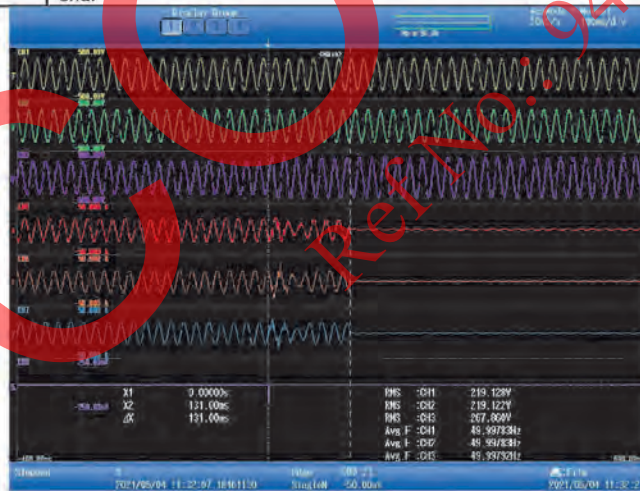

Used equipment No.: See equipment list for details      Sample No.: N/A

Finished date: \_\_\_\_\_      Tested by: \_\_\_\_\_

Review date: \_\_\_\_\_      Reviewed by: \_\_\_\_\_





# Compliance Evaluation Report



REPORT No.: CSSC/BOS/012

ISSUED DATE: August 20, 2021

APPENDIX C. TÜV Rheinland's Report No: CN21ZH49 001. (Cont.)

<b>Test Data / Test Plan</b>			
TÜV Rheinland (Shanghai) Co., Ltd.		Document No.: TD-0189	
Protection and Control requirements for PEA Interface of Inverter based Generation Systems 2016.08		Report No:	CN21ZH49 001
Order No. :	244313300	Product:	Grid-Connected PV Inverter
Client Name :	SolaX Power Network Technology (Zhejiang)Co.,Ltd	Model designation:	X3-Hybrid G4

## Attachment : 1

Picture No.:	74	Clause:	9
Test:	<input type="checkbox"/> Islanding Protection <input type="checkbox"/> Secondary Over Voltage Magnitude <input type="checkbox"/> Secondary Over Voltage Trip Time <input type="checkbox"/> Secondary Under Voltage Magnitude <input type="checkbox"/> Secondary Under Voltage Trip Time <input type="checkbox"/> Under Frequency Magnitude <input type="checkbox"/> Under Frequency Trip Time	<input checked="" type="checkbox"/> First Over Voltage Magnitude <input checked="" type="checkbox"/> First Over Voltage Trip Time <input type="checkbox"/> First Under Voltage Magnitude <input type="checkbox"/> First Under Voltage Trip Time <input type="checkbox"/> Over Frequency Magnitude <input type="checkbox"/> Over Frequency Trip Time <input type="checkbox"/> Response to Utility Recovery	
Test description:	During the first level over voltage test, the L3 grid voltage was jumped to 268.6V approximately, trip time 131 ms. The wave No. 1/2/3 were the grid voltages; The wave No. 5/6/7 were the output currents of inverter; The wave No. 8 was ordered from top to end.		

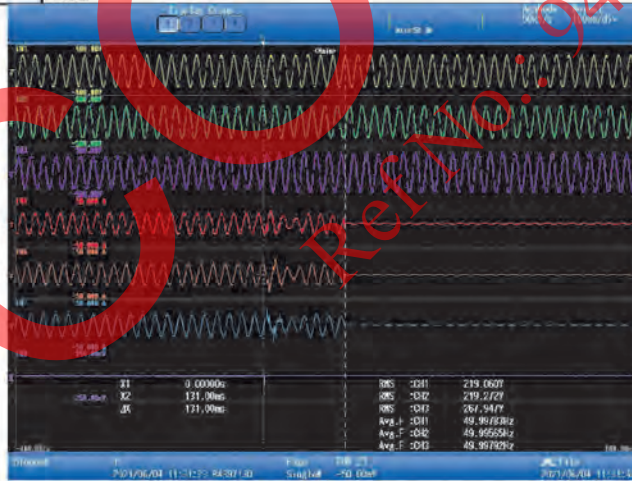

Used equipment No.: See equipment list for details      Sample No.: N/A

Finished date: \_\_\_\_\_      Tested by: \_\_\_\_\_

Review date: \_\_\_\_\_      Reviewed by: \_\_\_\_\_





# Compliance Evaluation Report



REPORT No.: CSSC/BOS/012

ISSUED DATE: August 20, 2021

APPENDIX C. TÜV Rheinland's Report No: CN21ZH49 001. (Cont.)

Test Data / Test Plan		TÜVRheinland®	
TÜV Rheinland (Shanghai) Co., Ltd.		Document No.: TD-0189	
Protection and Control requirements for PEA Interface of Inverter based Generation Systems 2016.08		Report No:	CN21ZH49 001
Order No. :	244313300	Product:	Grid-Connected PV Inverter
Client Name :	SolaX Power Network Technology (Zhejiang)Co.,Ltd	Model designation:	X3-Hybrid G4

## Attachment : 1

Picture No.:	75	Clause:	9
Test:	<input type="checkbox"/> Islanding Protection <input type="checkbox"/> Secondary Over Voltage Magnitude <input type="checkbox"/> Secondary Over Voltage Trip Time <input type="checkbox"/> Secondary Under Voltage Magnitude <input type="checkbox"/> Secondary Under Voltage Trip Time <input type="checkbox"/> Under Frequency Magnitude <input type="checkbox"/> Under Frequency Trip Time		<input checked="" type="checkbox"/> First Over Voltage Magnitude <input checked="" type="checkbox"/> First Over Voltage Trip Time <input type="checkbox"/> First Under Voltage Magnitude <input type="checkbox"/> First Under Voltage Trip Time <input type="checkbox"/> Over Frequency Magnitude <input type="checkbox"/> Over Frequency Trip Time <input type="checkbox"/> Response to Utility Recovery
Test description:	During the first level over voltage test, the L123 grid voltage was jumped to 268.6V approximately, trip time 130.5 ms. The wave No. 1/2/3 were the grid voltages; The wave No. 5/6/7 were the output currents of inverter. The wave No. 8 was ordered from top to end.		



Used equipment No.: See equipment list for details      Sample No.: N/A

Finished date: \_\_\_\_\_      Tested by: \_\_\_\_\_

Review date: \_\_\_\_\_      Reviewed by: \_\_\_\_\_





# Compliance Evaluation Report



REPORT No.: CSSC/BOS/012

ISSUED DATE: August 20, 2021

APPENDIX C. TÜV Rheinland's Report No: CN21ZH49 001. (Cont.)

<b>Test Data / Test Plan</b>			
TÜV Rheinland (Shanghai) Co., Ltd.		Document No.: TD-0189	
Protection and Control requirements for PEA Interface of Inverter based Generation Systems 2016.08		Report No:	CN21ZH49 001
Order No. :	244313300	Product:	Grid-Connected PV Inverter
Client Name :	SolaX Power Network Technology (Zhejiang)Co.,Ltd	Model designation:	X3-Hybrid G4

## Attachment : 1

Picture No.:	76	Clause:	9
Test:	<input type="checkbox"/> Islanding Protection <input type="checkbox"/> Secondary Over Voltage Magnitude <input type="checkbox"/> Secondary Over Voltage Trip Time <input type="checkbox"/> Secondary Under Voltage Magnitude <input type="checkbox"/> Secondary Under Voltage Trip Time <input type="checkbox"/> Under Frequency Magnitude <input type="checkbox"/> Under Frequency Trip Time	<input checked="" type="checkbox"/> First Over Voltage Magnitude <input checked="" type="checkbox"/> First Over Voltage Trip Time <input type="checkbox"/> First Under Voltage Magnitude <input type="checkbox"/> First Under Voltage Trip Time <input type="checkbox"/> Over Frequency Magnitude <input type="checkbox"/> Over Frequency Trip Time <input type="checkbox"/> Response to Utility Recovery	
Test description:	During the first level over voltage test, the L123 grid voltage was jumped to 268.6V approximately, trip time 131. ms. The wave No. 1/2/3 were the grid voltages; The wave No. 5/6/7 were the output currents of inverter; The wave No. 8 was ordered from top to end.		



Used equipment No.: See equipment list for details      Sample No.: N/A

Finished date: \_\_\_\_\_      Tested by: \_\_\_\_\_

Review date: \_\_\_\_\_      Reviewed by: \_\_\_\_\_





# Compliance Evaluation Report



REPORT No.: CSSC/BOS/012

ISSUED DATE: August 20, 2021

APPENDIX C. TÜV Rheinland's Report No: CN21ZH49 001. (Cont.)

<b>Test Data / Test Plan</b>			
TÜV Rheinland (Shanghai) Co., Ltd.		Document No.: TD-0189	
Protection and Control requirements for PEA Interface of Inverter based Generation Systems 2016.08		Report No:	CN21ZH49 001
Order No. :	244313300	Product:	Grid-Connected PV Inverter
Client Name :	SolaX Power Network Technology (Zhejiang)Co.,Ltd	Model designation:	X3-Hybrid G4

## Attachment : 1

Picture No.:	77	Clause:	9
Test:	<input type="checkbox"/> Islanding Protection <input checked="" type="checkbox"/> Secondary Over Voltage Magnitude <input checked="" type="checkbox"/> Secondary Over Voltage Trip Time <input type="checkbox"/> Secondary Under Voltage Magnitude <input type="checkbox"/> Secondary Under Voltage Trip Time <input type="checkbox"/> Under Frequency Magnitude <input type="checkbox"/> Under Frequency Trip Time		<input type="checkbox"/> First Over Voltage Magnitude <input type="checkbox"/> First Over Voltage Trip Time <input type="checkbox"/> First Under Voltage Magnitude <input type="checkbox"/> First Under Voltage Trip Time <input type="checkbox"/> Over Frequency Magnitude <input type="checkbox"/> Over Frequency Trip Time <input type="checkbox"/> Response to Utility Recovery
Test description:	During the second level over voltage test, the L1 grid voltage was jumped to 290V approximately, trip time 106 ms. The wave No. 1/2/3 were the grid voltages; The wave No. 5/6/7 were the output currents of inverter; The wave No. 8 was ordered from top to end.		

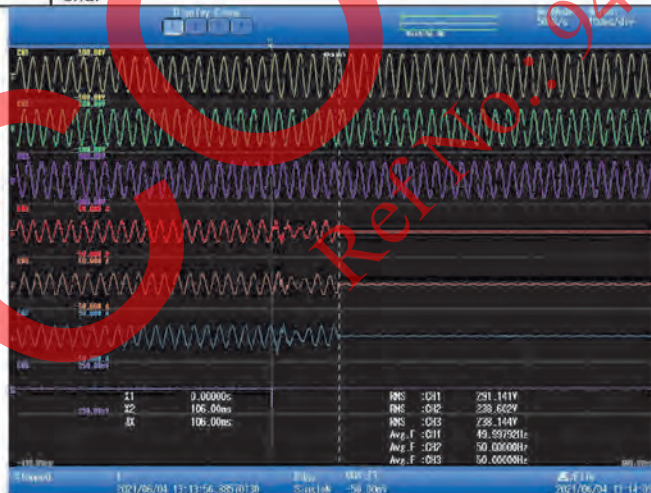

Used equipment No.: See equipment list for details      Sample No.: N/A

Finished date: \_\_\_\_\_      Tested by: \_\_\_\_\_

Review date: \_\_\_\_\_      Reviewed by: \_\_\_\_\_







# Compliance Evaluation Report



REPORT No.: CSSC/BOS/012

ISSUED DATE: August 20, 2021

APPENDIX C. TÜV Rheinland's Report No: CN21ZH49 001. (Cont.)

<b>Test Data / Test Plan</b>			
TÜV Rheinland (Shanghai) Co., Ltd.		Document No.: TD-0189	
Protection and Control requirements for PEA Interface of Inverter based Generation Systems 2016.08		Report No:	CN21ZH49 001
Order No. :	244313300	Product:	Grid-Connected PV Inverter
Client Name :	SolaX Power Network Technology (Zhejiang)Co.,Ltd	Model designation:	X3-Hybrid G4

## Attachment : 1

Picture No.:	78	Clause:	9
Test:	<input type="checkbox"/> Islanding Protection <input checked="" type="checkbox"/> Secondary Over Voltage Magnitude <input checked="" type="checkbox"/> Secondary Over Voltage Trip Time <input type="checkbox"/> Secondary Under Voltage Magnitude <input type="checkbox"/> Secondary Under Voltage Trip Time <input type="checkbox"/> Under Frequency Magnitude <input type="checkbox"/> Under Frequency Trip Time	<input type="checkbox"/> First Over Voltage Magnitude <input type="checkbox"/> First Over Voltage Trip Time <input type="checkbox"/> First Under Voltage Magnitude <input type="checkbox"/> First Under Voltage Trip Time <input type="checkbox"/> Over Frequency Magnitude <input type="checkbox"/> Over Frequency Trip Time <input type="checkbox"/> Response to Utility Recovery	
Test description:	During the second level over voltage test, the L1 grid voltage was jumped to 290V approximately, trip time 134 ms. The wave No. 1/2/3 were the grid voltages; The wave No. 5/6/7 were the output currents of inverter; The wave No. 8 was ordered from top to end.		



Used equipment No.: See equipment list for details

Sample No.: N/A

Finished date:

Tested by:

Review date:

Reviewed by:





# Compliance Evaluation Report



REPORT No.: CSSC/BOS/012

ISSUED DATE: August 20, 2021

APPENDIX C. TÜV Rheinland's Report No: CN21ZH49 001. (Cont.)

<b>Test Data / Test Plan</b>			
TÜV Rheinland (Shanghai) Co., Ltd.		Document No.: TD-0189	
Protection and Control requirements for PEA Interface of Inverter based Generation Systems 2016.08		Report No:	CN21ZH49 001
Order No. :	244313300	Product:	Grid-Connected PV Inverter
Client Name :	SolaX Power Network Technology (Zhejiang)Co.,Ltd	Model designation:	X3-Hybrid G4

## Attachment : 1

Picture No.:	79	Clause:	9
Test:	<input type="checkbox"/> Islanding Protection <input checked="" type="checkbox"/> Secondary Over Voltage Magnitude <input checked="" type="checkbox"/> Secondary Over Voltage Trip Time <input type="checkbox"/> Secondary Under Voltage Magnitude <input type="checkbox"/> Secondary Under Voltage Trip Time <input type="checkbox"/> Under Frequency Magnitude <input type="checkbox"/> Under Frequency Trip Time		<input type="checkbox"/> First Over Voltage Magnitude <input type="checkbox"/> First Over Voltage Trip Time <input type="checkbox"/> First Under Voltage Magnitude <input type="checkbox"/> First Under Voltage Trip Time <input type="checkbox"/> Over Frequency Magnitude <input type="checkbox"/> Over Frequency Trip Time <input type="checkbox"/> Response to Utility Recovery
Test description:	During the second level over voltage test, the L2 grid voltage was jumped to 290V approximately, trip time 117 ms. The wave No. 1/2/3 were the grid voltages; The wave No. 5/6/7 were the output currents of inverter. The wave No. 8 was ordered from top to end.		

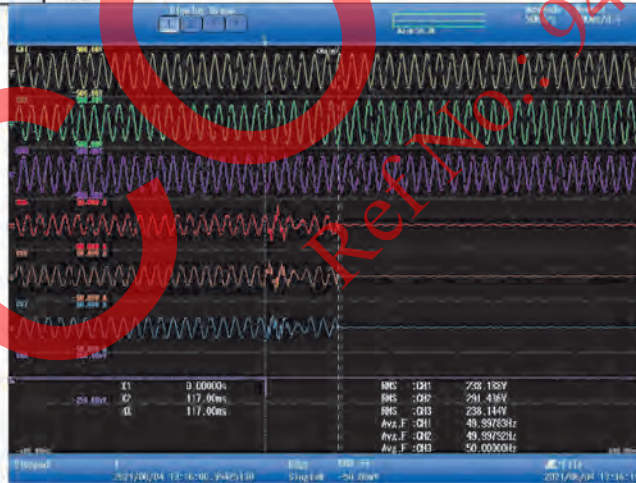

Used equipment No.: See equipment list for details      Sample No.: N/A

Finished date: \_\_\_\_\_      Tested by: \_\_\_\_\_

Review date: \_\_\_\_\_      Reviewed by: \_\_\_\_\_





# Compliance Evaluation Report



REPORT No.: CSSC/BOS/012

ISSUED DATE: August 20, 2021

APPENDIX C. TÜV Rheinland's Report No: CN21ZH49 001. (Cont.)

<b>Test Data / Test Plan</b>			
TÜV Rheinland (Shanghai) Co., Ltd.		Document No.: TD-0189	
Protection and Control requirements for PEA Interface of Inverter based Generation Systems 2016.08		Report No:	CN21ZH49 001
Order No. :	244313300	Product:	Grid-Connected PV Inverter
Client Name :	SolaX Power Network Technology (Zhejiang)Co.,Ltd	Model designation:	X3-Hybrid G4

## Attachment : 1

Picture No.:	80	Clause:	9
Test:	<input type="checkbox"/> Islanding Protection <input checked="" type="checkbox"/> Secondary Over Voltage Magnitude <input checked="" type="checkbox"/> Secondary Over Voltage Trip Time <input type="checkbox"/> Secondary Under Voltage Magnitude <input type="checkbox"/> Secondary Under Voltage Trip Time <input type="checkbox"/> Under Frequency Magnitude <input type="checkbox"/> Under Frequency Trip Time	<input type="checkbox"/> First Over Voltage Magnitude <input type="checkbox"/> First Over Voltage Trip Time <input type="checkbox"/> First Under Voltage Magnitude <input type="checkbox"/> First Under Voltage Trip Time <input type="checkbox"/> Over Frequency Magnitude <input type="checkbox"/> Over Frequency Trip Time <input type="checkbox"/> Response to Utility Recovery	
Test description:	During the second level over voltage test, the L2 grid voltage was jumped to 290V approximately, trip time 118 ms. The wave No. 1/2/3 were the grid voltages; The wave No. 5/6/7 were the output currents of inverter; The wave No. 8 was ordered from top to end.		



Used equipment No.: See equipment list for details      Sample No.: N/A

Finished date: \_\_\_\_\_      Tested by: \_\_\_\_\_

Review date: \_\_\_\_\_      Reviewed by: \_\_\_\_\_





# Compliance Evaluation Report



REPORT No.: CSSC/BOS/012

ISSUED DATE: August 20, 2021

APPENDIX C. TÜV Rheinland's Report No: CN21ZH49 001. (Cont.)

<b>Test Data / Test Plan</b>			
TÜV Rheinland (Shanghai) Co., Ltd.		Document No.: TD-0189	
Protection and Control requirements for PEA Interface of Inverter based Generation Systems 2016.08		Report No:	CN21ZH49 001
Order No. :	244313300	Product:	Grid-Connected PV Inverter
Client Name :	SolaX Power Network Technology (Zhejiang)Co.,Ltd	Model designation:	X3-Hybrid G4

## Attachment : 1

Picture No.:	81	Clause:	9
Test:	<input type="checkbox"/> Islanding Protection <input checked="" type="checkbox"/> Secondary Over Voltage Magnitude <input checked="" type="checkbox"/> Secondary Over Voltage Trip Time <input type="checkbox"/> Secondary Under Voltage Magnitude <input type="checkbox"/> Secondary Under Voltage Trip Time <input type="checkbox"/> Under Frequency Magnitude <input type="checkbox"/> Under Frequency Trip Time	<input type="checkbox"/> First Over Voltage Magnitude <input type="checkbox"/> First Over Voltage Trip Time <input type="checkbox"/> First Under Voltage Magnitude <input type="checkbox"/> First Under Voltage Trip Time <input type="checkbox"/> Over Frequency Magnitude <input type="checkbox"/> Over Frequency Trip Time <input type="checkbox"/> Response to Utility Recovery	
Test description:	During the second level over voltage test, the L3 grid voltage was jumped to 290V approximately, trip time 103 ms. The wave No. 1/2/3 were the grid voltages; The wave No. 5/6/7 were the output currents of inverter. The wave No. 8 was ordered from top to end.		



Used equipment No.: See equipment list for details      Sample No.: N/A

Finished date: \_\_\_\_\_      Tested by: \_\_\_\_\_

Review date: \_\_\_\_\_      Reviewed by: \_\_\_\_\_





# Compliance Evaluation Report



REPORT No.: CSSC/BOS/012

ISSUED DATE: August 20, 2021

APPENDIX C. TÜV Rheinland's Report No: CN21ZH49 001. (Cont.)

<b>Test Data / Test Plan</b>			
TÜV Rheinland (Shanghai) Co., Ltd.		Document No.: TD-0189	
Protection and Control requirements for PEA Interface of Inverter based Generation Systems 2016.08		Report No:	CN21ZH49 001
Order No. :	244313300	Product:	Grid-Connected PV Inverter
Client Name :	SolaX Power Network Technology (Zhejiang)Co.,Ltd	Model designation:	X3-Hybrid G4

## Attachment : 1

Picture No.:	82	Clause:	9
Test:	<input type="checkbox"/> Islanding Protection <input checked="" type="checkbox"/> Secondary Over Voltage Magnitude <input checked="" type="checkbox"/> Secondary Over Voltage Trip Time <input type="checkbox"/> Secondary Under Voltage Magnitude <input type="checkbox"/> Secondary Under Voltage Trip Time <input type="checkbox"/> Under Frequency Magnitude <input type="checkbox"/> Under Frequency Trip Time	<input type="checkbox"/> First Over Voltage Magnitude <input type="checkbox"/> First Over Voltage Trip Time <input type="checkbox"/> First Under Voltage Magnitude <input type="checkbox"/> First Under Voltage Trip Time <input type="checkbox"/> Over Frequency Magnitude <input type="checkbox"/> Over Frequency Trip Time <input type="checkbox"/> Response to Utility Recovery	
Test description:	During the second level over voltage test, the L3 grid voltage was jumped to 290V approximately, trip time 103 ms. The wave No. 1/2/3 were the grid voltages; The wave No. 5/6/7 were the output currents of inverter; The wave No. 8 was ordered from top to end.		



Used equipment No.: See equipment list for details      Sample No.: N/A

Finished date: \_\_\_\_\_      Tested by: \_\_\_\_\_

Review date: \_\_\_\_\_      Reviewed by: \_\_\_\_\_





# Compliance Evaluation Report



REPORT No.: CSSC/BOS/012

ISSUED DATE: August 20, 2021

APPENDIX C. TÜV Rheinland's Report No: CN21ZH49 001. (Cont.)

<b>Test Data / Test Plan</b>			
TÜV Rheinland (Shanghai) Co., Ltd.		Document No.: TD-0189	
Protection and Control requirements for PEA Interface of Inverter based Generation Systems 2016.08		Report No:	CN21ZH49 001
Order No. :	244313300	Product:	Grid-Connected PV Inverter
Client Name :	SolaX Power Network Technology (Zhejiang)Co.,Ltd	Model designation:	X3-Hybrid G4

## Attachment : 1

Picture No.:	83	Clause:	9
Test:	<input type="checkbox"/> Islanding Protection <input checked="" type="checkbox"/> Secondary Over Voltage Magnitude <input checked="" type="checkbox"/> Secondary Over Voltage Trip Time <input type="checkbox"/> Secondary Under Voltage Magnitude <input type="checkbox"/> Secondary Under Voltage Trip Time <input type="checkbox"/> Under Frequency Magnitude <input type="checkbox"/> Under Frequency Trip Time	<input type="checkbox"/> First Over Voltage Magnitude <input type="checkbox"/> First Over Voltage Trip Time <input type="checkbox"/> First Under Voltage Magnitude <input type="checkbox"/> First Under Voltage Trip Time <input type="checkbox"/> Over Frequency Magnitude <input type="checkbox"/> Over Frequency Trip Time <input type="checkbox"/> Response to Utility Recovery	
Test description:	During the second level over voltage test, the L123 grid voltage was jumped to 290V approximately, trip time 110 ms. The wave No. 1/2/3 were the grid voltages; The wave No. 5/6/7 were the output currents of inverter; The wave No. 8 was ordered from top to end.		



Used equipment No.: See equipment list for details      Sample No.: N/A

Finished date: \_\_\_\_\_      Tested by: \_\_\_\_\_

Review date: \_\_\_\_\_      Reviewed by: \_\_\_\_\_





# Compliance Evaluation Report



REPORT No.: CSSC/BOS/012

ISSUED DATE: August 20, 2021

APPENDIX C. TÜV Rheinland's Report No: CN21ZH49 001. (Cont.)

Test Data / Test Plan		TÜVRheinland®	
TÜV Rheinland (Shanghai) Co., Ltd.		Document No.: TD-0189	
Protection and Control requirements for PEA Interface of Inverter based Generation Systems 2016.08		Report No:	CN21ZH49 001
Order No. :	244313300	Product:	Grid-Connected PV Inverter
Client Name :	SolaX Power Network Technology (Zhejiang)Co.,Ltd	Model designation:	X3-Hybrid G4

## Attachment : 1

Picture No.:	84	Clause:	9
Test:	<input type="checkbox"/> Islanding Protection <input checked="" type="checkbox"/> Secondary Over Voltage Magnitude <input checked="" type="checkbox"/> Secondary Over Voltage Trip Time <input type="checkbox"/> Secondary Under Voltage Magnitude <input type="checkbox"/> Secondary Under Voltage Trip Time <input type="checkbox"/> Under Frequency Magnitude <input type="checkbox"/> Under Frequency Trip Time		<input type="checkbox"/> First Over Voltage Magnitude <input type="checkbox"/> First Over Voltage Trip Time <input type="checkbox"/> First Under Voltage Magnitude <input type="checkbox"/> First Under Voltage Trip Time <input type="checkbox"/> Over Frequency Magnitude <input type="checkbox"/> Over Frequency Trip Time <input type="checkbox"/> Response to Utility Recovery
Test description:	During the second level over voltage test, the L123 grid voltage was jumped to 290V approximately, trip time 111 ms. The wave No. 1/2/3 were the grid voltages; The wave No. 5/6/7 were the output currents of inverter. The wave No. 8 was ordered from top to end.		



Used equipment No.: See equipment list for details      Sample No.: N/A

Finished date: \_\_\_\_\_      Tested by: \_\_\_\_\_

Review date: \_\_\_\_\_      Reviewed by: \_\_\_\_\_





# Compliance Evaluation Report



REPORT No.: CSSC/BOS/012

ISSUED DATE: August 20, 2021

APPENDIX C. TÜV Rheinland's Report No: CN21ZH49 001. (Cont.)

<b>Test Data / Test Plan</b>			
TÜV Rheinland (Shanghai) Co., Ltd.		Document No.: TD-0189	
Protection and Control requirements for PEA Interface of Inverter based Generation Systems 2016.08		Report No:	CN21ZH49 001
Order No. :	244313300	Product:	Grid-Connected PV Inverter
Client Name :	SolaX Power Network Technology (Zhejiang)Co.,Ltd	Model designation:	X3-Hybrid G4

## Attachment : 1

Picture No.:	85	Clause:	9
Test:	<input type="checkbox"/> Islanding Protection <input type="checkbox"/> Secondary Over Voltage Magnitude <input type="checkbox"/> Secondary Over Voltage Trip Time <input type="checkbox"/> Secondary Under Voltage Magnitude <input type="checkbox"/> Secondary Under Voltage Trip Time <input type="checkbox"/> Under Frequency Magnitude <input type="checkbox"/> Under Frequency Trip Time	<input type="checkbox"/> First Over Voltage Magnitude <input type="checkbox"/> First Over Voltage Trip Time <input checked="" type="checkbox"/> First Under Voltage Magnitude <input checked="" type="checkbox"/> First Under Voltage Trip Time <input type="checkbox"/> Over Frequency Magnitude <input type="checkbox"/> Over Frequency Trip Time <input type="checkbox"/> Response to Utility Recovery	
Test description:	During the first level under voltage test, the L1 grid voltage was jumped below 176.2V, trip time 1940 ms. The wave No. 1/2/3 were the grid voltages; The wave No. 5/6/7 were the output currents of inverter, The wave No. 8 was ordered from top to end.		



Used equipment No.:	See equipment list for details	Sample No.:	N/A
Finished date:	_____	Tested by:	_____
Review date:	_____	Reviewed by:	_____







# Compliance Evaluation Report



REPORT No.: CSSC/BOS/012

ISSUED DATE: August 20, 2021

APPENDIX C. TÜV Rheinland's Report No: CN21ZH49 001. (Cont.)

<b>Test Data / Test Plan</b>			
TÜV Rheinland (Shanghai) Co., Ltd.		Document No.: TD-0189	
Protection and Control requirements for PEA Interface of Inverter based Generation Systems 2016.08		Report No:	CN21ZH49 001
Order No. :	244313300	Product:	Grid-Connected PV Inverter
Client Name :	SolaX Power Network Technology (Zhejiang)Co.,Ltd	Model designation:	X3-Hybrid G4

## Attachment : 1

Picture No.:	86	Clause:	9
Test:	<input type="checkbox"/> Islanding Protection <input type="checkbox"/> Secondary Over Voltage Magnitude <input type="checkbox"/> Secondary Over Voltage Trip Time <input type="checkbox"/> Secondary Under Voltage Magnitude <input type="checkbox"/> Secondary Under Voltage Trip Time <input type="checkbox"/> Under Frequency Magnitude <input type="checkbox"/> Under Frequency Trip Time		<input type="checkbox"/> First Over Voltage Magnitude <input type="checkbox"/> First Over Voltage Trip Time <input checked="" type="checkbox"/> First Under Voltage Magnitude <input checked="" type="checkbox"/> First Under Voltage Trip Time <input type="checkbox"/> Over Frequency Magnitude <input type="checkbox"/> Over Frequency Trip Time <input type="checkbox"/> Response to Utility Recovery
Test description:	During the first level under voltage test, the L1 grid voltage was jumped below 176.2V, trip time 1942 ms. The wave No. 1/2/3 were the grid voltages; The wave No. 5/6/7 were the output currents of inverter, The wave No. 8 was ordered from top to end.		



Used equipment No.:	See equipment list for details	Sample No.:	N/A
Finished date:	_____	Tested by:	_____
Review date:	_____	Reviewed by:	_____





# Compliance Evaluation Report



REPORT No.: CSSC/BOS/012

ISSUED DATE: August 20, 2021

APPENDIX C. TÜV Rheinland's Report No: CN21ZH49 001. (Cont.)

<b>Test Data / Test Plan</b>			
TÜV Rheinland (Shanghai) Co., Ltd.		Document No.: TD-0189	
Protection and Control requirements for PEA Interface of Inverter based Generation Systems 2016.08		Report No:	CN21ZH49 001
Order No. :	244313300	Product:	Grid-Connected PV Inverter
Client Name :	SolaX Power Network Technology (Zhejiang)Co.,Ltd	Model designation:	X3-Hybrid G4

## Attachment : 1

Picture No.:	87	Clause:	9
Test:	<input type="checkbox"/> Islanding Protection <input type="checkbox"/> Secondary Over Voltage Magnitude <input type="checkbox"/> Secondary Over Voltage Trip Time <input type="checkbox"/> Secondary Under Voltage Magnitude <input type="checkbox"/> Secondary Under Voltage Trip Time <input type="checkbox"/> Under Frequency Magnitude <input type="checkbox"/> Under Frequency Trip Time	<input type="checkbox"/> First Over Voltage Magnitude <input type="checkbox"/> First Over Voltage Trip Time <input checked="" type="checkbox"/> First Under Voltage Magnitude <input checked="" type="checkbox"/> First Under Voltage Trip Time <input type="checkbox"/> Over Frequency Magnitude <input type="checkbox"/> Over Frequency Trip Time <input type="checkbox"/> Response to Utility Recovery	
Test description:	During the first level under voltage test, the L2 grid voltage was jumped below 176.2V, trip time 1931 ms. The wave No. 1/2/3 were the grid voltages; The wave No. 5/6/7 were the output currents of inverter, The wave No. 8 was ordered from top to end.		

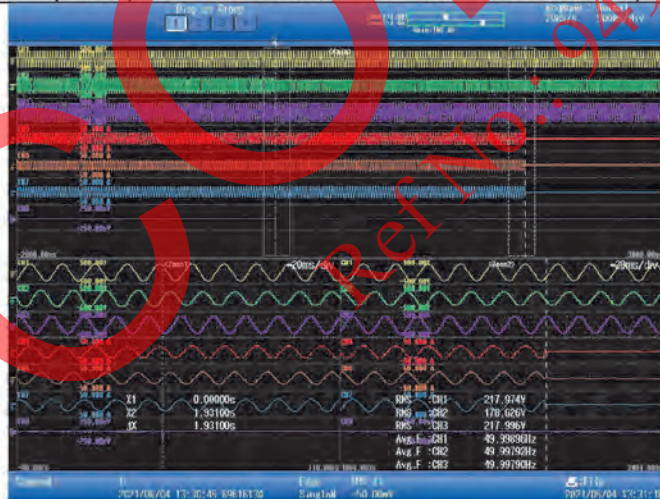

Used equipment No.: See equipment list for details      Sample No.: N/A

Finished date: \_\_\_\_\_      Tested by: \_\_\_\_\_

Review date: \_\_\_\_\_      Reviewed by: \_\_\_\_\_





# Compliance Evaluation Report



REPORT No.: CSSC/BOS/012

ISSUED DATE: August 20, 2021

APPENDIX C. TÜV Rheinland's Report No: CN21ZH49 001. (Cont.)

<b>Test Data / Test Plan</b>			
TÜV Rheinland (Shanghai) Co., Ltd.		Document No.: TD-0189	
Protection and Control requirements for PEA Interface of Inverter based Generation Systems 2016.08		Report No:	CN21ZH49 001
Order No. :	244313300	Product:	Grid-Connected PV Inverter
Client Name :	SolaX Power Network Technology (Zhejiang)Co.,Ltd	Model designation:	X3-Hybrid G4

## Attachment : 1

Picture No.:	88	Clause:	9
Test:	<input type="checkbox"/> Islanding Protection <input type="checkbox"/> Secondary Over Voltage Magnitude <input type="checkbox"/> Secondary Over Voltage Trip Time <input type="checkbox"/> Secondary Under Voltage Magnitude <input type="checkbox"/> Secondary Under Voltage Trip Time <input type="checkbox"/> Under Frequency Magnitude <input type="checkbox"/> Under Frequency Trip Time	<input type="checkbox"/> First Over Voltage Magnitude <input type="checkbox"/> First Over Voltage Trip Time <input checked="" type="checkbox"/> First Under Voltage Magnitude <input checked="" type="checkbox"/> First Under Voltage Trip Time <input type="checkbox"/> Over Frequency Magnitude <input type="checkbox"/> Over Frequency Trip Time <input type="checkbox"/> Response to Utility Recovery	
Test description:	During the first level under voltage test, the L2 grid voltage was jumped below 176.2V, trip time 1929.8 ms. The wave No. 1/2/3 were the grid voltages; The wave No. 5/6/7 were the output currents of inverter. The wave No. 8 was ordered from top to end.		

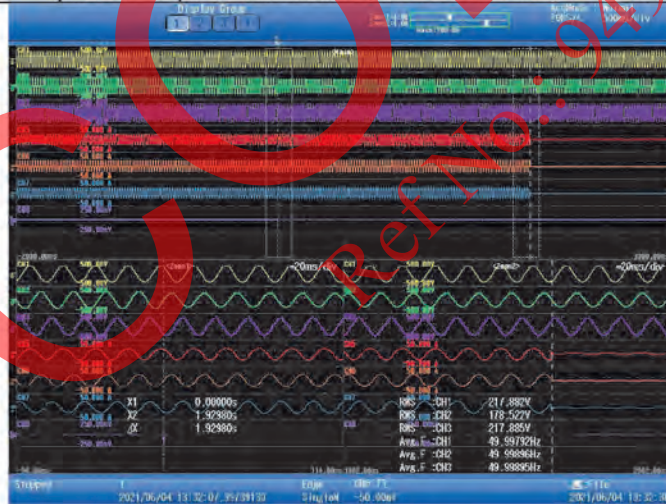

Used equipment No.: See equipment list for details      Sample No.: N/A

Finished date: \_\_\_\_\_      Tested by: \_\_\_\_\_

Review date: \_\_\_\_\_      Reviewed by: \_\_\_\_\_





# Compliance Evaluation Report



REPORT No.: CSSC/BOS/012

ISSUED DATE: August 20, 2021

APPENDIX C. TÜV Rheinland's Report No: CN21ZH49 001. (Cont.)

Test Data / Test Plan		TÜVRheinland®	
TÜV Rheinland (Shanghai) Co., Ltd.		Document No.: TD-0189	
Protection and Control requirements for PEA Interface of Inverter based Generation Systems 2016.08		Report No:	CN21ZH49 001
Order No. :	244313300	Product:	Grid-Connected PV Inverter
Client Name :	SolaX Power Network Technology (Zhejiang)Co.,Ltd	Model designation:	X3-Hybrid G4

## Attachment : 1

Picture No.:	89	Clause:	9
Test:	<input type="checkbox"/> Islanding Protection <input type="checkbox"/> Secondary Over Voltage Magnitude <input type="checkbox"/> Secondary Over Voltage Trip Time <input type="checkbox"/> Secondary Under Voltage Magnitude <input type="checkbox"/> Secondary Under Voltage Trip Time <input type="checkbox"/> Under Frequency Magnitude <input type="checkbox"/> Under Frequency Trip Time		<input type="checkbox"/> First Over Voltage Magnitude <input type="checkbox"/> First Over Voltage Trip Time <input checked="" type="checkbox"/> First Under Voltage Magnitude <input checked="" type="checkbox"/> First Under Voltage Trip Time <input type="checkbox"/> Over Frequency Magnitude <input type="checkbox"/> Over Frequency Trip Time <input type="checkbox"/> Response to Utility Recovery
Test description:	During the first level under voltage test, the L3 grid voltage was jumped below 176.2V, trip time 1941 ms. The wave No. 1/2/3 were the grid voltages; The wave No. 5/6/7 were the output currents of inverter, The wave No. 8 was ordered from top to end.		

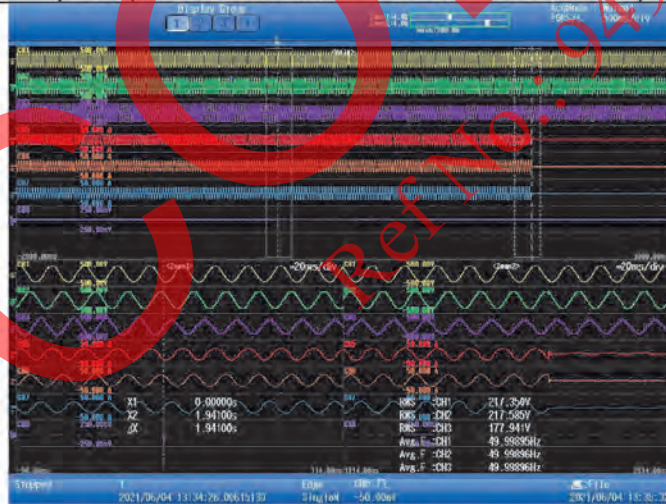

Used equipment No.: See equipment list for details      Sample No.: N/A

Finished date: \_\_\_\_\_      Tested by: \_\_\_\_\_

Review date: \_\_\_\_\_      Reviewed by: \_\_\_\_\_





# Compliance Evaluation Report



REPORT No.: CSSC/BOS/012

ISSUED DATE: August 20, 2021

APPENDIX C. TÜV Rheinland's Report No: CN21ZH49 001. (Cont.)

<b>Test Data / Test Plan</b>			
TÜV Rheinland (Shanghai) Co., Ltd.		Document No.: TD-0189	
Protection and Control requirements for PEA Interface of Inverter based Generation Systems 2016.08		Report No:	CN21ZH49 001
Order No. :	244313300	Product:	Grid-Connected PV Inverter
Client Name :	SolaX Power Network Technology (Zhejiang)Co.,Ltd	Model designation:	X3-Hybrid G4

## Attachment : 1

Picture No.:	90	Clause:	9
Test:	<input type="checkbox"/> Islanding Protection <input type="checkbox"/> Secondary Over Voltage Magnitude <input type="checkbox"/> Secondary Over Voltage Trip Time <input type="checkbox"/> Secondary Under Voltage Magnitude <input type="checkbox"/> Secondary Under Voltage Trip Time <input type="checkbox"/> Under Frequency Magnitude <input type="checkbox"/> Under Frequency Trip Time	<input type="checkbox"/> First Over Voltage Magnitude <input type="checkbox"/> First Over Voltage Trip Time <input checked="" type="checkbox"/> First Under Voltage Magnitude <input checked="" type="checkbox"/> First Under Voltage Trip Time <input type="checkbox"/> Over Frequency Magnitude <input type="checkbox"/> Over Frequency Trip Time <input type="checkbox"/> Response to Utility Recovery	
Test description:	During the first level under voltage test, the L3 grid voltage was jumped below 176.2V, trip time 1941.3 ms. The wave No. 1/2/3 were the grid voltages; The wave No. 5/6/7 were the output currents of inverter, The wave No. 8 was ordered from top to end.		



Used equipment No.: See equipment list for details      Sample No.: N/A

Finished date: \_\_\_\_\_      Tested by: \_\_\_\_\_

Review date: \_\_\_\_\_      Reviewed by: \_\_\_\_\_





# Compliance Evaluation Report



REPORT No.: CSSC/BOS/012

ISSUED DATE: August 20, 2021

APPENDIX C. TÜV Rheinland's Report No: CN21ZH49 001. (Cont.)

<b>Test Data / Test Plan</b>			
TÜV Rheinland (Shanghai) Co., Ltd.		Document No.: TD-0189	
Protection and Control requirements for PEA Interface of Inverter based Generation Systems 2016.08		Report No:	CN21ZH49 001
Order No. :	244313300	Product:	Grid-Connected PV Inverter
Client Name :	SolaX Power Network Technology (Zhejiang)Co.,Ltd	Model designation:	X3-Hybrid G4

## Attachment : 1

Picture No.:	91	Clause:	9
Test:	<input type="checkbox"/> Islanding Protection <input type="checkbox"/> Secondary Over Voltage Magnitude <input type="checkbox"/> Secondary Over Voltage Trip Time <input type="checkbox"/> Secondary Under Voltage Magnitude <input type="checkbox"/> Secondary Under Voltage Trip Time <input type="checkbox"/> Under Frequency Magnitude <input type="checkbox"/> Under Frequency Trip Time	<input type="checkbox"/> First Over Voltage Magnitude <input type="checkbox"/> First Over Voltage Trip Time <input checked="" type="checkbox"/> First Under Voltage Magnitude <input checked="" type="checkbox"/> First Under Voltage Trip Time <input type="checkbox"/> Over Frequency Magnitude <input type="checkbox"/> Over Frequency Trip Time <input type="checkbox"/> Response to Utility Recovery	
Test description:	During the first level under voltage test, the L123 grid voltage was jumped below 176.2V, trip time 1923.1 ms. The wave No. 1/2/3 were the grid voltages; The wave No. 5/6/7 were the output currents of inverter. The wave No. 8 was ordered from top to end.		



Used equipment No.: See equipment list for details      Sample No.: N/A

Finished date: \_\_\_\_\_      Tested by: \_\_\_\_\_

Review date: \_\_\_\_\_      Reviewed by: \_\_\_\_\_





# Compliance Evaluation Report



REPORT No.: CSSC/BOS/012

ISSUED DATE: August 20, 2021

APPENDIX C. TÜV Rheinland's Report No: CN21ZH49 001. (Cont.)

<b>Test Data / Test Plan</b>		TÜVRheinland®	
TÜV Rheinland (Shanghai) Co., Ltd.		Document No.: TD-0189	
Protection and Control requirements for PEA Interface of Inverter based Generation Systems 2016.08		Report No:	CN21ZH49 001
Order No. :	244313300	Product:	Grid-Connected PV Inverter
Client Name :	SolaX Power Network Technology (Zhejiang)Co.,Ltd	Model designation:	X3-Hybrid G4

## Attachment : 1

Picture No.:	92	Clause:	9
Test:	<input type="checkbox"/> Islanding Protection <input type="checkbox"/> Secondary Over Voltage Magnitude <input type="checkbox"/> Secondary Over Voltage Trip Time <input type="checkbox"/> Secondary Under Voltage Magnitude <input type="checkbox"/> Secondary Under Voltage Trip Time <input type="checkbox"/> Under Frequency Magnitude <input type="checkbox"/> Under Frequency Trip Time	<input type="checkbox"/> First Over Voltage Magnitude <input type="checkbox"/> First Over Voltage Trip Time <input checked="" type="checkbox"/> First Under Voltage Magnitude <input checked="" type="checkbox"/> First Under Voltage Trip Time <input type="checkbox"/> Over Frequency Magnitude <input type="checkbox"/> Over Frequency Trip Time <input type="checkbox"/> Response to Utility Recovery	
Test description:	During the first level under voltage test, the L123 grid voltage was jumped to 176.2V approximately, trip time 1925.7 ms. The wave No. 1/2/3 were the grid voltages; The wave No. 5/6/7 were the output currents of inverter; The wave No. 8 was ordered from top to end.		



Used equipment No.: See equipment list for details      Sample No.: N/A

Finished date: \_\_\_\_\_      Tested by: \_\_\_\_\_

Review date: \_\_\_\_\_      Reviewed by: \_\_\_\_\_





# Compliance Evaluation Report



REPORT No.: CSSC/BOS/012

ISSUED DATE: August 20, 2021

APPENDIX C. TÜV Rheinland's Report No: CN21ZH49 001. (Cont.)

<b>Test Data / Test Plan</b>			
TÜV Rheinland (Shanghai) Co., Ltd.		Document No.: TD-0189	
Protection and Control requirements for PEA Interface of Inverter based Generation Systems 2016.08		Report No:	CN21ZH49 001
Order No. :	244313300	Product:	Grid-Connected PV Inverter
Client Name :	SolaX Power Network Technology (Zhejiang)Co.,Ltd	Model designation:	X3-Hybrid G4

## Attachment : 1

Picture No.:	93	Clause:	9
Test:	<input type="checkbox"/> Islanding Protection <input type="checkbox"/> Secondary Over Voltage Magnitude <input type="checkbox"/> Secondary Over Voltage Trip Time <input checked="" type="checkbox"/> Secondary Under Voltage Magnitude <input type="checkbox"/> Secondary Under Voltage Trip Time <input type="checkbox"/> Under Frequency Magnitude <input type="checkbox"/> Under Frequency Trip Time	<input type="checkbox"/> First Over Voltage Magnitude <input type="checkbox"/> First Over Voltage Trip Time <input type="checkbox"/> First Under Voltage Magnitude <input type="checkbox"/> First Under Voltage Trip Time <input type="checkbox"/> Over Frequency Magnitude <input type="checkbox"/> Over Frequency Trip Time <input type="checkbox"/> Response to Utility Recovery	
Test description:	During the second level under voltage test, the L1 grid voltage was jumped to 97V approximately, trip time 243 ms. The wave No. 1/2/3 were the grid voltages; The wave No. 5/6/7 were the output currents of inverter; The wave No. 8 was ordered from top to end.		



Used equipment No.: See equipment list for details      Sample No.: N/A

Finished date: \_\_\_\_\_      Tested by: \_\_\_\_\_

Review date: \_\_\_\_\_      Reviewed by: \_\_\_\_\_







# Compliance Evaluation Report



REPORT No.: CSSC/BOS/012

ISSUED DATE: August 20, 2021

APPENDIX C. TÜV Rheinland's Report No: CN21ZH49 001. (Cont.)

<b>Test Data / Test Plan</b>			
TÜV Rheinland (Shanghai) Co., Ltd.		Document No.: TD-0189	
Protection and Control requirements for PEA Interface of Inverter based Generation Systems 2016.08		Report No:	CN21ZH49 001
Order No. :	244313300	Product:	Grid-Connected PV Inverter
Client Name :	SolaX Power Network Technology (Zhejiang)Co.,Ltd	Model designation:	X3-Hybrid G4

## Attachment : 1

Picture No.:	94	Clause:	9
Test:	<input type="checkbox"/> Islanding Protection <input type="checkbox"/> Secondary Over Voltage Magnitude <input type="checkbox"/> Secondary Over Voltage Trip Time <input checked="" type="checkbox"/> Secondary Under Voltage Magnitude <input checked="" type="checkbox"/> Secondary Under Voltage Trip Time <input type="checkbox"/> Under Frequency Magnitude <input type="checkbox"/> Under Frequency Trip Time	<input type="checkbox"/> First Over Voltage Magnitude <input type="checkbox"/> First Over Voltage Trip Time <input type="checkbox"/> First Under Voltage Magnitude <input type="checkbox"/> First Under Voltage Trip Time <input type="checkbox"/> Over Frequency Magnitude <input type="checkbox"/> Over Frequency Trip Time <input type="checkbox"/> Response to Utility Recovery	
Test description:	During the second level under voltage test, the L1 grid voltage was jumped to 97V approximately, trip time 224 ms. The wave No. 1/2/3 were the grid voltages; The wave No. 5/6/7 were the output currents of inverter; The wave No. 8 was ordered from top to end.		

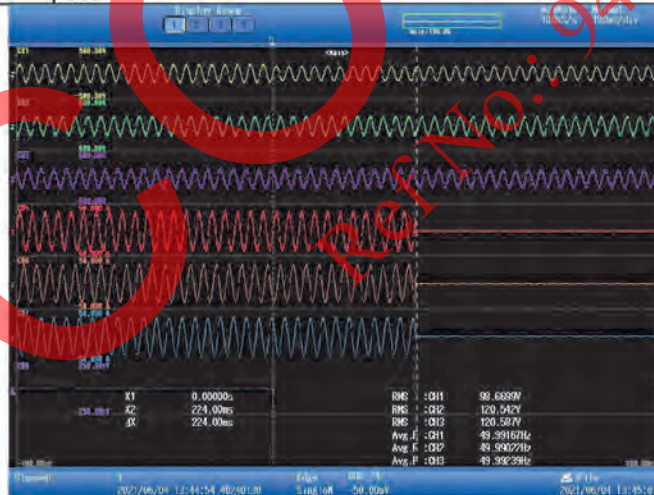

Used equipment No.: See equipment list for details      Sample No.: N/A  
 Finished date: \_\_\_\_\_      Tested by: \_\_\_\_\_  
 Review date: \_\_\_\_\_      Reviewed by: \_\_\_\_\_





# Compliance Evaluation Report



REPORT No.: CSSC/BOS/012

ISSUED DATE: August 20, 2021

APPENDIX C. TÜV Rheinland's Report No: CN21ZH49 001. (Cont.)

<b>Test Data / Test Plan</b>			
TÜV Rheinland (Shanghai) Co., Ltd.		Document No.: TD-0189	
Protection and Control requirements for PEA Interface of Inverter based Generation Systems 2016.08		Report No:	CN21ZH49 001
Order No. :	244313300	Product:	Grid-Connected PV Inverter
Client Name :	SolaX Power Network Technology (Zhejiang)Co.,Ltd	Model designation:	X3-Hybrid G4

## Attachment : 1

Picture No.:	95	Clause:	9
Test:	<input type="checkbox"/> Islanding Protection <input type="checkbox"/> Secondary Over Voltage Magnitude <input type="checkbox"/> Secondary Over Voltage Trip Time <input checked="" type="checkbox"/> Secondary Under Voltage Magnitude <input type="checkbox"/> Secondary Under Voltage Trip Time <input type="checkbox"/> Under Frequency Magnitude <input type="checkbox"/> Under Frequency Trip Time	<input type="checkbox"/> First Over Voltage Magnitude <input type="checkbox"/> First Over Voltage Trip Time <input type="checkbox"/> First Under Voltage Magnitude <input type="checkbox"/> First Under Voltage Trip Time <input type="checkbox"/> Over Frequency Magnitude <input type="checkbox"/> Over Frequency Trip Time <input type="checkbox"/> Response to Utility Recovery	
Test description:	During the second level under voltage test, the L2 grid voltage was jumped to 97V approximately, trip time 231 ms. The wave No. 1/2/3 were the grid voltages; The wave No. 5/6/7 were the output currents of inverter; The wave No. 8 was ordered from top to end.		



Used equipment No.: See equipment list for details      Sample No.: N/A

Finished date: \_\_\_\_\_      Tested by: \_\_\_\_\_

Review date: \_\_\_\_\_      Reviewed by: \_\_\_\_\_





# Compliance Evaluation Report



REPORT No.: CSSC/BOS/012

ISSUED DATE: August 20, 2021

APPENDIX C. TÜV Rheinland's Report No: CN21ZH49 001. (Cont.)

<b>Test Data / Test Plan</b>			
TÜV Rheinland (Shanghai) Co., Ltd.		Document No.: TD-0189	
Protection and Control requirements for PEA Interface of Inverter based Generation Systems 2016.08		Report No:	CN21ZH49 001
Order No. :	244313300	Product:	Grid-Connected PV Inverter
Client Name :	SolaX Power Network Technology (Zhejiang)Co.,Ltd	Model designation:	X3-Hybrid G4

## Attachment : 1

Picture No.:	96	Clause:	9
Test:	<input type="checkbox"/> Islanding Protection <input type="checkbox"/> Secondary Over Voltage Magnitude <input type="checkbox"/> Secondary Over Voltage Trip Time <input checked="" type="checkbox"/> Secondary Under Voltage Magnitude <input type="checkbox"/> Secondary Under Voltage Trip Time <input type="checkbox"/> Under Frequency Magnitude <input type="checkbox"/> Under Frequency Trip Time	<input type="checkbox"/> First Over Voltage Magnitude <input type="checkbox"/> First Over Voltage Trip Time <input type="checkbox"/> First Under Voltage Magnitude <input type="checkbox"/> First Under Voltage Trip Time <input type="checkbox"/> Over Frequency Magnitude <input type="checkbox"/> Over Frequency Trip Time <input type="checkbox"/> Response to Utility Recovery	
Test description:	During the second level under voltage test, the L2 grid voltage was jumped to 97V approximately, trip time 231.5 ms. The wave No. 1/2/3 were the grid voltages; The wave No. 5/6/7 were the output currents of inverter; The wave No. 8 was ordered from top to end.		

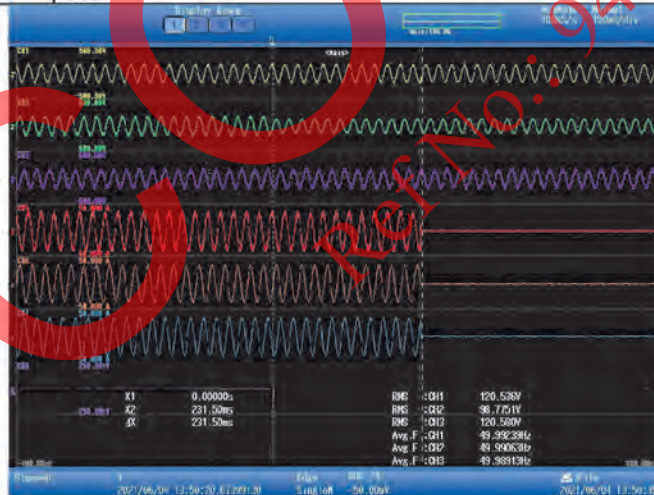

Used equipment No.: See equipment list for details      Sample No.: N/A

Finished date: \_\_\_\_\_      Tested by: \_\_\_\_\_

Review date: \_\_\_\_\_      Reviewed by: \_\_\_\_\_





# Compliance Evaluation Report



REPORT No.: CSSC/BOS/012

ISSUED DATE: August 20, 2021

APPENDIX C. TÜV Rheinland's Report No: CN21ZH49 001. (Cont.)

<b>Test Data / Test Plan</b>			
TÜV Rheinland (Shanghai) Co., Ltd.		Document No.: TD-0189	
Protection and Control requirements for PEA Interface of Inverter based Generation Systems 2016.08		Report No:	CN21ZH49 001
Order No. :	244313300	Product:	Grid-Connected PV Inverter
Client Name :	SolaX Power Network Technology (Zhejiang)Co.,Ltd	Model designation:	X3-Hybrid G4

## Attachment : 1

Picture No.:	97	Clause:	9
Test:	<input type="checkbox"/> Islanding Protection <input type="checkbox"/> Secondary Over Voltage Magnitude <input type="checkbox"/> Secondary Over Voltage Trip Time <input checked="" type="checkbox"/> Secondary Under Voltage Magnitude <input type="checkbox"/> Secondary Under Voltage Trip Time <input type="checkbox"/> Under Frequency Magnitude <input type="checkbox"/> Under Frequency Trip Time	<input type="checkbox"/> First Over Voltage Magnitude <input type="checkbox"/> First Over Voltage Trip Time <input type="checkbox"/> First Under Voltage Magnitude <input type="checkbox"/> First Under Voltage Trip Time <input type="checkbox"/> Over Frequency Magnitude <input type="checkbox"/> Over Frequency Trip Time <input type="checkbox"/> Response to Utility Recovery	
Test description:	During the second level under voltage test, the L3 grid voltage was jumped to 97V approximately, trip time 243 ms. The wave No. 1/2/3 were the grid voltages; The wave No. 5/6/7 were the output currents of inverter; The wave No. 8 was ordered from top to end.		



Used equipment No.: See equipment list for details      Sample No.: N/A

Finished date: \_\_\_\_\_      Tested by: \_\_\_\_\_

Review date: \_\_\_\_\_      Reviewed by: \_\_\_\_\_





# Compliance Evaluation Report



REPORT No.: CSSC/BOS/012

ISSUED DATE: August 20, 2021

APPENDIX C. TÜV Rheinland's Report No: CN21ZH49 001. (Cont.)

Test Data / Test Plan		TÜVRheinland®	
TÜV Rheinland (Shanghai) Co., Ltd.		Document No.: TD-0189	
Protection and Control requirements for PEA Interface of Inverter based Generation Systems 2016.08		Report No:	CN21ZH49 001
Order No. :	244313300	Product:	Grid-Connected PV Inverter
Client Name :	SolaX Power Network Technology (Zhejiang)Co.,Ltd	Model designation:	X3-Hybrid G4

## Attachment : 1

Picture No.:	98	Clause:	9
Test:	<input type="checkbox"/> Islanding Protection <input type="checkbox"/> Secondary Over Voltage Magnitude <input type="checkbox"/> Secondary Over Voltage Trip Time <input checked="" type="checkbox"/> Secondary Under Voltage Magnitude <input type="checkbox"/> Secondary Under Voltage Trip Time <input type="checkbox"/> Under Frequency Magnitude <input type="checkbox"/> Under Frequency Trip Time		<input type="checkbox"/> First Over Voltage Magnitude <input type="checkbox"/> First Over Voltage Trip Time <input type="checkbox"/> First Under Voltage Magnitude <input type="checkbox"/> First Under Voltage Trip Time <input type="checkbox"/> Over Frequency Magnitude <input type="checkbox"/> Over Frequency Trip Time <input type="checkbox"/> Response to Utility Recovery
Test description:	During the second level under voltage test, the L3 grid voltage was jumped to 97V approximately, trip time 239 ms. The wave No. 1/2/3 were the grid voltages; The wave No. 5/6/7 were the output currents of inverter; The wave No. 8 was ordered from top to end.		



Used equipment No.: See equipment list for details      Sample No.: N/A  
 Finished date: \_\_\_\_\_      Tested by: \_\_\_\_\_  
 Review date: \_\_\_\_\_      Reviewed by: \_\_\_\_\_





# Compliance Evaluation Report



REPORT No.: CSSC/BOS/012

ISSUED DATE: August 20, 2021

APPENDIX C. TÜV Rheinland's Report No: CN21ZH49 001. (Cont.)

<b>Test Data / Test Plan</b>			
TÜV Rheinland (Shanghai) Co., Ltd.		Document No.: TD-0189	
Protection and Control requirements for PEA Interface of Inverter based Generation Systems 2016.08		Report No:	CN21ZH49 001
Order No. :	244313300	Product:	Grid-Connected PV Inverter
Client Name :	SolaX Power Network Technology (Zhejiang)Co.,Ltd	Model designation:	X3-Hybrid G4

## Attachment : 1

Picture No.:	99	Clause:	9
Test:	<input type="checkbox"/> Islanding Protection <input type="checkbox"/> Secondary Over Voltage Magnitude <input type="checkbox"/> Secondary Over Voltage Trip Time <input checked="" type="checkbox"/> Secondary Under Voltage Magnitude <input type="checkbox"/> Secondary Under Voltage Trip Time <input type="checkbox"/> Under Frequency Magnitude <input type="checkbox"/> Under Frequency Trip Time	<input type="checkbox"/> First Over Voltage Magnitude <input type="checkbox"/> First Over Voltage Trip Time <input type="checkbox"/> First Under Voltage Magnitude <input type="checkbox"/> First Under Voltage Trip Time <input type="checkbox"/> Over Frequency Magnitude <input type="checkbox"/> Over Frequency Trip Time <input type="checkbox"/> Response to Utility Recovery	
Test description:	During the second level under voltage test, the L123 grid voltage was jumped to 97V approximately, trip time 226 ms. The wave No. 1/2/3 were the grid voltages; The wave No. 5/6/7 were the output currents of inverter; The wave No. 8 was ordered from top to end.		

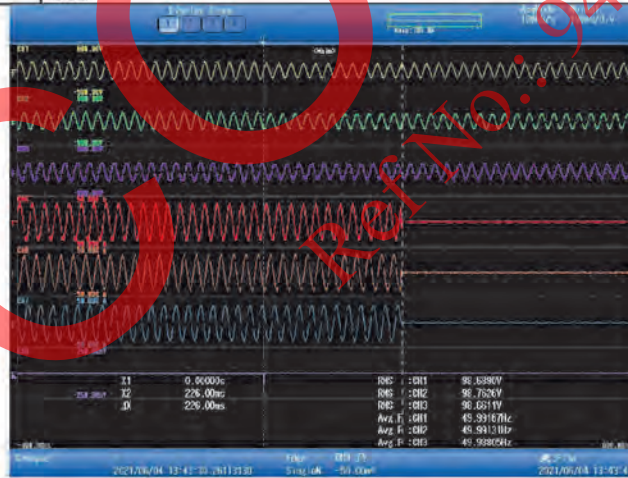

Used equipment No.: See equipment list for details      Sample No.: N/A

Finished date: \_\_\_\_\_      Tested by: \_\_\_\_\_

Review date: \_\_\_\_\_      Reviewed by: \_\_\_\_\_





# Compliance Evaluation Report



REPORT No.: CSSC/BOS/012

ISSUED DATE: August 20, 2021

APPENDIX C. TÜV Rheinland's Report No: CN21ZH49 001. (Cont.)

<b>Test Data / Test Plan</b>			
TÜV Rheinland (Shanghai) Co., Ltd.		Document No.: TD-0189	
Protection and Control requirements for PEA Interface of Inverter based Generation Systems 2016.08		Report No:	CN21ZH49 001
Order No. :	244313300	Product:	Grid-Connected PV Inverter
Client Name :	SolaX Power Network Technology (Zhejiang)Co.,Ltd	Model designation:	X3-Hybrid G4

## Attachment : 1

Picture No.:	100	Clause:	9
Test:	<input type="checkbox"/> Islanding Protection <input type="checkbox"/> Secondary Over Voltage Magnitude <input type="checkbox"/> Secondary Over Voltage Trip Time <input checked="" type="checkbox"/> Secondary Under Voltage Magnitude <input type="checkbox"/> Secondary Under Voltage Trip Time <input type="checkbox"/> Under Frequency Magnitude <input type="checkbox"/> Under Frequency Trip Time	<input type="checkbox"/> First Over Voltage Magnitude <input type="checkbox"/> First Over Voltage Trip Time <input type="checkbox"/> First Under Voltage Magnitude <input type="checkbox"/> First Under Voltage Trip Time <input type="checkbox"/> Over Frequency Magnitude <input type="checkbox"/> Over Frequency Trip Time <input type="checkbox"/> Response to Utility Recovery	
Test description:	During the second level under voltage test, the L123 grid voltage was jumped to 97V approximately, trip time 227 ms. The wave No. 1/2/3 were the grid voltages; The wave No. 5/6/7 were the output currents of inverter; The wave No. 8 was ordered from top to end.		

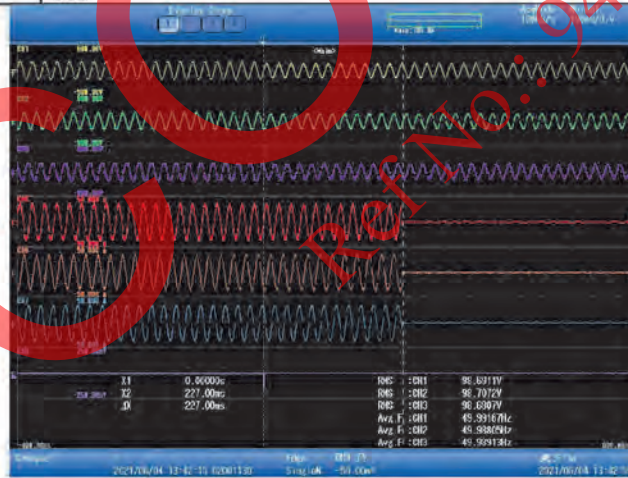

Used equipment No.: See equipment list for details

Sample No.: N/A

Finished date:

Tested by:

Review date:

Reviewed by:





# Compliance Evaluation Report



REPORT No.: CSSC/BOS/012

ISSUED DATE: August 20, 2021

APPENDIX C. TÜV Rheinland's Report No: CN21ZH49 001. (Cont.)

<b>Test Data / Test Plan</b>			
TÜV Rheinland (Shanghai) Co., Ltd.		Document No.: TD-0189	
Protection and Control requirements for PEA Interface of Inverter based Generation Systems 2016.08		Report No:	CN21ZH49 001
Order No. :	244313300	Product:	Grid-Connected PV Inverter
Client Name :	SolaX Power Network Technology (Zhejiang)Co.,Ltd	Model designation:	X3-Hybrid G4

## Attachment : 1

Picture No.:	101	Clause:	11
Test:	<input type="checkbox"/> Islanding Protection <input type="checkbox"/> Secondary Over Voltage Magnitude <input type="checkbox"/> Secondary Over Voltage Trip Time <input type="checkbox"/> Secondary Under Voltage Magnitude <input type="checkbox"/> Secondary Under Voltage Trip Time <input type="checkbox"/> Under Frequency Magnitude <input type="checkbox"/> Under Frequency Trip Time <input type="checkbox"/> First Over Voltage Magnitude <input type="checkbox"/> First Over Voltage Trip Time <input type="checkbox"/> First Under Voltage Magnitude <input type="checkbox"/> First Under Voltage Trip Time <input checked="" type="checkbox"/> Over Frequency Magnitude <input checked="" type="checkbox"/> Over Frequency Trip Time <input type="checkbox"/> Low voltage ride through		
Test description:	During the over frequency test the frequency magnitude was jumped to 52.6Hz approximately, trip time 62 ms. CH1/2/3 were grid voltages; CH8/9/10 were output currents of inverter. CH8 was the trip signal while the grid voltage frequency changed; The wave No. was ordered from top to end.		

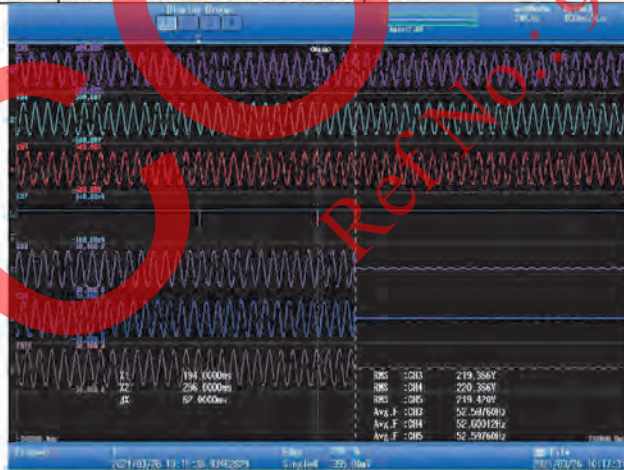

Used equipment No.: See equipment list for details      Sample No.: N/A

Finished date: \_\_\_\_\_      Tested by: \_\_\_\_\_

Review date: \_\_\_\_\_      Reviewed by: \_\_\_\_\_







# Compliance Evaluation Report



REPORT No.: CSSC/BOS/012

ISSUED DATE: August 20, 2021

APPENDIX C. TÜV Rheinland's Report No: CN21ZH49 001. (Cont.)

Test Data / Test Plan		TÜVRheinland®	
TÜV Rheinland (Shanghai) Co., Ltd.		Document No.: TD-0189	
Protection and Control requirements for PEA Interface of Inverter based Generation Systems 2016.08		Report No:	CN21ZH49 001
Order No. :	244313300	Product:	Grid-Connected PV Inverter
Client Name :	SolaX Power Network Technology (Zhejiang)Co.,Ltd	Model designation:	X3-Hybrid G4

## Attachment : 1

Picture No.:	102	Clause:	11
Test:	<input type="checkbox"/> Islanding Protection <input type="checkbox"/> Secondary Over Voltage Magnitude <input type="checkbox"/> Secondary Over Voltage Trip Time <input type="checkbox"/> Secondary Under Voltage Magnitude <input type="checkbox"/> Secondary Under Voltage Trip Time <input checked="" type="checkbox"/> Under Frequency Magnitude <input checked="" type="checkbox"/> Under Frequency Trip Time		<input type="checkbox"/> First Over Voltage Magnitude <input type="checkbox"/> First Over Voltage Trip Time <input type="checkbox"/> First Under Voltage Magnitude <input type="checkbox"/> First Under Voltage Trip Time <input type="checkbox"/> Over Frequency Magnitude <input type="checkbox"/> Over Frequency Trip Time <input type="checkbox"/> Low voltage ride through
Test description:	During the under frequency test the frequency magnitude was jumped to 46.4Hz approximately, trip time 62 ms. CH1/2/3 were grid voltages; CH8/9/10 were output currents of inverter. CH8 was the trip signal while the grid voltage frequency changed. The wave No. was ordered from top to end.		



Used equipment No.: See equipment list for details      Sample No.: N/A

Finished date: \_\_\_\_\_      Tested by: \_\_\_\_\_

Review date: \_\_\_\_\_      Reviewed by: \_\_\_\_\_





# Compliance Evaluation Report



REPORT No.: CSSC/BOS/012

ISSUED DATE: August 20, 2021

APPENDIX C. TÜV Rheinland's Report No: CN21ZH49 001. (Cont.)

Test Data / Test Plan		TÜVRheinland®	
TÜV Rheinland (Shanghai) Co., Ltd.		Document No.: TD-0189	
Protection and Control requirements for PEA Interface of Inverter based Generation Systems 2016.08		Report No:	CN21ZH49 001
Order No. :	244313300	Product:	Grid-Connected PV Inverter
Client Name :	SolaX Power Network Technology (Zhejiang)Co.,Ltd	Model designation:	X3-Hybrid G4

## Attachment : 1



Used equipment No.: See equipment list for details

Sample No.: N/A

Finished date:

Tested by:

Review date:

Reviewed by:



# Compliance Evaluation Report



REPORT No.: CSSC/BOS/012

ISSUED DATE: August 20, 2021

APPENDIX C. TÜV Rheinland's Report No: CN21ZH49 001. (Cont.)

Test Data / Test Plan		TÜVRheinland®	
TÜV Rheinland (Shanghai) Co., Ltd.		Document No.: TD-0189	
Protection and Control requirements for PEA Interface of Inverter based Generation Systems 2016.08		Report No:	CN21ZH49 001
Order No. :	244313300	Product:	Grid-Connected PV Inverter
Client Name :	SolaX Power Network Technology (Zhejiang)Co.,Ltd	Model designation:	X3-Hybrid G4

## Attachment : 1



Used equipment No.: See equipment list for details

Sample No.: N/A

Finished date:

Tested by:

Review date:

Reviewed by:



# Compliance Evaluation Report



REPORT No.: CSSC/BOS/012

ISSUED DATE: August 20, 2021

APPENDIX C. TÜV Rheinland's Report No: CN21ZH49 001. (Cont.)

TÜV Rheinland (Shanghai) Co. Ltd.

QMA 30.041.01SHG\_7.14



Revision: 20 July, 2007/G.Luebken

## Measurement and Test Equipment List Used MTE

Attachment: 2

Report No.: CN21ZH49 001

Order No.: 244313300

Equip.	Description	Model	Manufacturer
9017073	Power Analyser(DEWETRON)	DEWE2-PA7	Austria, DEWETRON
9017074	Current Sensor(For WT3000)	IT 200-S	LEM
9017075	Current Sensor(For WT3000)	IT 200-S	LEM
9017076	Current Sensor(For WT3000)	IT 200-S	LEM
9017077	Current Sensor(For WT3000)	IT 200-S	LEM
9017078	Programmable AC Source(61860)	61860	Chroma ATE INC.
9017080	Oscilloscope	MD03024	Tektronix
G1819265	ScopeCoder	DL850	JAPAN, Yokogawa
G1819266	Power Analyser(WT3000)	WT3000	JAPAN, Yokogawa
G1819267	T-Power Software	TP100-PLVHA/STP	JAPAN, Yokogawa
G1819268	Anti-islanding test detection devices	ACLT-4830H	QUNLING Energy Resources
G1819269	Harmonic impedance analog flicker system	ACLT-6150	QUNLING Energy Resources
G1819277	PV array simulator	62150H-1000S	Chroma Co.
G1819278	PV array simulator	62150H-1000S	Chroma Co.
G1819279	PV array simulator	62150H-1000S	Chroma Co.
G1819280	PV array simulator	62150H-1000S	Chroma Co.

Used equipment No.: See equipment list for details

Sample No.: N/A

Finished date:

Tested by:

Review date:

Reviewed by:



# Compliance Evaluation Report



REPORT No.: CSSC/BOS/012

ISSUED DATE: August 20, 2021

APPENDIX C. TÜV Rheinland's Report No: CN21ZH49 001. (Cont.)

**Attachment 3:** Photo Documents  
**Report Number:** CN21ZH49 0001  
**Model:** X3-Hybrid-15.0





# Compliance Evaluation Report



REPORT No.: CSSC/BOS/012

ISSUED DATE: August 20, 2021

APPENDIX C. TÜV Rheinland's Report No: CN21ZH49 001. (Cont.)

**Attachment 3:** Photo Documents  
**Report Number:** CN21ZH49 0001  
**Model:** X3-Hybrid-15.0



Page 138 of 139



Page 214 of 216



# Compliance Evaluation Report



REPORT No.: CSSC/BOS/012

ISSUED DATE: August 20, 2021

APPENDIX C. TÜV Rheinland's Report No: CN21ZH49 001. (Cont.)

**Attachment 3:** Photo Documents  
**Report Number:** CN21ZH49 0001  
**Model:** X3-Hybrid-15.0

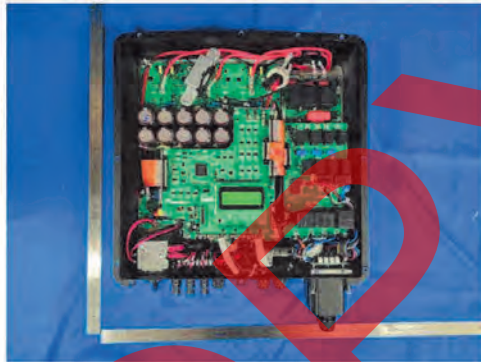

**COPY**  
Ref No.: 949





# Compliance Evaluation Report



REPORT No.: CSSC/BOS/012

ISSUED DATE: August 20, 2021

APPENDIX D. Laboratory Accreditation Certificate No. CNAS L3038



## China National Accreditation Service for Conformity Assessment LABORATORY ACCREDITATION CERTIFICATE (Registration No. CNAS L3038 )

**TUV Rheinland (Shanghai) Co., Ltd.**

*(Legal Entity: TUV Rheinland (Shanghai) Co., Ltd.)*

1/F. of No.10, No.153/165/177/178/179/182/189/192/198, Lane 777,

Guangzhong West Road, Jing'an District, Shanghai, China

*is accredited in accordance with ISO/IEC 17025:2017 General Requirements for the Competence of Testing and Calibration Laboratories(CNAS-CL01 Accreditation Criteria for the Competence of Testing and Calibration Laboratories) for the competence to undertake the service described in the schedule attached to this certificate.*

*The scope of accreditation is detailed in the attached schedule bearing the same registration number as above. The schedule forms an integral part of this certificate.*

Effective Date: 2019-10-30

Expiry Date: 2023-11-18

Signed on behalf of China National Accreditation Service for Conformity Assessment

China National Accreditation Service for Conformity Assessment (CNAS) is authorized by Certification and Accreditation Administration of the People's Republic of China (CNCA) to operate the national accreditation schemes for conformity assessment. CNAS is a signatory of the International Laboratory Accreditation Cooperation Mutual Recognition Arrangement (ILAC MRA) and the Asia Pacific Accreditation Cooperation Mutual Recognition Arrangement (APAC MRA).  
The validity of the certificate can be checked on CNAS website at <http://www.cnas.org.cn/english/findanaccreditedbody/index.shtml>.

